



**Floors, Walls & Finishes Solutions**  
2026 Collection

**Gerflor®**

## Formats

With foam backing (Comfort)



Without foam backing (Compact)

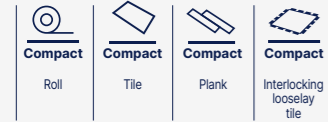

## Performances

**17 dB**

Sound insulation in dB  
(EN ISO 717-2)

**R10**

Slip resistance wet  
(DIN 51130)

**10<sup>5</sup>**

Electrical resistance in Ω :  
5 × 10<sup>4</sup> ≤ R ≤ 10<sup>6</sup>  
(EN 1081/DIN 51953)

**10<sup>7</sup>**

Electrical resistance in Ω :  
10<sup>6</sup> ≤ R ≤ 10<sup>8</sup>  
(EN 1081/DIN 51953)



Very high density foam



**100% recyclable**

## Treatments

**evercare™**

Micro structured cross coat  
Polimerised laser technology

**PROTECSOL<sup>2</sup>**

Polyurethane surface  
Treatment UV cured  
Stain shield  
Matt effect

**ProtecSol®**

ProtecSol® Mat  
Polyurethane surface  
Treatment UV cured

**ProtecShield™**

**Pur+ Matt**  
Polyurethane surface  
treatment  
Matt surface

**Pur+**

Polyurethane surface  
treatment

**Pur**

Polyurethane surface  
treatment

**Sparclean®**

Powder coated  
treatment

**neocare™**

New exclusive  
Linoleum surface protection

## Certification



Scale reduction for Wood designs.  
The images of floorcoverings in this catalogue have been reproduced as faithfully as printing technology permits.

Creation 40/55  
Tamo Clear

## 8-23. Premium

Poesy  
Neopolis  
Metallica  
Osmoz  
Indiana  
Brazilia  
Neoterra  
Cocoon  
Premium ZERO

## 24-51. Mipolam Homogeneous

**Evercare™**

Mipolam Symbioz™  
Mipolam Planet & Bioplanet  
Mipolam Affinity  
Mipolam Accord  
Mipolam Troplan

**Easycare**

Mipolam Astro **New**

**PUR**

Mipolam Classic

## 52-103. Taralay Multilayered

Taralay Millenium

Taralay Libertex **New**

Taralay Impression  
Taralay Impression **hop**

My Taralay Impression

Taralay Initial **New**

## 104-183. Creation Tiles & Planks

Creation 30/40/55/70 Dry Back **New**

Creation 40/55/70 Clic **New**

Creation 40/55 Clic Acoustic **New**

Creation 55 Looselay / Looselay  
Acoustic  
Creation 70 Looselay  
Creation Saga<sup>2</sup>

Creation 70 Connect  
Creation 70 Megaclac **New**

Creation 40/55/70 Zen

My Creation  
My Creation Zen  
My Saga

## 184-195. Carpet Tiles

Armonia 400

Armonia 540 **New** /620

## 196-211. Wall Solutions

Wall panels & tiles

Mural Revela **New**

Mural Revela accessories **New**

Wall coverings

Mural Ultra Design

Mural Club

Mural Calypso

## 212-233. Fast Track High Traffic Tiles

**GTI° Max**

**GTI° Pure**

**GTI° EL5**

**Attraction®**

Design tile

R-tile

## 234-253. Technical solutions

**EL5 / EL7 solutions  
(Dissipative & conductive floors)**

Mipolam EL7  
Mipolam Robust EL7  
Mipolam EL5  
Mipolam Technic EL5  
GTI° EL5

**Safety flooring**

Tarasafe Ultra  
Tarasafe Standard  
Tarasafe Plus/Super  
Tarasafe H<sub>2</sub>O  
Tarasafe Ultra H<sub>2</sub>O

**Shower System**

Tarasafe Ultra H<sub>2</sub>O  
Tarasafe Design  
Mural Calypso

## 254-283. DLW Linoleum

**Compact Linoleum**

Marmorette  
Colorette  
Uni Walton  
Lino Art Urban  
Lino Art Moon **New**

**Acoustic Linoleum**

Marmorette Acoustic  
Marmorette Acoustic Plus  
Colorette Acoustic Plus  
Uni Walton Acoustic Plus

**Technical Solutions**

High mechanical Traffic Linodur  
Dissipative Linoleum Marmorette LCH

## 284-329. Sport flooring

**Taraflex®**

Synthetic Sport Flooring

**Connor Sports® Aspire | **New****

Engineered wood Flooring Systems

**Sport Court®**

Outdoor Surfaces

**DLW**

Linoleum Sport Flooring

**Powershock**

Fitness Rubber Solutions

## 330-363. Finishes

**Finishes**

Skirting solutions  
Stair solutions  
Profile solutions  
Welding solutions  
Entrance mats solutions

**Installation solutions**

Shower system  
Accessibility  
Acoustic underlayers  
Specific products  
Adhesives and tapes

**Sport finishes**

Paint and marking for boundary lines

## 364-371. Specifications

# Gerflor, a world of added value solutions

Gerflor solutions are part of our everyday lives - whether at home, in sports facilities, healthcare centers, schools, workplaces, public spaces, or transportation hubs. Gerflor teams are committed to protecting the health and well-being of people and future generations.

## Strong local footprints

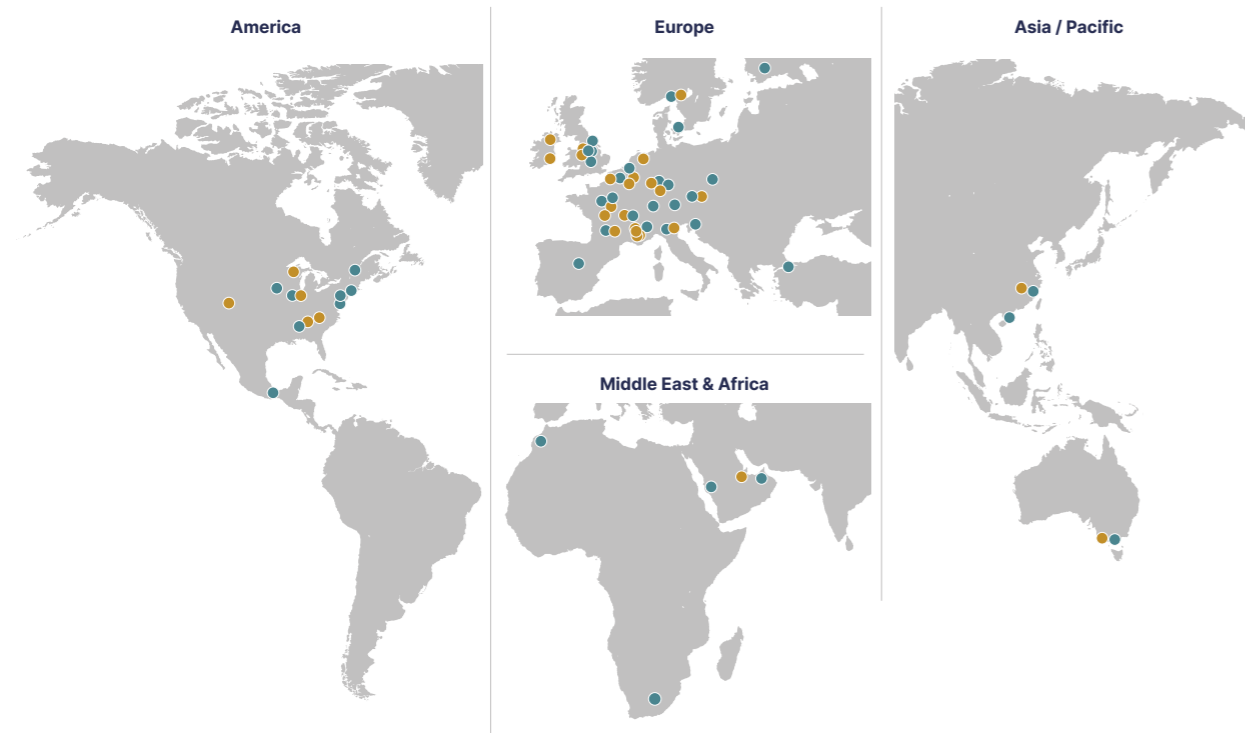

● Sales offices ● Manufacturing Plants (20) & Logistic Hubs (10)

**5500** employees    **40** sales offices    **30** manufacturing plants and logistic hubs    **5** technocentres

 Industry	 Healthcare	 Hospitality	 Offices	 Sport
 Education	 Retail	 Transport	 Housing	 Public Housing

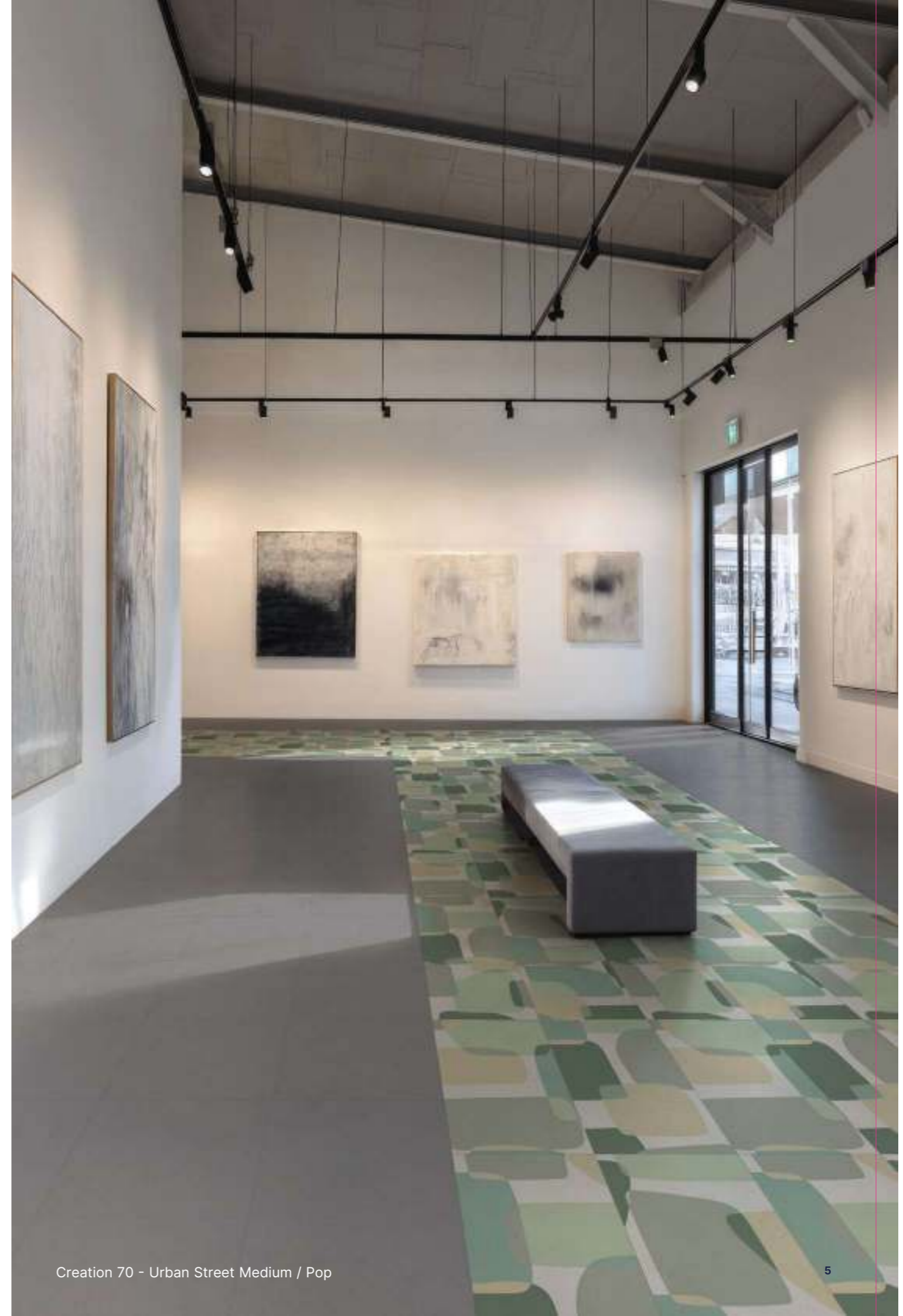

# Our commitments for a more sustainable future

## 2030 Targets



### we care for climate

we act with an ambitious decarbonization roadmap

**-30% CO<sub>2</sub>**

scopes 1, 2, 3 in tons eq CO<sub>2</sub>, vs 2019. Science Based Targets<sup>(1)</sup>



### we care for resources

we act with a more responsible sourcing

**75%**

biobased, mineral and recycled content<sup>(2)</sup>

**30%**

recycled content<sup>(3)</sup>



### we care for circularity

we act by closing the loop and reducing waste

**65 000 tons**

annual volume recycled<sup>(4)</sup>

**45%**

looselay<sup>(5)</sup>



### we care for your health and well-being

we act by creating safe and comfortable environments

**100%**

products better than Indoor Air Quality standards<sup>(6)</sup>

**95%**

sales covered by EPD<sup>(7)</sup>



### we care for people

we act by offering a safe and inclusive workspace

**30%**

women<sup>(8)</sup>

**40%**

internal mobility<sup>(9)</sup>

**Towards 0**

accident<sup>(10)</sup>

#### More details:

- Scopes 1, 2 & 3, in absolute value, market-based. Trajectory approved by SBTi (Science Based Targets Initiative).
- Origin of raw materials for the entire Floor & Wall portfolio, on average, by weight; including 15% virgin salt, a primary element in vinyl manufacturing. Compared to 71% in 2024.
- Average content in the Floor & Wall vinyl portfolio, by weight. Compared to 21% in 2024.
- Recycled in our factories and recycling units. Compared to 59 040 tons in 2024.
- % of Floor activity with non-glued products, easy to remove, easy to re-use. Compared to 40% in 2024.
- 100% of vinyl and linoleum sold to the building market below 100 micrograms /m<sup>2</sup> (TVOC 28 days).
- % of Floor & Wall activity covered by Environmental Product Declarations (EPD). Compared to 44% in 2024.
- % women in our global workforce and among our managers. Compared to respectively 26% and 27% in 2024.
- % job openings filled with internal hires worldwide. Compared to 25% in 2024.
- Towards 0 accident: Lost time accident per million hours worked: below 3 vs 8,9 in 2024, for Gerflor employees worldwide.



we care / we act



# Premium

pages 8-23

## 8. Premium

- 14. Poesy
- 15. Neopolis
- 16. Metallica
- 17. Osmoz
- 18. Indiana
- 19. Brazilia
- 20. Cocoon
- 21. Neoterra

## 22. Premium ZERO

nursery

# Premium

New collection

## More sustainable materials

# 80%

### Biocontent, Mineral & Recycled

Premium contains 20% crop residues from responsible sources. We recycle discarded soy waste from the animal feed industry. The result: less fossil based material and less carbon.

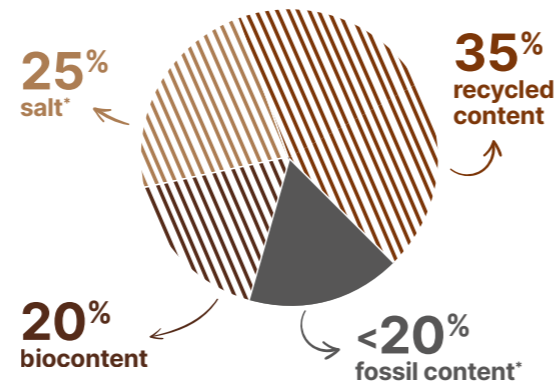

## Low carbon solution



Thanks to its improved composition, Premium emits 29%\*\* less CO<sub>2</sub> than the average heterogeneous floorings.

**A good choice to decarbonise your projects.**

\* Vinyl is made of two main ingredients: ethylen and salt.  
\*\* Based on life cycle assessment certified by UL for an average heterogeneous product.



## To go a step forwards Premium Zero

### Towards a world with 0 fossil extraction

**More than 95% of natural, recycled and bio-attributed content.**  
Available on demand and more details on page 54/55.

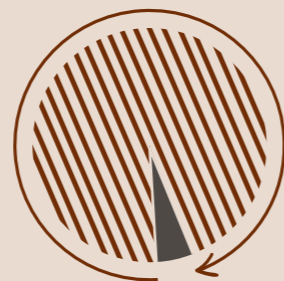

# Premium in performances

35 years of satisfied customers



## Unrivalled durability

- High density pressed wearlayer
- Pressed under 800 tons
- Immutables designs



## High resistance to heavy loads

- Double reinforcement for excellent dimensional stability
- Easy rolling

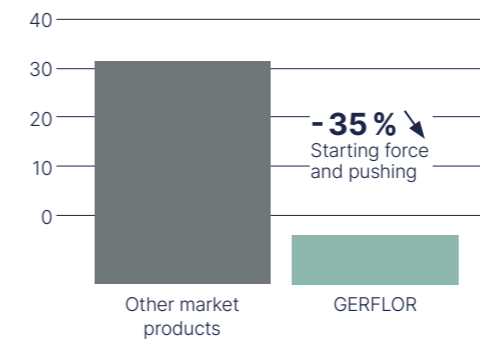

## Lower maintenance costs

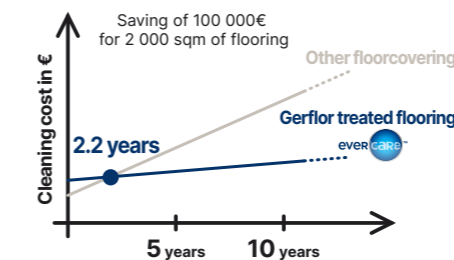

## Indoor air quality

- A+ / Floorscore / M1 certified
- Phthalate-free
- Anti-bacterial activity: ISO 22196

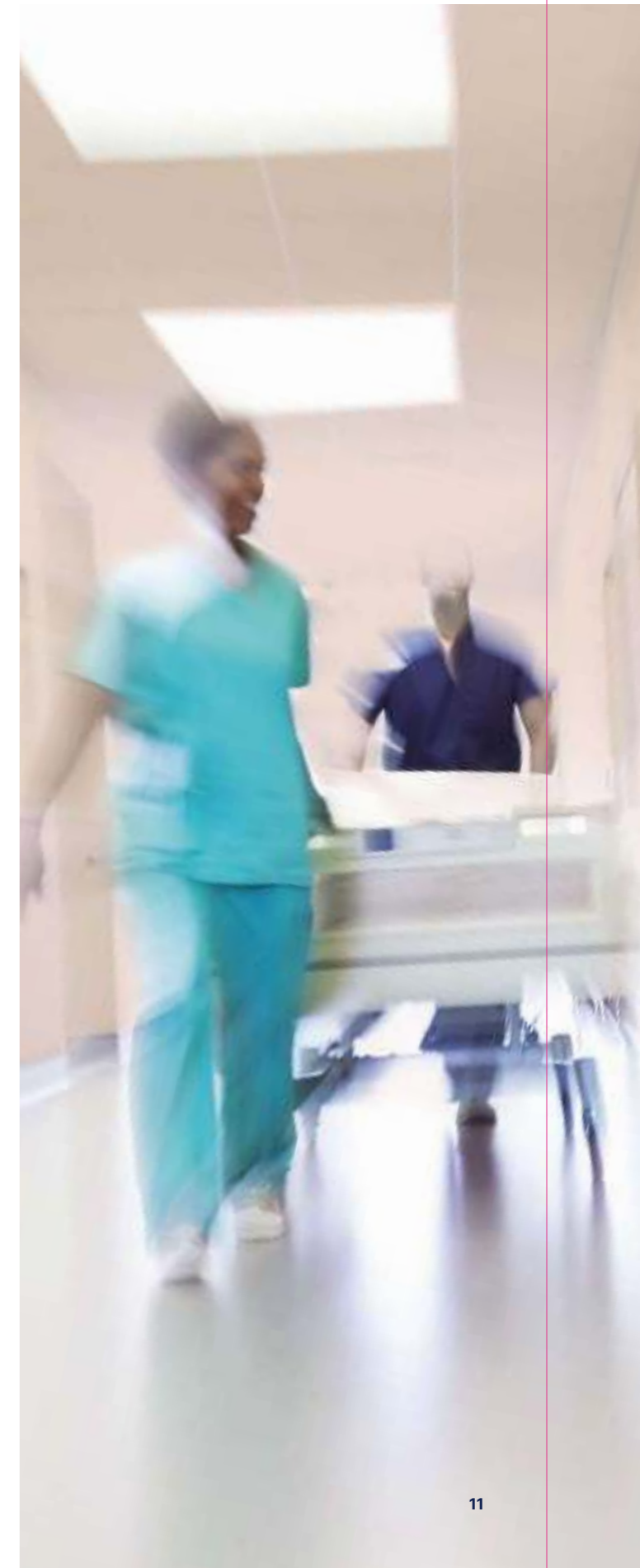

## Premium Acoustic

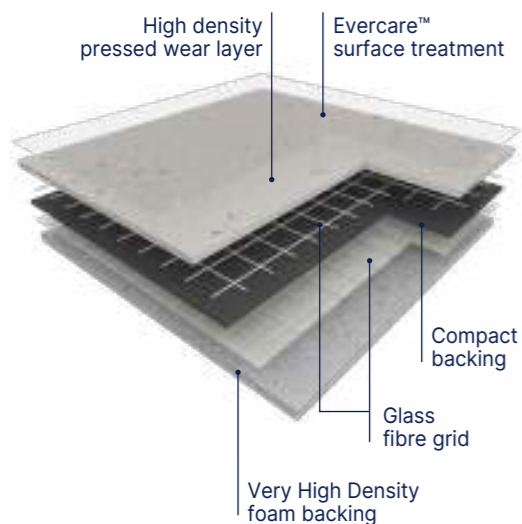

The floor covering is made of a **>1mm thick, pure vinyl homogeneous wear layer with no filler, incorporating very densely pressed coloured chips, with a mat finishing and without a transparent wear layer.**

It offers a T group wear rating and is available in 2 m wide sheet. The product contains a compact backing which is calendared, pressed and a Very High Density (VHD) foam backing. It is reinforced with a double glass fibre grid.

It offers a **16 dB sound insulation, an indentation resistance of 0.06 mm and a rolling heavy loads easiness.**

**PREMIUM COMFORT** is treated with **Evercare™**, a surface treatment obtained by UV laser crosslinking. It ensures easy maintenance and eliminates permanently the need for acrylic emulsion (metallisation). It avoids staining of chemical products used in healthcare like iodine alcohol, Betadine, eosin and anti-bacterial hand gel.

According to ISO 21702, **PREMIUM COMFORT** has **anti viral activity** against Human Coronaviruses: it reduces the number of virus by 99,7% after 2h00. According to ISO 22196, it has **anti bacterial activity** against E. coli, S. aureus and MRSA of 99% after 24h00.

It is 100% compliant with REACH. It is composed of 40% of minerals and inexhaustible materials. It is made with more than 50% recycled content; 100% of which are fully controlled and REACH compliant. It does not contain any heavy metals, any formaldehydes and it is made with phthalate free plasticizers. The products emission rate of volatile organic compounds is **<10µg/m³ (TVOC after 28 days – ISO 16000-6)**. It is 100% recyclable.

## Premium Compact

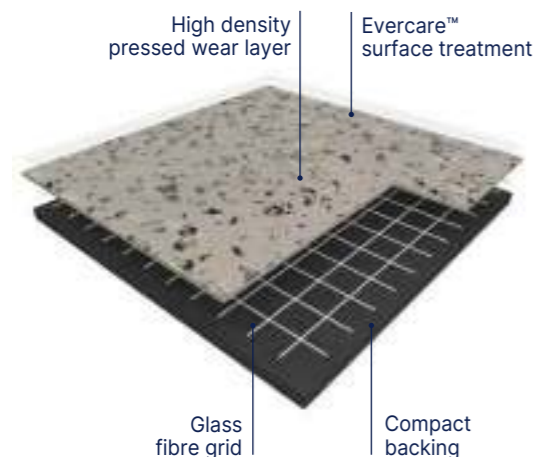

Our **PREMIUM COMPACT** is made of a **>1mm thick, pure inlaid wearlayer pressed under 800 tonnes with no filler, incorporating very densely pressed coloured chips, with a mat finishing and without a transparent wear layer.** It offers a T group wear rating and is available in 2 m wide sheet. Its compact backing is calendared, pressed and reinforced with a fiber grid yielding. It offers a **8 dB sound insulation, an indentation resistance of 0.02 mm and a rolling heavy loads easiness.**

**PREMIUM COMPACT** is treated with **Evercare™**, patented surface treatment obtained by UV laser cross-linking offering the best chemical resistance to the main products used in healthcare environment as betadine, eosin, hydro alcoholic solutions, making the maintenance easy and the floor long lasting. This treatment avoids applying any acrylic emulsion throughout the lifetime of the product.

According to ISO 21702, **PREMIUM COMPACT** has **anti viral activity** against Human Coronaviruses: it reduces the number of virus by 99,7% after 2h00.

According to ISO 22196, it has **anti bacterial activity** against E. coli, S. aureus and MRSA of 99% after 24h00.

It is composed of: 42% of recycled content / 19% of bio-sourced raw material (from agricultural vegetal waste) / 56% of mineral raw material ; 100% of which are fully controlled and REACH compliant.

It is free of formaldehyde, heavy metals and CMR 1 & 2 or vPvB (very persistent and very bio accumulative) or PBT (persistent, bio-accumulative and toxic) and is 100% REACH compliant. **Its VOC emissions after 28 days (ISO 16000-6) are below detection levels (<10 µg / m³) and this product is classified A + (the best class) and Floorscore® & M1 certified for indoor air quality.** **PREMIUM COMPACT** has antibacterial efficacy (E.coli / S.aureus / MRSA): >99% after 24 hours according to ISO22196.

**PREMIUM COMPACT is made in France, is 100% recyclable, and the floorcovering will have its individual EPD sheet** (number 4790130460.106.2).



### • Outstanding durability

Design within the whole thickness of the wear layer,  $\geq 1.02$  mm thick

### • Long lasting appearance

Pure vinyl wear layer (no filler, no transparent wear layer) for the best scratch and soiling resistance

### • Easy maintenance & matt effect

Evercare™ surface treatment

### • Excellent indoor air quality

TVOC after 28 days < 10 microgram/m³

### • Rolling heavy loads easiness, best stability and very high performance indentation / acoustic 0.06 mm / 17 dB (Metallica: 16 dB) for Comfort, 0.02 mm / 8 db for Compact Glass fibre grid reinforcement & very high density foam backing

Description	Premium Acoustic		Premium Compact	
	Brazilia / Indiana / Cocoon / Neopolis / Osmoz / Poesy / Neoterra - Metallica		Brazilia / Indiana / Cocoon / Neopolis / Osmoz / Poesy / Neoterra - Metallica	
Total thickness	EN ISO 24346	mm	3.00 - 3.30	2.00
Thickness of wearlayer	EN ISO 24340	mm	$\geq 1.02$	$\geq 1.02$
Weight	EN ISO 23997	g/sqm	$\geq 2800$	2580 - 2620
Width of sheet	EN ISO 24341	cm	200	200
Length of sheet	EN ISO 24341	lm	25	20
Phthalate free	-	-	OK	OK
<b>Classification</b>				
Norm / Product specification	-	-	EN ISO 11638	EN ISO 10582
European classification	EN ISO 10874	class	34-42	34-43
Fire rating	EN 13501-1	class	Cfl-s1	Bfl-s1
Static electrical propensity	EN 1815	kV	< 2	< 2
Slip resistance	EN 16165:2021 – Appendix B (DIN 51 130)	class	R10	R10
<b>Performances</b>				
Wear resistance	EN 660.2	mm³	$\leq 2.0$	$\leq 2.0$
Wear group	-	group	T	T
Type Binder content	EN ISO 10582	type	-	I
Dimensional stability	EN ISO 23999	%	$\leq 0.40$	$\leq 0.40$
Residual indentation (requirement)	EN ISO 24343-1	mm	$\leq 0.20$	$\leq 0.10$
Residual indentation (average measured value)	-	mm	$\approx 0.06$	$\approx 0.02$
Impact sound insulation	EN ISO 717-2	dB	17 16 (Metallica)	8
Castor chair test (type H)	ISO 4918	-	OK	OK
Thermal conductivity	EN ISO 10456	W/(m.k)	0.25	0.25
Colour fastness	EN ISO 105-B02	degree	$\geq 6$	$\geq 6$
Surface treatment	-	-	Evercare™	Evercare™
Chemical products resistance <sup>(1)</sup>	EN ISO 26987	-	OK	OK
<b>Environment</b>				
Recycled content (average)	-	%	25	43
Recyclability	-	%	100	100
EPD	-	-	Available	Available
<b>Health</b>				
Anti-bacterial activity (E. coli - S. aureus - MRSA) after 24h <sup>(2)</sup>	ISO 22196	-	> 99% inhibits growth	> 99% inhibits growth
Anti-viral activity (human coronavirus) after 2h <sup>(2)</sup>	ISO 21702	-	> 99.7% virucidal activity	> 99.7% virucidal activity
TVOC after 28 days	ISO 16000-6	microgram/m³	< 10	< 10
Certification	-	-	Floorscore®	Floorscore®
<b>CE marking</b>				



(1) Regarding the resistance to chemicals, please download the corresponding leaflet from our website.  
 (2) The implementation of an effective cleaning regime is the most important defence against infection.



# Premium

## Poesy

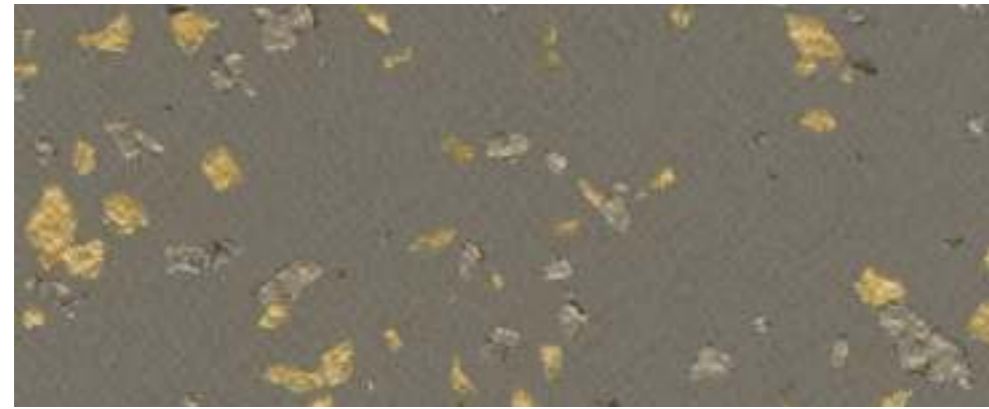

 17 dB
 
 Evercare™
 
 100% recyclable



2749 Lyrique  



^ Scale 1



2752 Litote  





2751 Slam  



POESY 2749 Lyrique / METALLICA 8257 Nyx



2748 Refrain  



2750 Ellipse  





2747 Ballade  





8621 Ode  



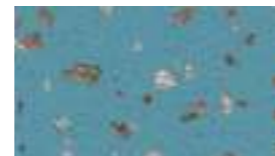

2151 Sonate  



8627 Allegorie  





2152 Octave  





2501 Rhapsody  





8626 Rime  



## Neopolis



 17 dB
 
 Evercare™
 
 100% recyclable

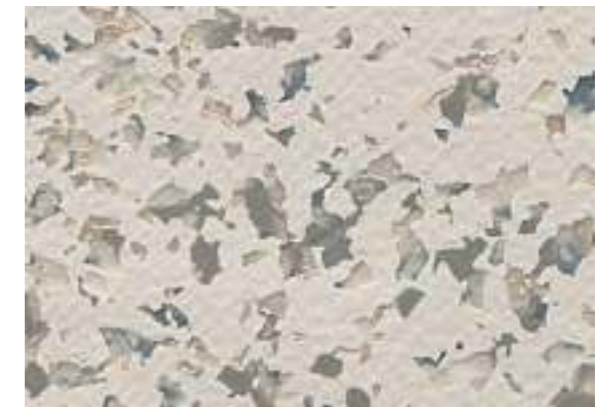

2743 Central Park



2743 Central Park  



^ Scale 1

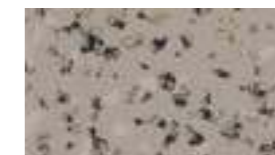

2744 Queens Soft  





2745 Plaza  





2741 Brooklyn  



2740 Harlem Soft  



2742 Times Square  

# Premium

## Metallica



**16 dB**

**Evercare™**

**100% recyclable**



0062 Beyla



0062 Beyla ^ Scale 1





0061 Eldir 



0060 Dellig 



9753 Energy  



9745 Cosmic 



0064 Sudri  



0063 Narfi 



8257 Nyx 



2746 Ymir 

## Osmoz



**17 dB**

**Evercare™**

**100% recyclable**



4364 Ivory / 4379 Koudou



4364 Ivory ^ Scale 1

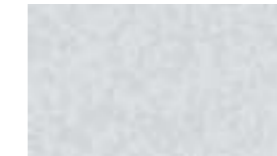

4378 Igloo  

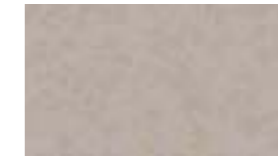

4349 Angora  

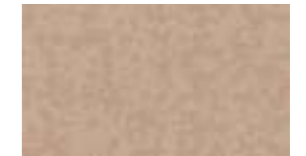

4379 Koudou 

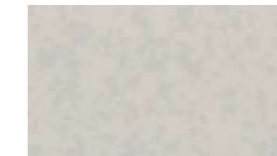

4365 Alpaga  



4380 Awara 



4384 Barbadine 



3792 Storm Grey 





4381 Rozelle 



4383 Jasmin 



3791 Slate Grey  



4351 Greige 



4382 Cyclades  



7737 Pepper Grey 

# Premium

## Indiana

Compact Acoustic 17 dB VHD Evercare™ 100% recyclable



8226 Fidji ^ Scale 1  
⓪ ⓪



8150 Bali  
⓪



4048 Malabo  
⓪



4045 Dalupiri  
⓪



4001 Ofu  
⓪ ⓪



4343 Tokelau  
⓪ ⓪



4049 Kilmia  
⓪



7517 Faroe  
⓪



4009 Tufoa  
⓪ ⓪



4052 Calero  
⓪ ⓪



4050 Comores  
⓪



4047 Okuza  
⓪ ⓪



4002 Manua  
⓪ ⓪



4053 Diwaran  
⓪ ⓪



4051 Maraca  
⓪



4476 Wattaru  
⓪



4046 Cubagua  
⓪



8837 Songo  
⓪



4003 Tao  
⓪

## Brazilia

Compact Acoustic 17 dB VHD Evercare™ 100% recyclable



8386 Boa Vista ^ Scale 1  
⓪ ⓪



0051 Alvorada  
⓪ ⓪



0053 Limeira  
⓪



0058 Aracaju / 8386 Boa Vista / 0054 Barueri



0056 Natal  
⓪



0052 Olinda  
⓪



4477 Maceio  
⓪



0054 Barueri  
⓪



0058 Aracaju  
⓪



0055 Teresina  
⓪



8736 Recife  
⓪ ⓪



3707 Paraiba  
⓪



3709 Ceara  
⓪

# Premium

## Cocoon

Compact Acoustic 17 dB VHD Evercare™ 100% recyclable



0032 Satin / 0030 Crinolin /  
0027 Muslin / 0028 Organza

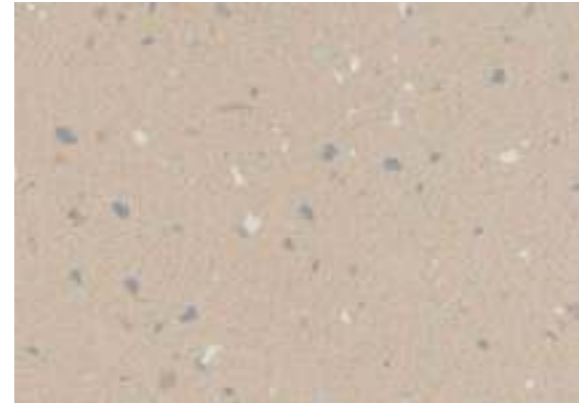

0032 Satin ^ Scale 1



0030 Crinolin



0027 Muslin



0029 Flannel



0028 Organza

## Neoterra

Compact Acoustic 17 dB VHD Evercare™ 100% recyclable



NEOTERRA 4208 Dorata / INDIANA 4052 Calero



4208 Dorata ^ Scale 1



4207 Prato



4208 Soraya



4206 Lazuli

# Premium ZERO

Facing the urgent challenges of climate change and resource scarcity, we are committed to reducing the environmental impact of our products.

Together, let's build a more sustainable future, one step at a time.

**we care / we act**

## Towards ZERO carbon

The innovative Premium ZERO formula further strengthens our commitment to reducing carbon footprints and supports your projects where very low carbon materials are required.

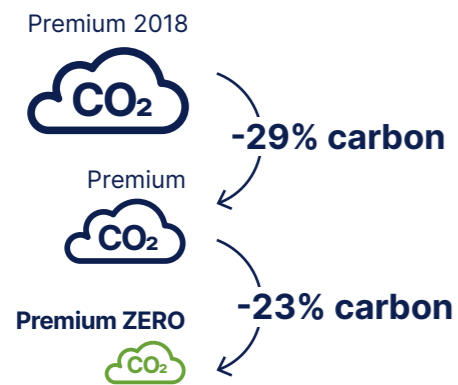

Thanks to its pioneering composition, Premium ZERO Compact carbon footprint is only 4kg eq CO<sub>2</sub>/sqm (based on 1 year life cycle) and 7kg eq CO<sub>2</sub>/sqm (based on 25 years life cycle)



EPD available certified by UL.

**Product available on demand.**

For more information, please contact your Gerflor representative

## Towards ZERO fossil extraction

Premium ZERO is a new generation of flooring that's leading the way towards using zero virgin ingredients and achieving zero fossil extraction.

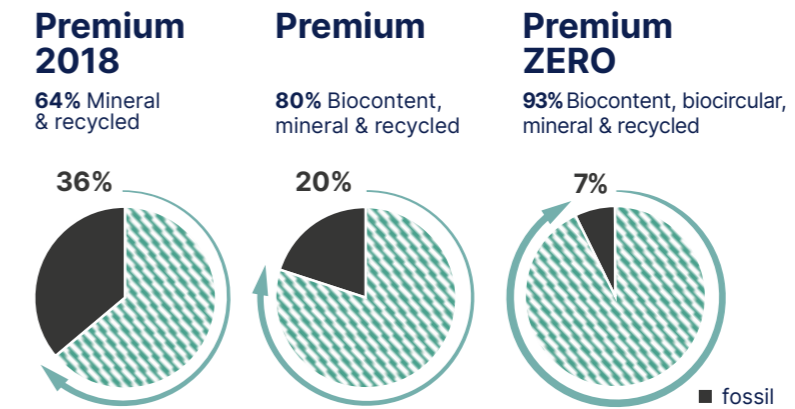

## Inside Premium ZERO: one step further



### Biocontent

Ingredients made from soy residues, turning agricultural waste into a valuable resource that ensures product flexibility.



### Biocircular

Vinyl made from renewable sources like used cooking oil, reducing reliance on fossil fuels while maintaining quality. Third-party certified (ISCC Plus) according to a mass balance approach.

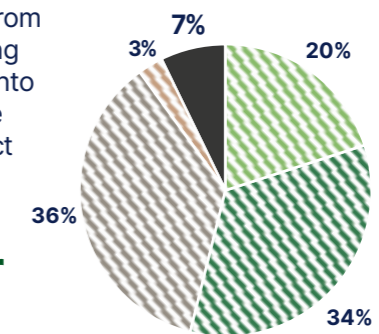

■ biocontent ■ biocircular ■ recycled ■ mineral



# Mipolam Homogeneous

pages 24-51

Mipolam  
Homogeneous

- 28. Mipolam Homogeneous Evercare™**
  - 30. Mipolam Symbioz™
  - 34. Mipolam Planet & Bioplanet
  - 38. Mipolam Affinity
  - 42. Mipolam Accord
  - 44. Mipolam Troplan
- 46. Mipolam Homogeneous Easycare**
  - 48. Mipolam Astro **New**
- 50. Mipolam Homogeneous PUR**
  - 50. Mipolam Classic

# Mipolam Homogeneous

Type Binder content EN ISO 10581

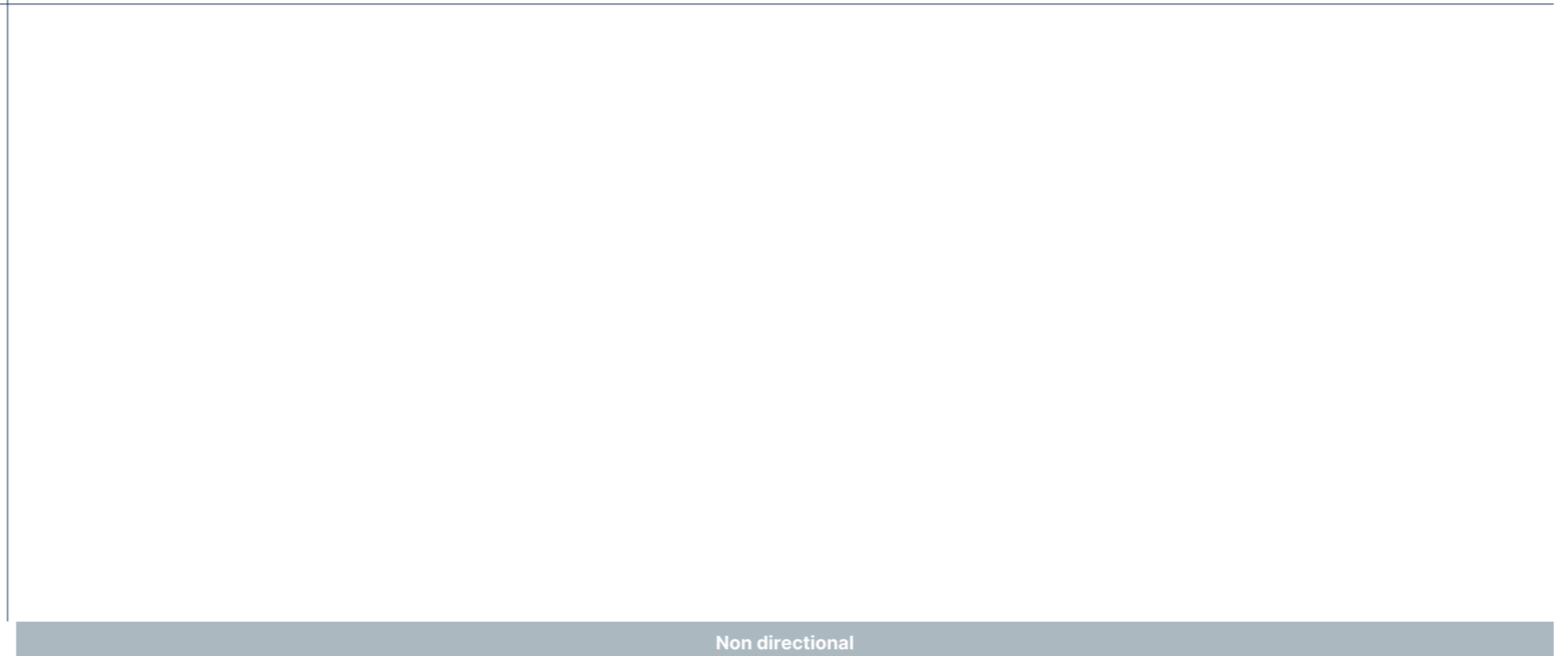
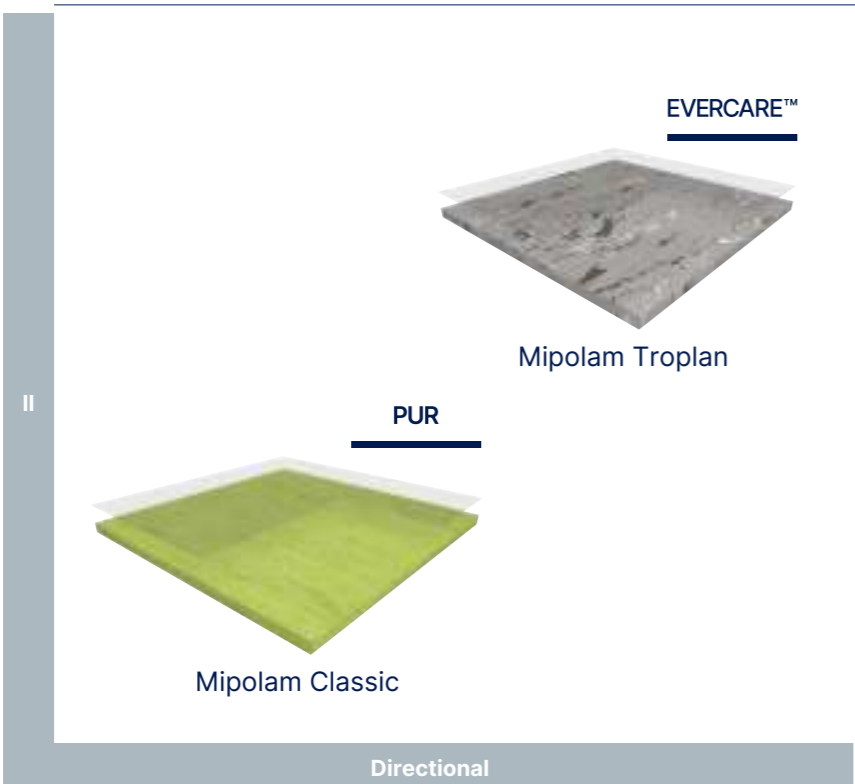
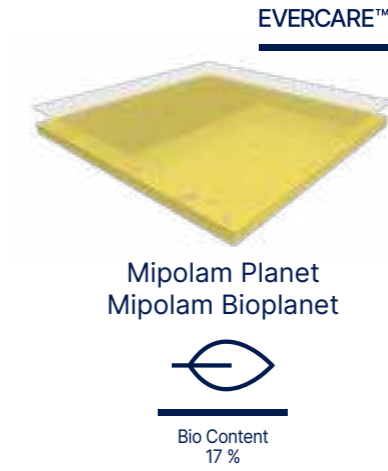
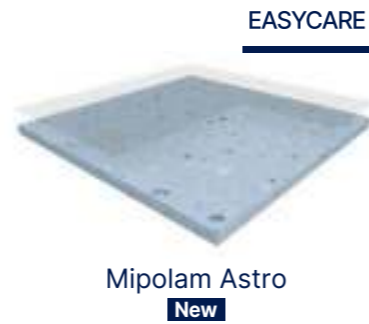
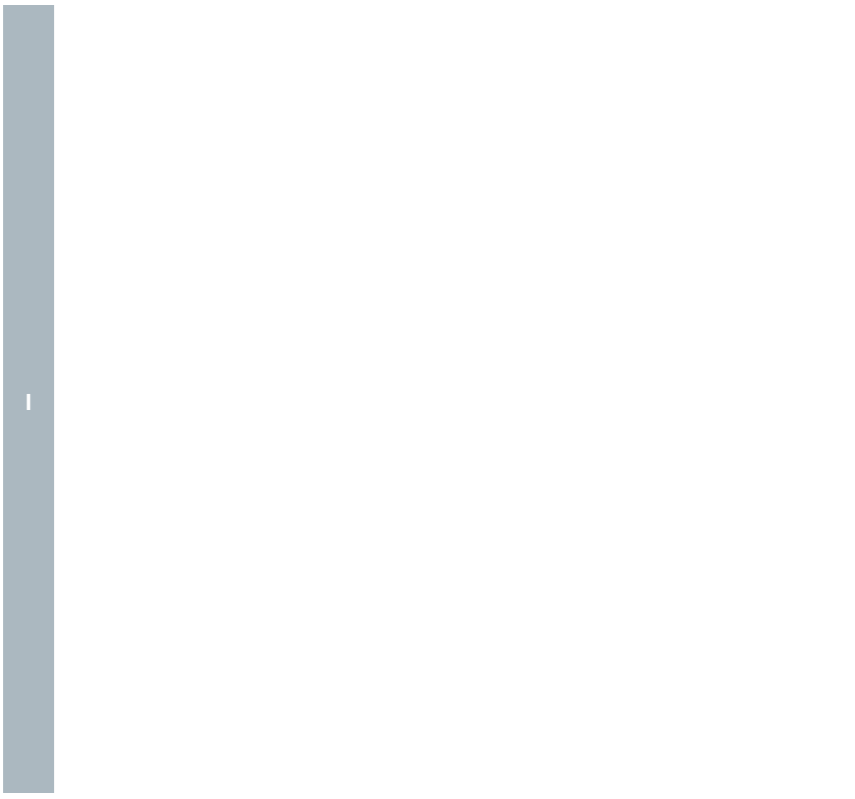

Maintenance

Mipolam Homogeneous

# Mipolam Homogeneous Evercare™

## Mipolam Symbioz™

Mipolam Symbioz™

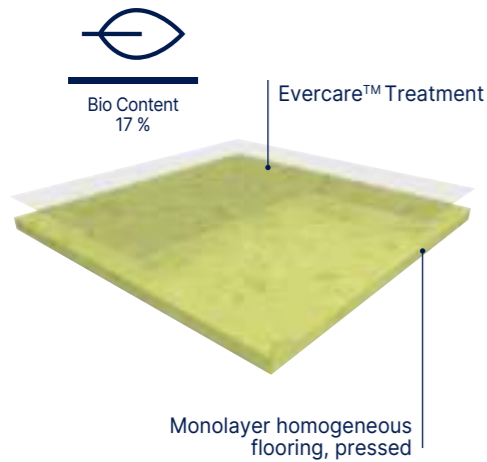

**MIPOLAM SYMBIOZ™** is fully flexible homogeneous compacted floorcovering in sheet, 2m wide, providing excellent resistance to wear and tear in high traffic areas. Their weight is **2595 gr/m²**. They feature a non-directional design incorporating coloured chips to ensure an even colour throughout the thickness presenting a **nice matt finish**.

Comprising 83% natural and recycled content, including 17% bio content, 45% mineral raw material (Salt & chalk) and 21% recycled content, **MIPOLAM SYMBIOZ™** achieves a 20% to 30% reduction in Cradle to Gate CO2 emissions compared to standard homogeneous flooring. It is 100% phthalates free and recyclable. This floorcovering is a non-emissive product (below the level of VOC measurement accuracy).

According to ISO 21702, **MIPOLAM SYMBIOZ™** has **anti viral activity** against Human Coronaviruses: it reduces the number of virus by 99,7% after 2h00.

According to ISO 22196, **MIPOLAM SYMBIOZ™** has **anti bacterial activity** against E. coli, S. aureus and MRSA of 99% after 24h00. The flooring is equipped with **Evercare™**, patented surface treatment obtained by **UV laser cross-linking** offering the **best chemical resistance to the main products used in healthcare** environment as Betadine, eosin, hydro alcoholic solutions, making the maintenance easy and long lasting the flooring.

This treatment **avoids applying any acrylic emulsion** throughout the lifetime of the product.

The flooring is **antistatic** (<2kV), its residual indentation is ≈ 0.02 mm. The flooring complies with the EN ISO 10581 norm, has a binder content Type I and is suitable for heavy duty traffic areas and **Bfl-s1 fire** resistance.

As part of our sustainable development policy, this product is manufactured in the first floor covering plant awarded with the triple certification: ISO 9001 (quality), ISO 14 001 (environment) and OHSaS 18001 (safety).



**BBR40:**  
100% Bio-based plasticizer rod for Mipolam Symbioz™  
(see page 347)



Evercare™



100% recyclable

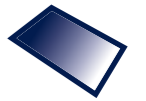

Matt finish

Mipolam Homogeneous

**Mipolam Symbioz™ have been engineered using a full life cycle model, to guarantee the lowest environmental impact at every stage of the product life**

- ▶ **Highest durability:** product life expectancy > 20 years
- ▶ **Eco-responsible exclusive Bio based plasticizer, 100% made from organic source**
- ▶ **Evercare™:** patented polyurethane surface treatment with unique performance in staining providing chemical resistance
- ▶ **Easy maintenance:** no wax for life
- ▶ **On average 30% savings on maintenance cost**
- ▶ **15% less detergent and water use.**

**Indoor Air Quality: very low emitting material (40 times lower than European standards).**

Mipolam Symbioz™			
<b>Description</b>			
Total thickness	EN ISO 24346	mm	2
Weight	EN ISO 23997	g/sqm	2595
Width of sheet	EN ISO 24341	cm	200
Length of sheet	EN ISO 24341	lm	20
Phthalate free	-	-	OK
<b>Classification</b>			
Norm / Product specification	-	-	EN ISO 10581
European classification	EN ISO 10874	class	34-43
Fire rating	EN 13501-1	class	Bfl-s1
Static electrical propensity	EN 1815	kV	< 2
Slip resistance	EN 16165:2021 – Appendix B (DIN 51 130)	class	R9
<b>Performances</b>			
Type Binder content	EN ISO 10581	type	I
Dimensional stability	EN ISO 23999	%	≤ 0.40
Impact Sound Insulation	EN ISO 717-2	dB	5
Residual indentation (norm)	EN ISO 24343-1	mm	≤ 0.10
Residual indentation (average measured value)	-	mm	≈ 0.02
Castor chair test (type H)	ISO 4918	-	OK
Thermal conductivity	EN ISO 10456	W/(m.k)	0.25
Colour fastness	EN ISO 105-B02	degree	≥ 6
Surface treatment	-	-	Evercare™
Chemical products resistance	EN ISO 26987	class	OK
<b>Environment</b>			
Recycled content (average)	-	%	25
Recyclability	-	%	100
EPD	-	-	Available
<b>Health</b>			
TVOC after 28 days	ISO 16000-6	microgram/m³	< 10
Certification	-	-	Floorscore®
Anti-bacterial activity (E. coli - S. aureus - MRSA) after 24h <sup>(1)</sup>	ISO 22196	-	> 99% inhibits growth
Anti-viral activity (human coronavirus) after 2h <sup>(1)</sup>	ISO 21702	-	> 99.7% virucidal activity
<b>CE Marking</b>			



EN 14041

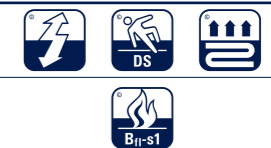

(1) The implementation of an effective cleaning regime is the most important defence against infection.

# Mipolam Homogeneous Evercare™

Mipolam Symbioz™



Evercare™



100% recyclable



Bio Content  
17%

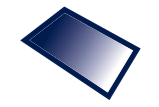

Matt finish

Mipolam  
Homogeneous



6027 Acacia



^ Scale 1



6027 Acacia

6002 Lipica 	6030 Stonehenge 		
6001 Cotton 	6009 Grey Stone 	6050 Hurricane 	6056 Tulum 
6005 Ghibli 	6008 Calico 	6036 Oceania 	6058 Vermiglio 
6031 Breeze 	6010 Mist 	6037 Lagoon 	6018 Ushuaia 
6034 Mole 	6029 Cloud 	6006 Blue Sky 	6075 Cardinal 
6041 Clay 	6039 Pebble 	6047 Sauge 	6065 Segesta 
6043 Wood 	6044 Sea Storm 	6057 Musk 	6025 Tangelo 
6045 Chocolate 	6059 Black Diamond 	6067 Kaki 	6032 Sunshine 

# Mipolam Homogeneous Evercare™

## Mipolam Planet & Bioplanet

### Mipolam Planet & Bioplanet

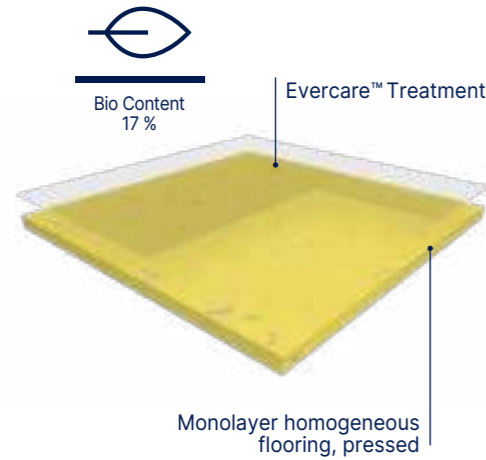

**MIPOLAM PLANET** is fully flexible homogeneous compacted floorcovering in sheet, 2 m wide, providing excellent resistance to wear and tear in high traffic areas. Their weight is **2700 gr/m<sup>2</sup>**. They feature a non-directional design incorporating translucent chips that provides a 3D effect and ensures an even colour throughout the thickness presenting a nice matt finish over 40 colours. The flooring is equipped with **Evercare™**, patented surface treatment obtained by UV laser cross-linking offering the best chemical resistance to the main products used in healthcare environment as betadine, eosin, hydro alcoholic solutions, making the maintenance easy and the floor long lasting. This treatment avoids applying any acrylic emulsion throughout the lifetime of the product. It is free of formaldehyde, heavy metals and CMR 1 & 2 or vPvB (very persistent and very bio-accumulative) or PBT (persistent, bio-accumulative and toxic) and is REACH compliant. It is **100% phthalates free and recyclable**. Its VOC emissions after 28 days (ISO 16000-6) are below detection levels (< 10 microgram/m<sup>3</sup> and g/m<sup>3</sup>) and this product is classified A + (the best class). According to ISO 21702, Mipolam Planet has **anti-viral activity** against Human Coronaviruses: it reduces the number of virus by 99.7% after 2h00. According to ISO 22196, Mipolam Planet has **anti-bacterial activity** against E. coli, S. aureus and MRSA of 99% after 24h00. The flooring is **antistatic** (< 2 kV), its residual indentation is ≈ 0.02 mm. The flooring complies with the EN ISO 10581 norm, has a binder content Type I and is suitable for heavy duty traffic areas and **Bfl-s1 fire resistance**. As part of our sustainable development policy, this product is manufactured in the first floor covering plant awarded with the triple certification: ISO 9001 (quality), ISO 14 001 (environment) and OHSaS 18001 (safety).

**MIPOLAM BIOPLANET** is fully flexible homogeneous compacted floorcovering in sheet, 2 m wide, providing excellent resistance to wear and tear in high traffic areas. Its weight is **2700 gr/m<sup>2</sup>**. It features a non-directional design incorporating translucent chips that provides a 3D effect and ensures an even colour throughout the thickness presenting a nice matt finish over 40 colours. It contains over 75% sustainable of renewable raw materials. It include a 100% bio based plasticizer, made of residues from non-agricultural food. The flooring is equipped with **Evercare™**, patented surface treatment obtained by UV laser cross-linking offering the best chemical resistance to the main products used in healthcare environment as betadine, eosin, hydro alcoholic solutions, making the maintenance easy and the floor long lasting. This treatment avoids applying any acrylic emulsion throughout the lifetime of the product. It is free of formaldehyde, heavy metals and CMR 1 & 2 or vPvB (very persistent and very bio-accumulative) or PBT (persistent, bio-accumulative and toxic) and is REACH compliant. It is **100% phthalates free and recyclable**. Its VOC emissions after 28 days (ISO 16000-6) are below detection levels (< 10 microgram/m<sup>3</sup> and g/m<sup>3</sup>) and this product is classified A + (the best class). According to ISO 21702, Mipolam Bioplanet has **anti-viral activity** against Human Coronaviruses: it reduces the number of virus by 99.7% after 2h00. According to ISO 22196, Mipolam Bioplanet has **anti-bacterial activity** against E. coli, S. aureus and MRSA of 99% after 24h00. The flooring is **antistatic** (< 2 kV), its residual indentation is ≈ 0.02 mm. The flooring complies with the EN ISO 10581 norm, has a binder content Type I and is suitable for heavy duty traffic areas and **Bfl-s1 fire resistance**. As part of our sustainable development policy, this product is manufactured in the first floor covering plant awarded with the triple certification: ISO 9001 (quality), ISO 14 001 (environment) and OHSaS 18001 (safety).



Evercare™



100% recyclable



Matt finish

- ▶ **Recycled content up to 25%, 100% Recyclable**
- ▶ **Bio content 17% (Mipolam BioPlanet - on demand)**
- ▶ **Anti-viral activity & Anti-bacterial activity**  
Indoor air quality: TVOC 100 times below standard
- ▶ **40 COLOURS: Bright and subtle non directional design**
- ▶ **Heavy traffic resistance**
- ▶ **Ease of maintenance thanks to Evercare™**

			Mipolam Planet	Mipolam BioPlanet	Mipolam Planet R10
<b>Description</b>					
Total thickness	EN ISO 24346	mm	2	2	2
Weight	EN ISO 23997	g/sqm	2700	2700	2700
Width of sheet	EN ISO 24341	cm	200	200	200
Tile size	EN ISO 24342	mm	608 × 608 <sup>(1)</sup>	608 × 608 <sup>(1)</sup>	608 × 608 <sup>(1)</sup>
Length of sheet	EN ISO 24341	lm	20	20	20
Phthalate free	-	-	OK	OK	OK
<b>Classification</b>					
Norm / Product specification	-	-	EN ISO 10581	EN ISO 10581	EN ISO 10581
European classification	EN ISO 10874	class	34-43	34-43	34-43
Fire rating	EN 13501-1	class	Bfl-s1	Bfl-s1	Bfl-s1
Static electrical propensity	EN 1815	kV	< 2	< 2	< 2
Slip resistance	EN 16165:2021 – Appendix B (DIN 51 130)	class	R9	R9	R10
<b>Performances</b>					
Type Binder content	EN ISO 10581	type	I	I	I
Dimensional stability	EN ISO 23999	%	sheet < 0.40	sheet < 0.40	sheet < 0.40
Dimensional stability (average measured value)	-	%	sheet ≈ 0.10	sheet ≈ 0.10	sheet ≈ 0.10
Impact Sound Insulation	EN ISO 717-2	dB	5	5	5
Residual indentation (norm)	EN ISO 24343-1	mm	≤ 0.10	≤ 0.10	≤ 0.10
Residual indentation (average measured value)	-	mm	≈ 0.02	≈ 0.02	≈ 0.02
Castor chair test (type H)	ISO 4918	-	OK	OK	OK
Decontamination	ISO 8690	-	Excellent	Excellent	Excellent
Watertightness	EN 13553	Annex A	Pass	Pass	Pass
Thermal conductivity	EN ISO 10456	W/(m.k)	0.25	0.25	0.25
Colour fastness	EN ISO 105-B02	degree	≥ 7	≥ 7	≥ 7
Surface treatment	-	-	Evercare™	Evercare™	Evercare™
Chemical products resistance	EN ISO 26987	class	OK	OK	OK
<b>Environment</b>					
Recycled content (average)	-	%	25	25	25
Recyclability	-	%	100	100	100
EPD	-	-	Available	Available	Available
<b>Health</b>					
TVOC after 28 days	ISO 16000-6	microgram/m <sup>3</sup>	< 10	< 10	< 10
Certification	-	-	Floorscore®	Floorscore®	Floorscore®
Anti-bacterial activity (E. coli - S. aureus - MRSA) after 24h <sup>(2)</sup>	ISO 22196	-	> 99% inhibits growth	> 99% inhibits growth	> 99% inhibits growth
Anti-viral activity (human coronavirus) after 2h <sup>(2)</sup>	ISO 21702	-	> 99.7% virucidal activity	> 99.7% virucidal activity	> 99.7% virucidal activity
<b>CE Marking</b>					



EN 14041

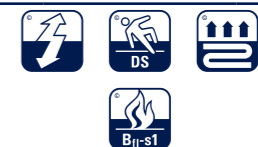

(1) Products available in tiles for a minimum quantity order of 500 sqm.

(2) The implementation of an effective cleaning regime is the most important defence against infection.

# Mipolam Homogeneous Evercare™

Mipolam Planet & Bioplanet



Evercare™



100% recyclable

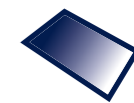

Matt finish

Mipolam  
Homogeneous



5404 Vanilla Sky



^ Scale 1



5403 Moon Dust



5402 Ivory Dust



5412 Moon Stone



5424 Hawk Eye



5441 Clay Soil



5432 Sun Stone



5418 Terra Nera



5422 Sunflower



5438 Andalusite



5428 Shedded Ground



5443 Wood Path



5445 Tree Bark



5444 Rocky Hill



5482 Sugar Drip



5406 Moqui



5430 Sideral Grey



5460 Lava Stone



5437 Reef Water



5416 Acquamarina



5450 Blended Ashes



5459 Stormy Cloud



5417 Foggy Hill



5426 Shadow



5420 Stone Powder



5429 Fog Patch



5427 Green Zest



5436 Tiger Eye



5413 Rain Fall



5439 Moon Way



5447 Aventurine



5456 Intense Indigo



5410 Silex



5411 Atlantic Grey



5455 Lava Flow



5466 Rocky Blue



5408 Chalk Dust



5409 Pebble Beach



5475 Intense Ruby



5446 Blue Nug



# Mipolam Homogeneous Evercare™

## Mipolam Affinity / Accord / Troplan

### Mipolam Affinity



**MIPOLAM AFFINITY** is a vinyl flooring homogeneous pressed in 2 m sheets, with a thickness of 2 mm and a **weight of 2800 g**. The non-directional design with colour throughout the thickness is available in 50 references presenting a contrasted designed & a **mat finish**. This flooring is recommended for collective buildings making skirtings easier, as well as angles and welding. The flooring is equipped with **Evercare™**, patented surface treatment obtained by **UV laser cross-linking** offering **the best chemical resistance to the main products used in healthcare** environment as Betadine, eosin, hydro alcoholic solutions, making the maintenance easy and the floor long lasting. This treatment **avoids applying any acrylic emulsion** throughout the lifetime of the product. According to ISO 21702, **MIPOLAM AFFINITY** has **anti-viral activity** against Human Coronaviruses: it reduces the number of virus by 99.7% after 2h. According to ISO 22196, **MIPOLAM AFFINITY** has **anti-bacterial activity** against E. coli, S. aureus and MRSA of 99% after 24h. It is free of formaldehyde, heavy metals and CMR 1 & 2 or vPvB (very persistent and very bio-accumulative) or PBT (persistent, bio-accumulative and toxic) and is **REACH compliant**. It is 100% phthalate free and recyclable. Its VOC emissions after 28 days (ISO 16000-6) are below detection levels (<10 microgram/m<sup>3</sup>) and this product is classified A + (the best class). This flooring is **antistatic** (< 2 kV), its residual indentation is ≤ 0.02 mm to 150 minutes respecting EN ISO 24343-1. This flooring complies with EN ISO 10581 offering a Binder content Type I, which makes it suitable for heavy duty traffic areas. It has a **Bfl-s1 fire** resistance.

### Mipolam Accord

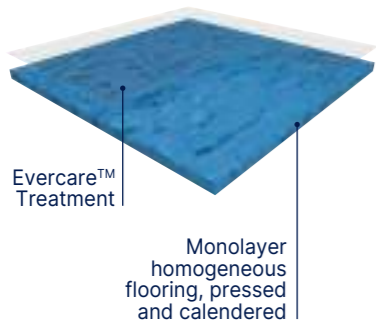

**MIPOLAM ACCORD** is a vinyl flooring homogeneous calendered and pressed in 2m sheets, with a thickness of 2 mm and a **weight of ≤ 2790 g**. The semi-directional design with colour throughout the thickness is available in 28 references presenting a nice **mat finish**. This flooring is recommended for collective buildings making skirtings easier, as well as angles and welding. The flooring is equipped with **Evercare™** the latest improvements in polyurethane surface treatment obtained by **UV laser cross-linking**. This Evercare™ **avoids staining of chemical products used in Healthcare** like Betadine, eosin or anti-bacterial hand gel and increases the durability of the flooring. This treatment has excellent maintenance characteristics and does not require the application of acrylic polishes. According to ISO 21702, **MIPOLAM ACCORD** has **anti-viral activity** against Human Coronaviruses: it reduces the number of virus by 99.7% after 2h. According to ISO 22196, **MIPOLAM ACCORD** has **anti-bacterial activity** against E. coli, S. aureus and MRSA of 99% after 24h. The flooring is composed of minimum **25% recycled content 100% controlled** and is **REACH compliant**. It is 100% phthalate free and 100% recyclable. This flooring is **antistatic** (<2kV). The product is non-reactive to residual indentation with a value ≤ 0.02 mm to 150 minutes respecting EN ISO 24343-1. The flooring is compliant with EN ISO 10581 norm, has a binder content type I, is suitable for heavy duty traffic areas and has a **Bfl-s1 fire** resistance. The product emission rate of volatile organic compounds is < 10 microgram/m<sup>3</sup> (TVOC after 28 days ISO 16000-6).

### Mipolam Troplan

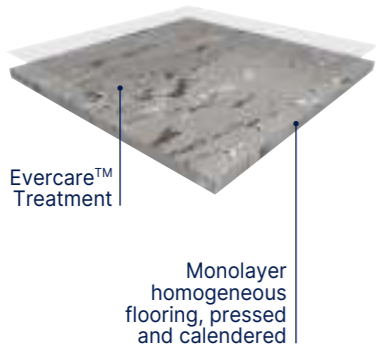

**MIPOLAM TROPLAN** is a vinyl flooring homogeneous calendered and pressed in 2 m sheets, with a thickness of 2 mm and a **weight ≤ 3300 g**. The directional design with colour throughout the thickness is available in 18 references presenting a nice **mat finish**. This flooring is suitable for medium to high traffic areas, and facilitates floor-wall junctions, angles and welding treatments. The flooring is equipped with **Evercare™**, patented surface treatment obtained by **UV laser cross-linking** offering **the best chemical resistance to the main products used in healthcare** environment as Betadine, eosin, hydro alcoholic solutions, making the maintenance easy and long lasting the flooring. This treatment **avoids applying any acrylic emulsion** throughout the lifetime of the product. According to ISO 21702, **MIPOLAM TROPLAN** has **anti-viral activity** against Human Coronaviruses: it reduces the number of virus by 99.7% after 2h. According to ISO 22196, **MIPOLAM TROPLAN** has **anti-bacterial activity** against E. coli, S. aureus and MRSA of 99% after 24h. It is composed of 45% minerals, 22% of inexhaustible material and at least **25% of recycled 100% controlled**. It is free of formaldehyde, heavy metals and CMR 1 & 2 or vPvB (very persistent and very bio-accumulative) or PBT (persistent, bio-accumulative and toxic) and is **REACH compliant**. **MIPOLAM TROPLAN** is 100% phthalate free and 100% recyclable. VOC emissions after 28 days (ISO 16000-6) are below detection levels with < 10 microgram/m<sup>3</sup> and this product is classified A + (the best class). The flooring is **antistatic** (< 2 kV), its residual indentation is ≤ 0.03 mm. The flooring is compliant to the EN ISO 10581 norm, has a binder content type II, is suitable for heavy duty traffic areas and has a **Bfl-s1 fire** resistance.



### High performing homogeneous multipurpose floorings

#### Suitable for heavy traffic areas (education, healthcare, shops)

► **Mipolam Affinity / Mipolam Accord / Mipolam Troplan:**  
**Evercare™ - New revolutionary patented polyurethane surface treatment with unique performance in staining providing unrivalled chemical and scratching resistance**

► **Antistatic**

► **Densely compacted surface for improved wear and ease of maintenance**

			Mipolam Affinity	Mipolam Accord	Mipolam Troplan
<b>Description</b>					
Total thickness	EN ISO 24346	mm	2	2	2
Weight	EN ISO 23997	g/sqm	2800	2790	3300
Width of sheet	EN ISO 24341	cm	200	200	200
Length of sheet	EN ISO 24341	lm	20	20	20
Tile size	EN ISO 24342	mm	608 × 608 <sup>(1)</sup>	608 × 608 <sup>(1)</sup>	608 × 608
Number of tiles per package	-	-	20	20	20
Phthalate free	-	-	OK	OK	OK
<b>Classification</b>					
Norm / Product specification	-	-	EN ISO 10581	EN ISO 10581	EN ISO 10581
European classification	EN ISO 10874	class	34-43	34-43	34-43
Fire rating	EN 13501-1	class	Bfl-s1	Bfl-s1	Bfl-s1
Static electrical propensity	EN 1815	kV	< 2	< 2	< 2
Slip resistance	EN 16165:2021 – Appendix B (DIN 51 130)	class	R9	R9	R9
<b>Performances</b>					
Type Binder content	EN ISO 10581	type	I	I	II
Dimensional stability (requirement)	EN ISO 23999	%	Sheet ≤ 0.40 Tile ≤ 0.25	Sheet ≤ 0.40 Tile ≤ 0.25	Sheet ≤ 0.40 Tile ≤ 0.25
Impact Sound Insulation	EN ISO 717-2	dB	5	5	4
Residual indentation (norm)	EN ISO 24343-1	mm	≤ 0.10	≤ 0.10	≤ 0.10
Residual indentation (average measured value)	-	mm	≈ 0.02	≈ 0.02	≈ 0.03
Castor chair test (type H)	ISO 4918	-	OK	OK	OK
Thermal conductivity	EN ISO 10456	W/(m.k)	0.25	0.25	0.25
Colour fastness	EN ISO 105-B02	degree	≥ 6	≥ 6	≥ 6
Surface treatment	-	-	Evercare™	Evercare™	Evercare™
Chemical products resistance	EN ISO 26987	class	OK	OK	OK
<b>Environment</b>					
Recycled content (average)	-	%	25	25	25
Recyclability	-	%	100	100	100
EPD	-	-	Available	Available	Available
<b>Health</b>					
TVOC after 28 days	ISO 16000-6	microgram/m <sup>3</sup>	< 10	< 10	< 10
Certification	-	-	Floorscore®	Floorscore®	Floorscore®
Anti-bacterial activity (E. coli - S. aureus - MRSA) after 24h <sup>(2)</sup>	ISO 22196	-	> 99% inhibits growth	> 99% inhibits growth	> 99% inhibits growth
Anti-viral activity (human coronavirus) after 2h <sup>(2)</sup>	ISO 21702	-	> 99.7% virucidal activity	> 99.7% virucidal activity	> 99.7% virucidal activity
<b>CE Marking</b>					
			EN 14041		

(1) Products available in tiles for a minimum order quantity of 500 sqm.

(2) The implementation of an effective cleaning regime is the most important defence against infection.

# Mipolam Homogeneous Evercare™

Mipolam Affinity

 Compact  
 Compact  
 608 x 608 mm

Evercare™

 100% recyclable

  
 Matt finish



4476 Amethyst



^ Scale 1



4476 Amethyst - 4402 Yuki

 ▶ MCR40<sup>(1)</sup>  
 ▶ CR40<sup>(2)</sup>

 4417 Aquamarine  	 4408 Crystal Ice  	 4482 Orchid  	 4448 Ruby  
 4496 Light Sapphire  	 4409 Matte Grey  	 4481 Rosaspina  	 4475 Cinabre  
 4416 Sapphire  	 4410 Violet Grey  	 4437 Cashmere Rose  	 4455 Orange Sunlight  
 4446 Blue Ocean  	 4426 Baltic  	 4429 Gray Opal  	 4435 Butternut  
 4436 Santorini  	 4420 Silver Grey  	 4430 Pearl Grey  	 4425 Amber  
 4466 Thistle  	 4450 Stormy Weather  	 4434 Cast Iron  	
 4460 Black Stone  	 4459 Grey Storm  	 4433 Ash Coat  	

(1)  Mentioned colors available with MCR40 specific multicolor welding rod (code: H058)

(2) All colors available with CR40 matching uni welding rod (code: 0585)

# Mipolam Homogeneous Evercare™

Mipolam Affinity

 Compact  
 Compact  
 608 x 608 mm  
 Evercare™  
 100% recyclable

  
 Matt finish

 ▶ MCR40<sup>(1)</sup>  
 ▶ CR40<sup>(2)</sup>



4402 Yuki  
 

^ Scale 1



4402 Yuki - 4447 Light Emerald



(1)  Mentioned colors available with MCR40 specific multicolor welding rod (code: H058)  
 (2) All colors available with CR40 matching uni welding rod (code: 0585)

# Mipolam Homogeneous Evercare™

## Mipolam Accord

 Compact  
 Compact  
 608 × 608 mm  
 Evercare™  
 100% recyclable

  
 Matt finish

  
 ▶ MCR40<sup>(1)</sup>  
 ▶ CR40<sup>(2)</sup>





0330 Kruger  

^ Scale 1



0330 Kruger / 0321 Salt

 0321 Salt  	 0301 Louise  	 0305 Light Sand  	 0332 Dore  
 0312 Powell  	 0303 Manitoba  	 0324 Sand  	 0447 Grunsee  
 0310 Huron  	 0319 Toba  	 0441 Loch Ness  	 0315 Orange River  
 0306 Inari  	 0320 Ontario  	 0463 Bourget  	
 0316 Malaren  	 0450 Thames  	 0443 Krumme  	
 0346 Roxen  	 0360 Balaton  	 0459 Mississippi  	

# Mipolam Homogeneous Evercare™

Mipolam Troplan



Mipolam  
Homogeneous



1004 Earth



1004 Earth

^ Scale 1



1032 Yellow



1055 Apricot

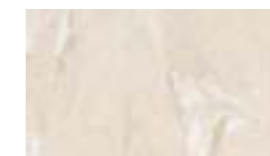

1002 Beige



1009 Light Grey



1006 Blue



1007 Green



1003 Light Ocre



1010 Grey



1036 Medium Blue



1037 Medium Green



1035 Ocre



1059 Blue Grey



1056 Dark Blue



1057 Dark Green



1033 Brown



1040 Dark Grey



1060 Anthracite



# Mipolam Homogeneous Easycare

Mipolam Astro **New**

Mipolam Astro



**MIPOLAM ASTRO** is a vinyl flooring homogeneous **pressed** in 2m sheets, with a thickness of 2mm and a **weight of 2900 g**. The Non-directional design with colour throughout the thickness is available in 14 references presenting a nice **matt finish**. This flooring is suitable for medium to high traffic areas, and facilitates floor-wall junctions, angles and welding treatments. The flooring is equipped with **Easycare** offering **chemical resistance to the main products used in healthcare** environment as Betadine, eosin, hydro alcoholic solutions, making the maintenance easy and long lasting the flooring. This treatment **avoids applying any acrylic emulsion** throughout the lifetime of the product. It is composed of 74% sustainable raw materials, and **25% of recycled content**. It is free of formaldehyde, heavy metals and CMR 1 & 2 or vPvB (very persistent and very bio accumulative) or PBT (persistent, bio-accumulative and toxic) and is **REACH compliant**. It is 100% phthalates free and 100% recyclable. According to ISO 21702, **MIPOLAM ASTRO** has **anti viral activity** against Human Coronaviruses: it reduces the number of virus by 99,7% after 2h00. According to ISO 22196, **Mipolam Astro** has **anti bacterial activity** against E. coli, S. aureus and MRSA of 99% after 24h00. COV emissions after 28 days (ISO 16000-6) are below detection levels with <10 µg / m<sup>3</sup> and this product is classified A + (the best class). The flooring is **antistatic** (<2kV), its residual indentation is ≤ 0.02 mm. The flooring is compliant with EN ISO 10581 norm, has a binder content type I, is suitable for heavy duty traffic areas and has **Bfl-s1** fire resistance.



Easycare



100% recyclable

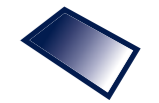

Matt finish

- ▶ **Non directional design**
- ▶ **Perfect finishing**
  - Color matching welding rods
  - Coordinated with Gerflor wall coverings
- ▶ **Heavy traffic resistance**

- ▶ **Easy maintenance**
  - Easycare surface treatment
  - Recommended with Gerflor Clean Corner System and entrance mats

Mipolam Astro

Description			
Total thickness	EN ISO 24346	mm	2
Weight	EN ISO 23997	g/sqm	2900
Width of sheet	EN ISO 24341	cm	200
Length of sheet	EN ISO 24341	lm	20
Phthalate free	-	-	OK
Classification			
Norm / Product specification	-	-	EN ISO 10581
European classification	EN ISO 10874	class	34-43
Fire rating	EN 13501-1	class	Bfl-s1
Static electrical propensity	EN 1815	kV	≤ 2
Slip resistance	EN 16165:2021 – Appendix B (DIN 51 130)	class	R9
Performances			
Type Binder content	EN ISO 10581	type	I
Dimensional stability	EN ISO 23999	%	≤ 0.40
Impact Sound Insulation	EN ISO 717-2	dB	5
Residual indentation (norm)	EN ISO 24343-1	mm	< 0.10
Residual indentation (average measured value)	-	mm	≈ 0.02
Castor chair test (type H)	ISO 4918	-	OK
Thermal conductivity	EN ISO 10456	W/(m.k)	0.25
Colour fastness	EN ISO 105-B02	degree	≥ 7
Surface treatment	-	-	Easycare
Chemical products resistance	EN ISO 26987	class	OK
Environment			
Recycled content (average)	-	%	25
Recyclability	-	%	100
EPD	-	-	Available
Health			
TVOC after 28 days	ISO 16000-6	microgram/m <sup>3</sup>	< 10
Certification	-	-	Floorscore®
Anti-bacterial activity (E. coli - S. aureus - MRSA) after 24h <sup>(1)</sup>	ISO 22196	-	> 99% inhibits growth
Anti-viral activity (human coronavirus 229E) after 2h <sup>(1)</sup>	ISO 21702	-	> 99.7% virucidal activity

**CE Marking**



EN 14041



(1) The implementation of an effective cleaning regime is the most important defence against infection.

# Mipolam Homogeneous Easycare

Mipolam Astro **New**



Compact  
608 x 608 mm

Easycare



100% recyclable



Matt finish

Mipolam  
Homogeneous



2496 Skiff / 2430 Panstarrs

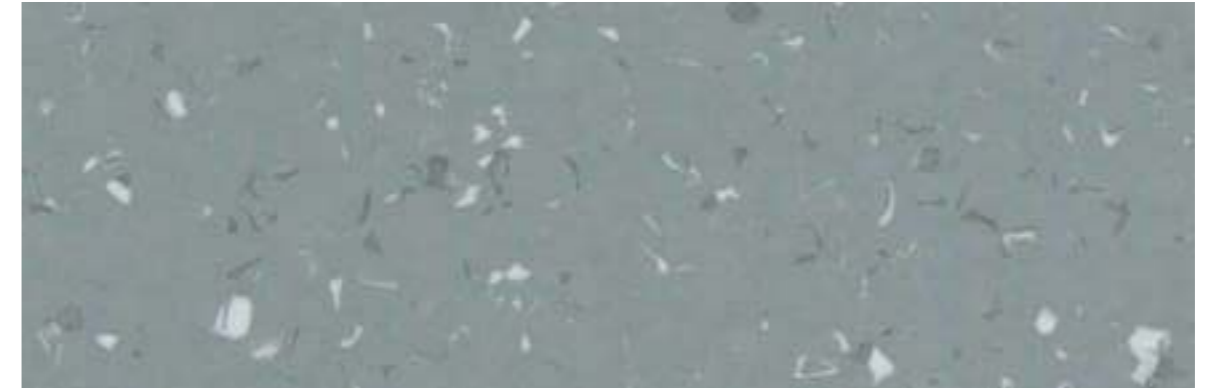

2430 Panstarrs

^ Scale 1



2410 Tempel



2408 Halley

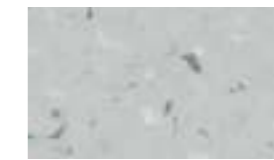

2411 Catalina



2401 Wise



2496 Skiff



2409 Soho



2441 Helin



2424 Biela



2446 Spacewatch



2413 Cineos



2463 Linear



2432 Lemmon



2425 Neat



# Mipolam Homogeneous PUR

## Mipolam Classic

### Mipolam Classic

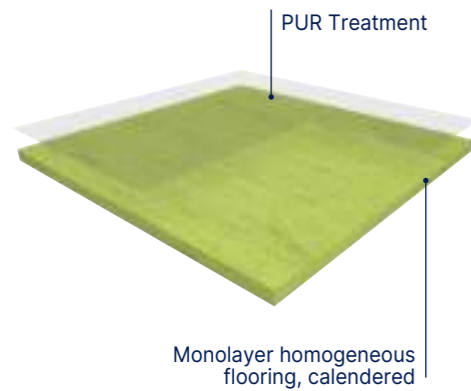

**MIPOLAM CLASSIC 1.5 mm** is a flexible homogeneous calendered compacted floorcovering in tiles or sheets, with directional design, colour dyed as a raw mixture to ensure even colour throughout the thickness of 1.5 mm and a **weight of  $\leq 2520$  g**. Its surface is densely compacted for improved wear and ease of maintenance. It receives a polyurethane (**PUR**) surface treatment for ease of maintenance and to avoid the use of an immediate acrylic emulsion after installation. The flooring complies with the **EN ISO 10874** (34-43) and EN ISO 10581, has a binder content type II, has Bfl-s1 fire resistance. It is suitable for heavy traffic areas. It is 100% recyclable. Its VOC emissions after 28 days (ISO 16000-6) are below detection levels ( $< 10$  microgram/m<sup>3</sup>) and this product is classified A + (the best class).

**MIPOLAM CLASSIC 2 mm** is a flexible homogeneous calendered compacted floorcovering in tiles or in 2 m sheets, with a thickness of 2 mm and a **weight of  $\leq 3300$  g**. This directional design, colour dyed as a raw mixture to ensure even colour throughout the thickness is available in 14 references. Its surface is densely compacted for improved wear and ease of maintenance. It receives a polyurethane (**PUR**) surface treatment for ease of maintenance and to avoid the use of an immediate acrylic emulsion after installation. The flooring complies with the **EN ISO 10874** (34-43) and EN ISO 10581, has a binder content type II, has Bfl-s1 fire resistance. It is suitable for heavy traffic areas. It is 100% recyclable. Its VOC emissions after 28 days (ISO 16000-6) are below detection levels ( $< 10$  microgram/m<sup>3</sup>) and this product is classified A + (the best class).

#### Mipolam Classic

Description				
Total thickness	EN ISO 24346	mm	1.5	2
Weight	EN ISO 23997	g/sqm	2520	3300
Width of sheet	EN ISO 24341	cm	200	200
Length of sheet	EN ISO 24341	lm	20	20
Tile size	EN ISO 24342	mm	-	300 × 300 <sup>(1)</sup> / 608 × 608
Number of tiles per package	-	-	-	50 / 20
Classification				
Norm / Product specification	-	-	EN ISO 10581	EN ISO 10581
European classification	EN ISO 10874	class	23-31	34-43
Fire rating	EN 13501-1	class	Bfl-s1	Bfl-s1
Static electrical propensity	EN 1815	kV	< 2	< 2
Performances				
Type Binder content	EN ISO 10581	type	II	II
Dimensional stability	EN ISO 23999	%	$\leq 0.40$	Sheet $\leq 0.40$ / Tile $\leq 0.25$
Impact Sound Insulation	EN ISO 717-2	dB	-	4
Residual indentation (norm)	EN ISO 24343-1	mm	$\leq 0.10$	$\leq 0.10$
Residual indentation (average measured value)	-	mm	$\approx 0.03$	$\approx 0.03$
Castor chair test (type H)	ISO 4918	-	OK	OK
Thermal conductivity	EN ISO 10456	W/(m.k)	0.25	0.25
Colour fastness	EN ISO 105-B02	degree	$\geq 6$	$\geq 6$
Surface treatment	-	-	PUR	PUR
Chemical products resistance	EN ISO 26987	class	OK	OK
Environment				
Recycled content (average)	-	%	25	25
Recyclability	-	%	100	100
EPD	-	-	Available	Available
Health				
TVOC after 28 days	ISO 16000-6	microgram/m <sup>3</sup>	< 10	< 10
Certification	-	-	Floorscore®	Floorscore®
CE Marking				



EN 14041



(1) Tiles (300 × 300 mm) available for a minimum order quantity of 500 sqm.



0002 Platinum

▲ Scale 1



0108 Pepper



0122 Pineapple



0123 Corallo

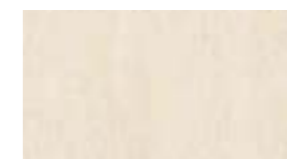

0301 Beige



0005 Steel



0010 Azure

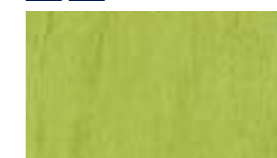

0121 Green Leaf



0003 Ivory



0303 Grey



0013 Pewter



0124 Tortora

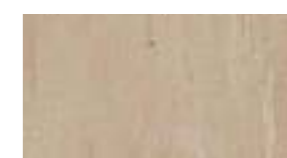

0014 Brown



0125 Truffle



All colours available as 300 × 300mm tiles upon request for a minimum order quantity of 500 sqm.  
▲ Thickness: 1.5 mm - Sheet format only



# Taralay Multilayered

pages 52-343

- 56. Taralay Millenium
- 60. Taralay Libertex **New**
- 66. Taralay Impression  
Taralay Impression **hop**
- 92. My Taralay Impression
- 96. Taralay Initial **New**

# Taralay Multilayered

**Premium**  
See pages 8/23

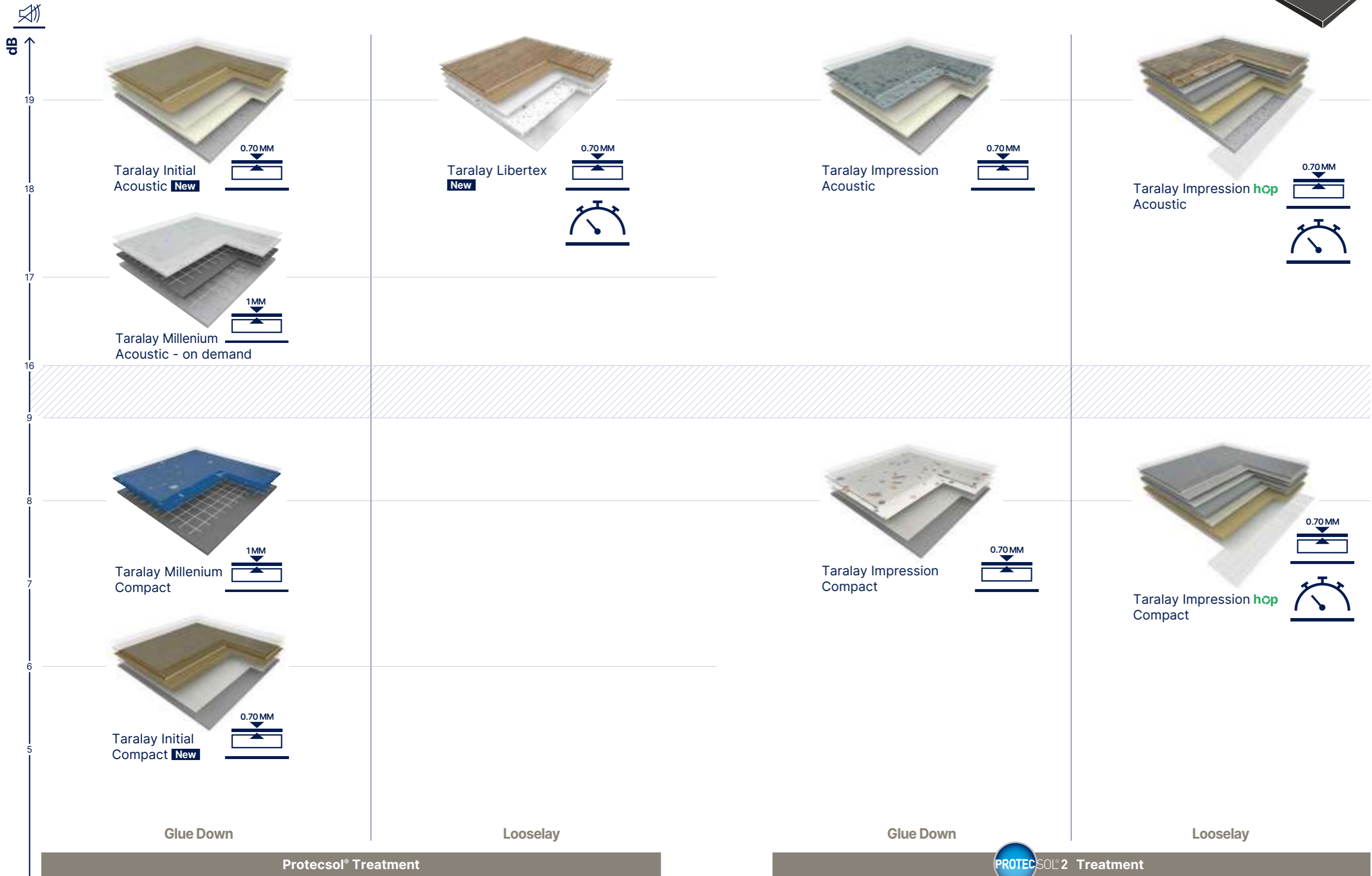

Taralay Multilayered

— Maintenance —+

# Taralay Multilayered

## Taralay Millenium

### Taralay Millenium Compact

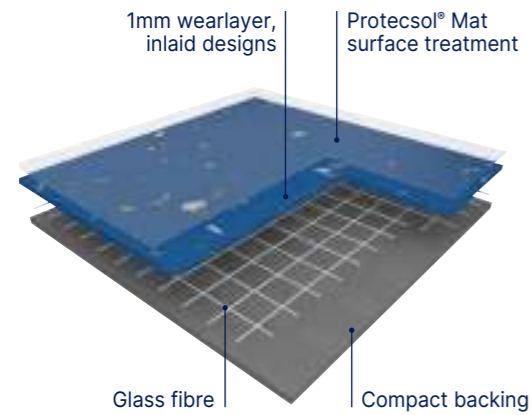

**TARALAY MILLENIUM COMPACT** is a multilayered vinyl floor covering available in 2m wide sheet, with a group T wear rating. The product comprises a **1 mm thick coated wear layer, made of pure vinyl, coloured throughout its thickness (no transparent wear layer and no filler)**. Its complete thickness is 2 mm. It is reinforced with a fibre glass grid for a better dimensional stability. The construction of the product yields a 8dB sound insulation rating and a **resistance to indentation of 0.03 mm**.

This flooring is protected by the surface treatment, **Protecso! Mat**, with a minimum thickness of 13µm, ensuring easy maintenance and no required polish for the entire lifetime of the product.

It is composed of 50% mineral and inexhaustible materials. It does not contain any heavy metals or CMR 1&2 components and it is 100% compliant with REACH. The product emission rate of volatile organic compounds is <10 micrograms/m<sup>3</sup> (TVOC after 28 days ISO 16000-6).

It is 100% recyclable.

### Taralay Millenium Acoustic (on demand)

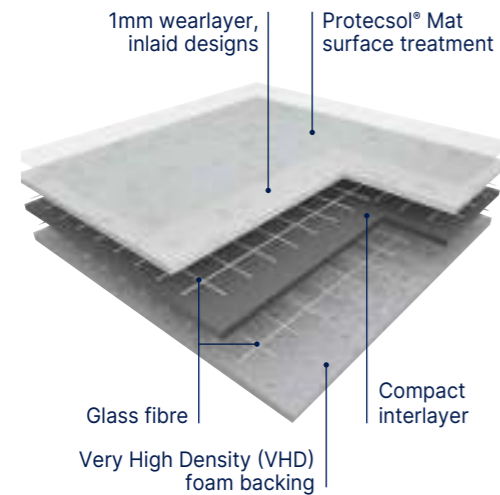

**TARALAY MILLENIUM ACOUSTIC** is a multilayered vinyl floorcovering available in 2m wide sheet, with a group T wear rating. The product comprises a **1 mm thick coated wear layer, made of pure vinyl, coloured throughout its thickness (no transparent wear layer and no filler)**. Its complete thickness is 3.4 mm. It contains a Very High Density (VHD) foam backing and is reinforced with 2 fibre glass grids which yields a **17dB sound insulation** rating and a **resistance to indentation of 0.07 mm**.

This flooring is protected by the surface treatment, **Protecso! Mat**, with a minimum thickness of 13µm, ensuring easy maintenance and no required polish for the entire lifetime of the product.

It is composed of 50% mineral and inexhaustible materials. It does not contain any heavy metals or CMR 1&2 components and it is 100% compliant with REACH. The product emission rate of volatile organic compounds is <10 micrograms/m<sup>3</sup> (TVOC after 28 days ISO 16000-6).

It is 100% recyclable.



- **Design within the whole thickness – no filler**  
Outstanding abrasion resistance
- **Very high density (VHD) foam backing**  
Easy rolling for loads
- **Protecso! Mat Surface Treatment**  
Easy cleaning
- **100 % Recyclable**  
Eco-responsible solutions

Description			Taralay Millenium Compact	Taralay Millenium Acoustic*
	Total thickness	EN ISO 24346	mm	2.00
Thickness of wearlayer	EN ISO 24340	mm	1	1
Weight	EN ISO 23997	g/sqm	2725	3385
Width of sheet	EN ISO 24341	cm	200	200
Length of sheet	EN ISO 24341	lm	20	25
<b>Classification</b>				
Norm / Product specification	-	-	EN ISO 10582	ISO 11638 (EN 651)
European classification	EN ISO 10874	class	34-43	34-42
Fire rating	EN 13501-1	class	Bfl-s1	Cfl-s1
Static electrical propensity	EN 1815	kV	< 2	< 2
Slip resistance wet	EN 16165:2021 – Appendix B (DIN 51 130)	class	R10	R10
<b>Performances</b>				
Wear resistance	EN 660.2	mm <sup>3</sup>	≤ 2.0	≤ 2.0
Wear group	-	group	T	T
Type Binder content	EN ISO 10582	type	I	-
Dimensional stability	EN ISO 23999	%	≤ 0.40	≤ 0.40
Residual indentation (requirement)	EN ISO 24343-1	mm	≤ 0.10	≤ 0.20
Residual indentation (average measured value)	-	mm	≈ 0.03	0,07
Impact sound insulation	EN ISO 717-2	dB	8	17
Castor chair test (type H)	ISO 4918	-	OK	OK
Thermal conductivity	EN ISO 10456	W/(m.k)	0.25	0.25
Colour fastness	EN ISO 105-B02	degree	≥ 6	≥ 6
Surface treatment	-	-	Protecso! Mat	Protecso! Mat
Chemical products resistance	EN ISO 26987	-	OK	OK
<b>Environment</b>				
Recyclability	-	%	100	100
<b>Health</b>				
TVOC after 28 days	ISO 16000-6	microgram/m <sup>3</sup>	< 10	< 10
Certification	-	-	Floorscore®	Floorscore®
Anti-bacterial activity (E. coli - S. aureus - MRSA) <sup>(1)</sup>	ISO 22196	-	> 99% inhibits growth	> 99% inhibits growth
Anti-viral activity (human coronavirus) after 2h <sup>(1)</sup>	ISO 21702	-	> 99.3% virucidal activity	> 99.3% virucidal activity
<b>CE marking</b>				



(1) The implementation of an effective cleaning regime is the most important defence against infection.  
\*available on demand (minimum order quantity: 1000 sqm)

# Taralay Multilayered

## Taralay Millenium - Cosmic



 17 dB
 
 Protacosol® Mat
 
 100% recyclable

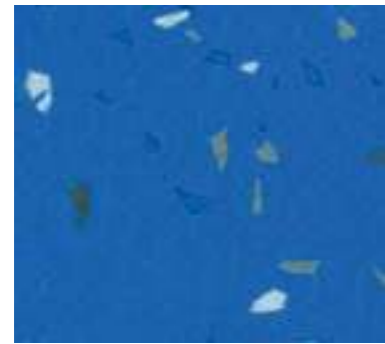

5718 Pallas 



5718 Pallas



8856 Pandore 



5728 Ilias 



5723 Lotis 



5721 Fortuna 



3442 Doris 



3438 Iris 



4162 Adonis 



4038 Delia 



4369 Egeria 



4036 Vesta 



4368 Astree 



4037 Gyptis 



4533 Ceres 



3435 Nemesis 



4161 Hilda 



4160 Hermione 



4159 Kalliope 



8645 Bianca 



4374 Aria 



4532 Sylvia 



4531 Camilla 

## Taralay Millenium - Stellar



 17 dB
 
 Protacosol® Mat
 
 100% recyclable



4163 Flore



4163 Flore 



3446 Eden 

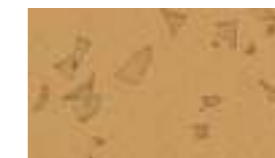

4039 Pan 

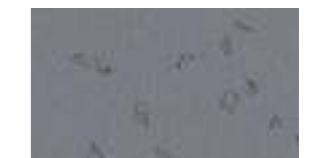

5724 Chicago 



4200 Apolon 



4373 Fudo 



4372 Boree 



4164 Eros 



3439 Europa 



5726 Yuna 



5725 Freia 

\*Acoustic: available on demand (minimum order quantity: 1000 sqm)

\*Acoustic: available on demand (minimum order quantity: 1000 sqm)

# Taralay Multilayered - fast track installation

Taralay Libertex **New**



34

**High traffic resistance**  
0.7mm wearlayer



19 dB

**Comfort**  
Max<sup>3</sup> Layer system



**Circular Economy**  
100% recyclable product



**Indoor Air Quality**  
Adhesive Free installation means virtually no VOC!

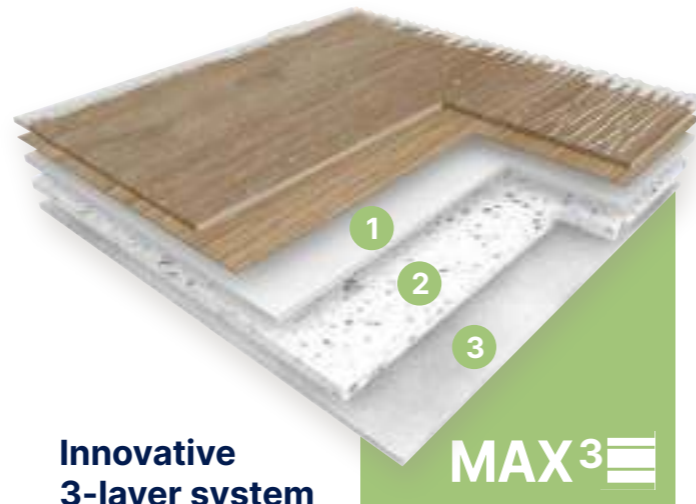

## Innovative 3-layer system

- 1 High density foam complexed with fiber glass
- 2 Acoustic foam layer
- 3 Reinforced textile backing

**MAX<sup>3</sup>**



19 dB

Protocolsol®



100% recyclable



**Textile Backing**

## Valencay



1442 Valencay Pecan



16 x 100 cm



0368 Valencay Blond



16 x 100 cm



0179 Valencay Patine



16 x 100 cm

## Pure Oak



1751 Pure Oak Grey



16 x 100 cm



0720 Pure Oak Clear



16 x 100 cm

## Habana



0797 Habana Ivory



20 x 133.3 cm



0828 Habana Beige



20 x 133.3 cm

## Azay Cream

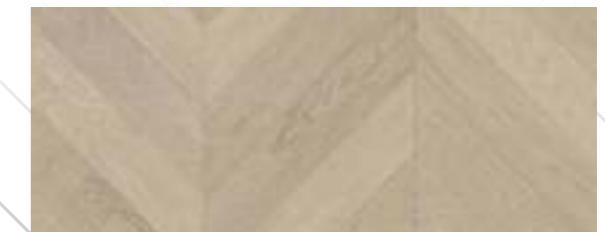

2346 Azay Cream



10 x 35 cm

## Fast track renovation



**No shutdown**  
No odor, no glue, minimum facility downtime



**Renovation**  
on existing subfloor

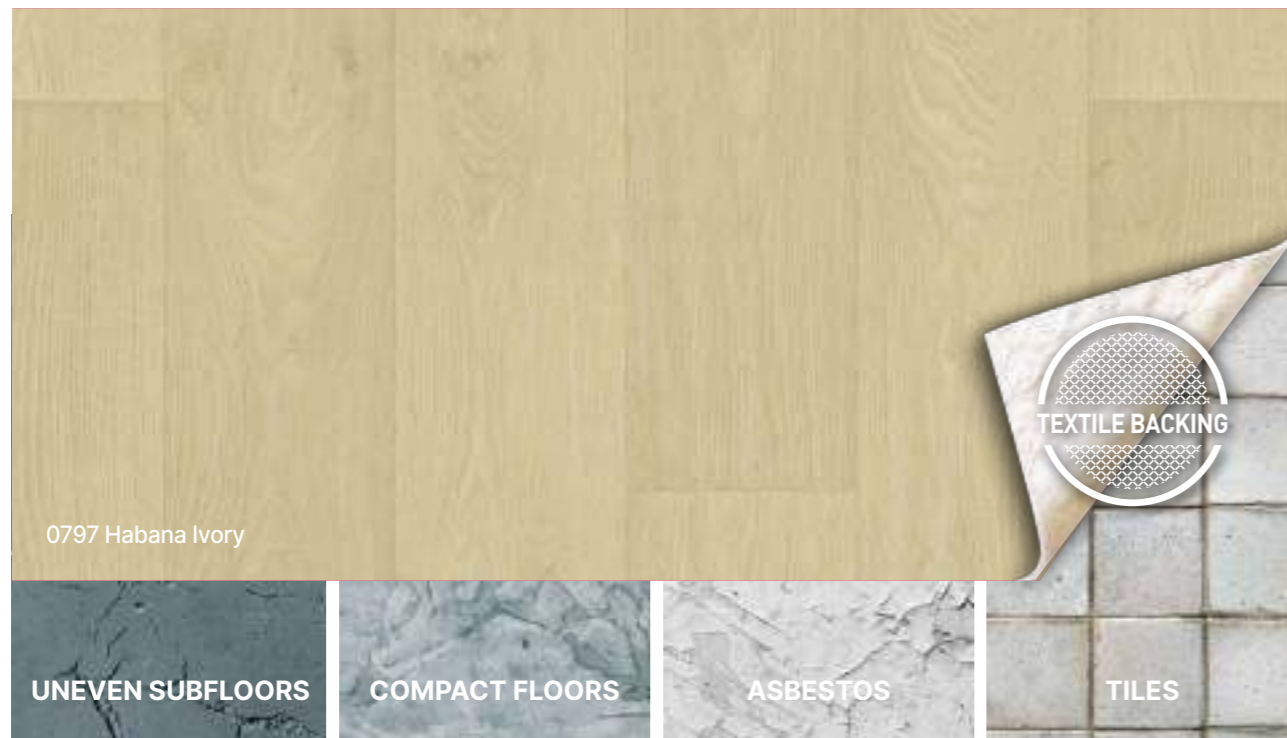

2346 Azay Cream

# Taralay Multilayered - fast track installation

Taralay Libertex **New**



19 dB

Protocolsol®



100% recyclable



Textile Backing



2226 Cordoba Black & White / 2413 Cottage Blond

## Cottage



2415 Cottage Clear

20 × 133,3 cm



2413 Cottage Blond

20 × 133,3 cm



2426 Cottage Brown

20 × 133,3 cm

## Esterel Blond

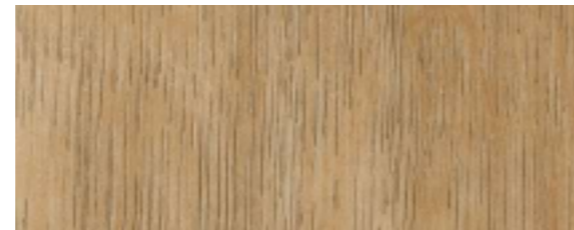

0636 Esterel Blond

10 × 100 cm

## Cordoba Black & White



2226 Cordoba Black & White

25 × 25 cm



2284 Chicago Storm

## Chicago



2460 Chicago Cream

^ Scale 1

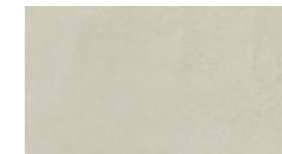

2459 Chicago Haze



2366 Chicago Sand

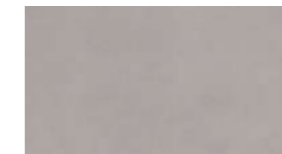

2284 Chicago Storm

## Rough



2225 Rough Light Grey

^ Scale 1



2218 Rough Taupe



2219 Rough Chocolate

# Taralay Multilayered - fast track installation

## Taralay Libertex New

### Taralay Libertex

**TARALAY LIBERTEX** is ideal for fast track installation or renovations in commercial buildings. It is a multi-layered vinyl floorcovering with a printed design protected by a 0.70 mm thick transparent wear layer. The product features a high density foam complexed with fiber glass, an acoustic foam layer and a reinforced textile backing. It offers **19 dB sound insulation**.

It is available in 2 m and 4 m wide sheet, offers a R10 slip resistance and a group T wear rating. It is mechanically embossed, benefits from **Protectsol®** surface treatment and has an ultra matt look.

**TARALAY LIBERTEX** is a worry-free looselay solution. It is laid without glue, simply applying a double-sided tape such as Fix&Free on room edge and at the joint. Its textile backing absorbs surface irregularities requiring minimal subfloor preparation on uneven floors. It is compatible with cold welding, hot welding, coving, and Vynaflex skirtings.

It includes at least 30% mineral materials and 20% renewable materials. Textile backing is made at 95% from recycled PET bottles. It is 100% recyclable and 100% REACH compliant. Its VOC emissions after 28 days (ISO 16000) are below 100 microgram/m<sup>3</sup>. It is classified A + (the best class) for indoor air quality.

### Fast installation in one solution!



#### Adhesive free

Apply double-sided tape (such as Fix&Free 100 Ref. 058U) on welding area and on room edges



#### Hot welding

for 100% watertight hygienic system (Ref. CR40 0585)



#### Cold welding

for invisible joint (see Romus #95605)



#### Wall transition

- Vynaflex skirtings, ideal for commercial applications (H 60 mm - Ref. 0483 / H 80 mm - Ref. 0482 / H 100 mm - Ref. 0477)
- Coving for 100% watertight hygienic system



#### Entrance Mats

A new quick & easy installation of entrance mats with KIT ESPLANADE 9000 (Ref. 1700) or ROMAT GT (Ref. 1719)



More information on [gerflor.com](http://gerflor.com)



19 dB

Protectsol®



100% recyclable

### Fast track installation

- Minimal subfloor preparation: textile backing absorbs subfloor irregularities
- No shutdown, no odor, ideal for occupied rooms thanks to looselay installation
- No drying time, no glue

**Hygienic and easy maintenance:** Protectsol® surface treatment

**Comfort:** 19 dB sound reduction

Libertex			
Description			
Total thickness	EN ISO 24346	mm	3.65
Thickness of wearlayer	EN ISO 24340	mm	0.70
Weight	EN ISO 23997	g/sqm	2900
Width of sheet	EN ISO 24341	cm	200/400
Length of sheet	EN ISO 24341	lm	20
Phthalate free	-	-	OK
Classification			
Norm / Product specification	-	-	EN ISO 11638
European classification	EN ISO 10874	class	34-43
Fire rating	EN 13501-1	class	Cfl-s1
Static electrical propensity	EN 1815	kV	< 2
Slip resistance wet	EN 16165:2021 – Appendix B (DIN 51 130)	class	R10
Performances			
Wear resistance	EN 660.2	mm <sup>3</sup>	≤ 2.0
Wear group	-	group	T
Dimensional stability (requirement)	EN ISO 23999	%	≤ 0.40
Dimensional stability (measured value)	-	-	≤ 0.05
Residual indentation (requirement)	EN ISO 24343-1	mm	≤ 0.20
Impact sound insulation	EN ISO 717-2	dB	19
Room impact	NF S 31 074	dB	< 65
Thermal conductivity	EN ISO 10456	W/(m.k)	0.25
Colour fastness	EN ISO 105-B02	degree	≥ 6
Surface treatment	-	-	Protectsol®
Chemical products resistance <sup>(1)</sup>	EN ISO 26987	-	OK
Environment			
Recyclability	-	%	100
EPD	-	-	Available
Health			
TVOC after 28 days	ISO 16000-6	microgram/m <sup>3</sup>	< 100
CE marking			



EN 14041



(1) Regarding the resistance to chemicals, please download the corresponding leaflet from our website.

# Taralay Multilayered

## Taralay Impression

### Taralay Impression Compact

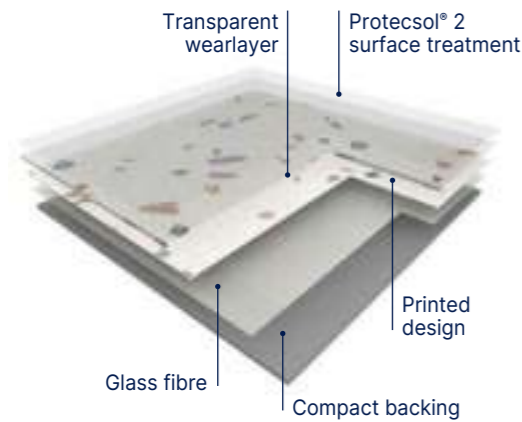

**TARALAY IMPRESSION COMPACT 0,7** is a multi-layered vinyl floorcovering, integrating a fiber glass and a printed design. It's available in 2 m wide sheet, with a group T wear rating. Total width of the product is 2 mm, including a transparent wear layer of 0.70 mm thick. **It offers 8 dB sound insulation and an indentation resistance of ca. 0.03 mm.** Its **dimensional stability** performs down to 0,08% (average measure). **TARALAY IMPRESSION COMPACT** is made in France. It's **100% recyclable**, and the floorcovering will have its individual EPD sheet. The flooring is equipped with **Protecsol® 2**, patented surface treatment obtained by UV laser cross-linking offering the best chemical resistance to the main products used in healthcare environment as betadine, eosin, hydro alcoholic solutions, making the maintenance easy and the floor long lasting. This treatment avoids applying any acrylic emulsion throughout the lifetime of the product. It is **free of formaldehyde, heavy metals and CMR 1 & 2 or vPvB** (very persistent and very bio accumulative) or PBT (persistent, bio-accumulative and toxic) and is 100% REACH compliant. Its VOC emissions after 28 days (ISO 16000-6) are below detection levels (<10 µg / m<sup>3</sup>) and this product is classified A + (the best class) and Floorscore® & M1 certified for indoor air quality. Taralay Impression Compact has antibacterial efficacy (E.coli / S.aureus / MRSA): >99% after 24 hours according to ISO22196.

### Taralay Impression Acoustic

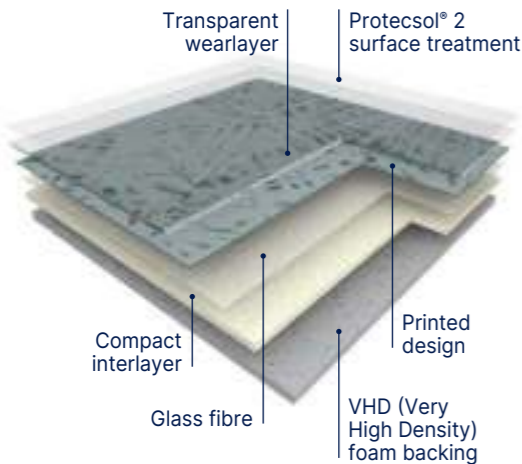

**TARALAY IMPRESSION ACOUSTIC 0,65** is a multi-layered vinyl floorcovering, integrating a **Very High Density foam backing**, reinforced with a fiber glass and a printed design. It's available in 2 m wide sheet, with a group T wear rating. Total width of the product is **3,35 mm**, including a transparent wear layer of 0.65 mm thick. It offers **19 dB sound insulation and an indentation resistance of ca. 0.08 mm.** Its **dimensional stability** performs down to **0,08%** (average measure). **TARALAY IMPRESSION ACOUSTIC** is made in France, with green electricity. It's **100% recyclable**, and the floorcovering will have its individual EPD sheet. The flooring is equipped with **Protecsol® 2**, patented surface treatment obtained by UV laser cross-linking offering the best chemical resistance to the main products used in healthcare environment as betadine, eosin, hydro alcoholic solutions, making the maintenance easy and the floor long lasting. This treatment avoids applying any acrylic emulsion throughout the lifetime of the product. It is **free of formaldehyde, heavy metals and CMR 1 & 2 or vPvB** (very persistent and very bio accumulative) or PBT (persistent, bio-accumulative and toxic) and is 100% REACH compliant. Its VOC emissions after 28 days (ISO 16000-6) are below detection levels (<10 µg / m<sup>3</sup>) and this product is classified A + (the best class) and Floorscore® & M1 certified for indoor air quality. Taralay Impression Compact has antibacterial efficacy (E.coli / S.aureus / MRSA): >99% after 24 hours according to ISO22196.



- **Ultra-realistic designs:**  
Realistic embosses and plank dimensions for wood designs
- **Matt effect**
- **Extreme stain resistance, easy maintenance:**  
Protecsol® 2 surface treatment (patented technology by Gerflor)
- **High traffic resistance, long-lasting appearance**  
Available with a 0.7 mm wearlayer and available with a 0.9 mm wearlayer upon request (minimum order quantity of 800 sqm)
- **The best acoustic / indentation performance on the market**  
COMPACT: 0.03 mm / 8 dB  
ACOUSTIC: 0.08 mm / 19 dB
- **Eco-responsible solution**  
Best in class for indoor air quality (TVOC < 10 microgram/m<sup>3</sup> after 28 days)

Description			Taralay Impression Compact	Taralay Impression Acoustic
Total thickness	EN ISO 24346	mm	2.00	3.35
Wearlayer Thickness	EN ISO 24340	mm	0.70	0.65
Weight	EN ISO 23997	g/sqm	2635	2825
Width of sheet	EN ISO 24341	cm	200	200
Length of sheet	EN ISO 24341	lm	25	25
Phthalate free	-	-	OK	OK
<b>Classification</b>				
Norm / Product specification	-	-	EN ISO 10582	EN ISO 11638
European classification	EN ISO 10874	class	34-43	34-42
Fire rating	EN 13501-1	class	Bfl-s1	Bfl-s1
Static electrical propensity	EN 1815	kV	< 2	< 2
Slip resistance	EN 16165:2021 – Appendix B (DIN 51 130)	class	R10	R10
<b>Performances</b>				
Wear resistance	EN 660.2	mm <sup>3</sup>	≤ 2.0	≤ 2.0
Wear group	-	group	T	T
Type Binder content	EN ISO 10582	type	I	-
Dimensional stability (requirement)	EN ISO 23999	%	≤ 0.40	≤ 0.40
Dimensional stability (measured value)	-	%	0,08	0,08
Residual indentation (requirement)	EN ISO 24343-1	mm	≤ 0.10	≤ 0.20
Residual indentation (average measured value)	-	mm	≈ 0.03	≈ 0.08
Impact sound insulation	EN ISO 717-2	dB	8	19
Castor chair test (type H)	ISO 4918	-	OK	OK
Thermal conductivity	EN ISO 10456	W/(m.k)	0.25	0.25
Colour fastness	EN ISO 105-B02	degree	≥ 6	≥ 6
Surface treatment	-	-	PROTECSOL® 2	PROTECSOL® 2
Chemical products resistance <sup>(1)</sup>	EN ISO 26987	-	OK	OK
<b>Environment</b>				
Recycled content (average)	-	%	14	17
Recyclability	-	%	100	100
EPD	-	-	Available	Available
<b>Health</b>				
TVOC after 28 days	ISO 16000-6	microgram/m <sup>3</sup>	< 10	< 10
Certification	-	-	Floorscore®	Floorscore®
Anti-bacterial activity (E. coli - S. aureus - MRSA) after 24h <sup>(2)</sup>	ISO 22196	-	> 99% inhibits growth	> 99% inhibits growth
Anti-viral activity (human coronavirus) after 2h <sup>(2)</sup>	ISO 21702	-	> 99.7% virucidal activity	> 99.7% virucidal activity
<b>CE Marking</b>				



EN 14041



(1) Regarding the resistance to chemicals, please download the corresponding leaflet from our website.  
(2) The implementation of an effective cleaning regime is the most important defence against infection.

# Taralay Multilayered

Taralay Impression **hop**: the looselay solution



## Eco-design valued at each stage of the life cycle

### GERFLOR COMMITTED

to communicating transparently about the carbon impact of its products and focusing on eco-design, including the use of sustainable raw materials, the sustainability of its products and circular economy

### 1- Raw materials

**+ 23%** Recycled content

TVOC < 10 micrograms/m<sup>3</sup>

Reach compliant\*

### 4- A second life made easier

**100% RECYCLABLE** 100% recyclable

Uninstall and re-use:  
 • Flooring can be uninstalled without damaging either the product or the surface underneath  
 • Flooring can be re-used for another building

Easy to recycle  
 • Qualifies for the **the Second Life Programme**  
 • Flooring is incorporated back into our production lines

**FLOOR TO FLOOR** A unique partnership with Paprec, recycling programmes that are certified by Europlast



Accelerating recycling is essential for building a more circular economy. Preserving resources and reducing the carbon footprint of our business are our commitments for Sustainable Development.

\* Registration, Evaluation and Authorisation of Chemicals

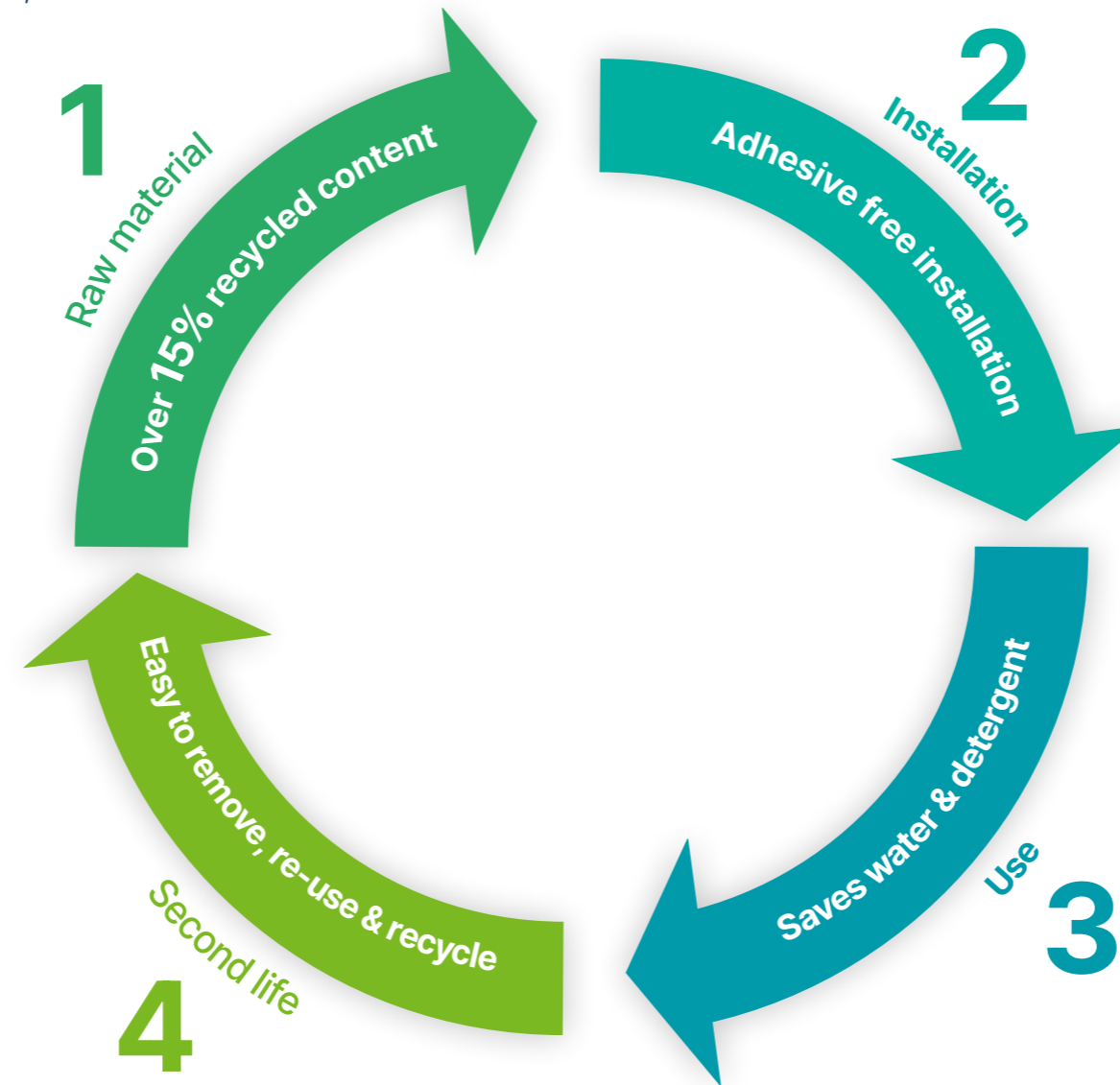

### 2- Installation

made easy in busy environments

**hop** Reinforced holding tape!

Adhesive free

Reduced downtime

Qualifies for the **Second Life Programme**

### 3- Use

Long-lasting performance

**Protecsol® 2**: stain resistant water-repellent surface saves water and detergent

Withstands wheeling heavy loads (straight or circular) up to 500 kg

Excellent resistance to indentation 0.03 mm (compact) / 0.08mm (acoustic)

Excellent stability, even during temperature changes: expansion < 0.03%

Improved resistance to moisture

# Taralay Multilayered

## Taralay Impression hop

### Taralay Impression hop Compact

**TARALAY IMPRESSION HOP COMPACT 0,7** is a multi-layered vinyl floorcovering, integrating a **double fiber frame** and a printed design. It's available in 2 m wide sheet, with a group T wear rating.

The system TARALAY IMPRESSION HOP COMPACT - floorcovering + holding tape « HOP tape », code 059E0001- enables to **lay down flooring gluefree**.

Thanks to its **double fiber frame** -fiber veil + fiber grid-, and its calendared interlayer, the floorcovering achieves a **high level of stability**, even under temperature variations and heavy rolling loads. It can be laid down onto **various existing supports**, including asbestos. Perfectly suitable for renovation or new buildings construction.

Without any glue, its **end life removal is fast and easy**. The Gerflor holding tape doesn't affect the support, to ease renovation. Re-use of the floorcovering, recycle or renovation are then facilitated.

Total width of the product is **2,30 mm**, including a transparent wear layer of 0.70 mm thick. It offers **8 dB sound insulation** and an **indentation resistance of ca. 0.03 mm**. Its **dimensional stability** performs down to **0,03%** (average measure).

**TARALAY IMPRESSION HOP COMPACT** is made in France and contains 23% of recycled content.

The flooring is equipped with **Protecsol® 2**, patented surface treatment obtained by UV laser cross-linking offering the best chemical resistance to the main products used in healthcare environment as betadine, eosin, hydro alcoholic solutions, making the maintenance easy and the floor long lasting. This treatment avoids applying any acrylic emulsion throughout the lifetime of the product.

It is **free of formaldehyde, heavy metals and CMR 1 & 2 or vPvB** (very persistent and very bio accumulative) or PBT (persistent, bio-accumulative and toxic) and is 100% REACH compliant. Its VOC emissions after 28 days (ISO 16000-6) are below detection levels (<10 µg / m³) and this product is classified A + (the best class) and Floorscore® & M1 certified for indoor air quality. Taralay Impression Compact has antibacterial efficacy (E.coli / S.aureus / MRSA): >99% after 24 hours according to ISO22196.

It's **100% recyclable**, and the floorcovering will have its individual EPD sheet.

### Taralay Impression hop Acoustic

**TARALAY IMPRESSION HOP ACOUSTIC 0,7** is a multi-layered vinyl floorcovering, integrating a **double fiber frame**, a **Very High Density foam** backing and a printed design. It's available in 2 m wide sheet, with a group T wear rating.

The system **TARALAY IMPRESSION HOP ACOUSTIC** - floorcovering + holding tape « HOP tape », code 059E0001- enables to **lay down flooring gluefree**.

Thanks to its **double fiber frame** -fiber veil + fiber grid-, and its **calendared interlayer**, the floorcovering achieves a **high level of stability**, even under temperature variations and heavy rolling loads. It can be laid down onto **various existing supports**, including asbestos. Perfectly suitable for renovation or new buildings construction.

Without any glue, its **end life removal is fast and easy**. The Gerflor holding tape doesn't affect the support, to ease renovation. Re-use of the floorcovering, recycle or renovation are then facilitated.

Total width of the product is **4,35 mm**, including a transparent wear layer of 0.70 mm thick. It offers **19 dB sound insulation** and an **indentation resistance of ca. 0.08 mm**. Its **dimensional stability** performs down to **0,03%** (average measure).

**TARALAY IMPRESSION HOP ACOUSTIC** is made in France and contains 23% of recycled content.

The flooring is equipped with **Protecsol® 2**, patented surface treatment obtained by UV laser cross-linking offering the best chemical resistance to the main products used in healthcare environment as betadine, eosin, hydro alcoholic solutions, making the maintenance easy and the floor long lasting. This treatment avoids applying any acrylic emulsion throughout the lifetime of the product.

It is **free of formaldehyde, heavy metals and CMR 1 & 2 or vPvB** (very persistent and very bio accumulative) or PBT (persistent, bio-accumulative and toxic) and is 100% REACH compliant. Its VOC emissions after 28 days (ISO 16000-6) are below detection levels (<10 µg / m³) and this product is classified A + (the best class) and Floorscore® & M1 certified for indoor air quality. Taralay Impression Compact has antibacterial efficacy (E.coli / S.aureus / MRSA): >99% after 24 hours according to ISO22196.

It's **100% recyclable**, and the floorcovering will have its individual EPD sheet.

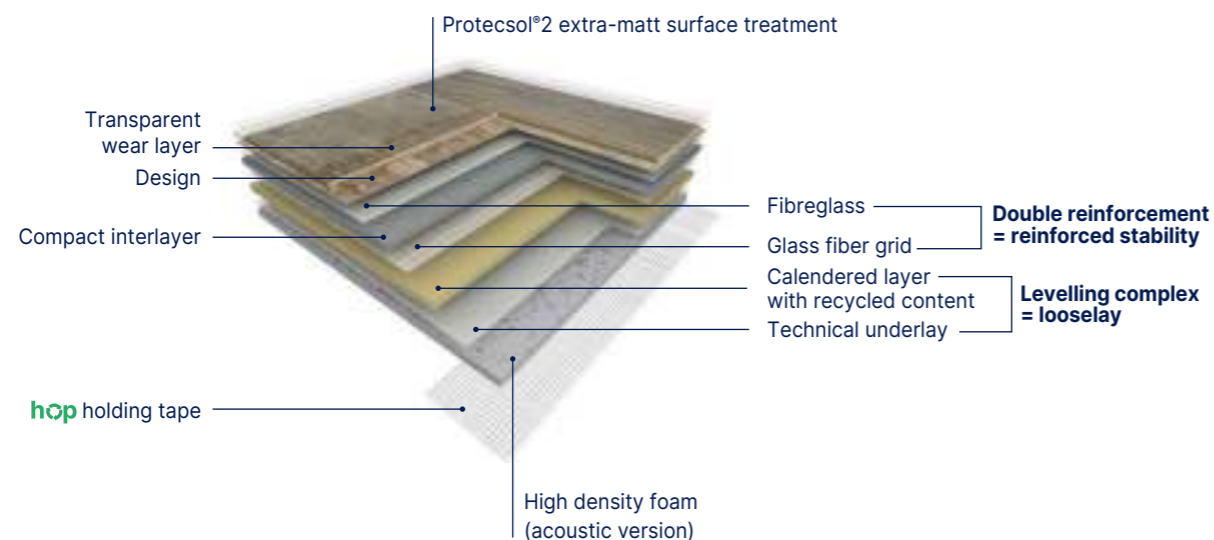

- **Innovative & eco designed solution for looselay installation**
- **Gluefree solution means quick and easy:** save up to 50% installation time
- **23% recycled content inside**

- **Protecsol®2 surface treatment:** the best stain resistance thanks to water-repellent properties
- **Acoustic version:** VHD foam for an acoustic insulation (-19db) - walking wellness and low impact sound

Description	Taralay Impression hop Compact		Taralay Impression hop Acoustic	
Total thickness	EN ISO 24346	mm	2.30	4.35
Wearlayer Thickness	EN ISO 24340	mm	0.70	0.70
Weight	EN ISO 23997	g/sqm	3125	3670
Width of sheet	EN ISO 24341	cm	200	200
Length of sheet	EN ISO 24341	lm	20	20
Phthalate free	-	-	OK	OK
<b>Classification</b>				
Norm / Product specification	-	-	EN ISO 10582	EN ISO 11638
European classification	EN ISO 10874	class	34-43	34-42
Fire rating	EN 13501-1	class	Bfl-s1	Bfl-s1
Static electrical propensity	EN 1815	kV	< 2	< 2
Slip resistance	EN 16165:2021 - Appendix B (DIN 51 130)	class	R10	R10
<b>Performances</b>				
Wear resistance	EN 660.2	mm³	≤ 2.0	≤ 2.0
Wear group	-	group	T	T
Type Binder content	EN ISO 10582	type	I	I
Dimensional stability (requirement)	EN ISO 23999	%	≤ 0.40	≤ 0.40
Dimensional stability (measured value)	-	%	0,03	0,03
Residual indentation (requirement)	EN ISO 24343-1	mm	≤ 0.10	≤ 0.20
Residual indentation (average measured value)	-	mm	≈ 0.03	≈ 0.08
Impact sound insulation	EN ISO 717-2	dB	8	19
Castor chair test (type H)	ISO 4918	-	OK	OK
Thermal conductivity	EN ISO 10456	W/(m.k)	0.25	0.25
Colour fastness	EN ISO 105-B02	degree	≥ 6	≥ 6
Surface treatment	-	-	PROTECSOL® 2	PROTECSOL® 2
Chemical products resistance <sup>(1)</sup>	EN ISO 26987	-	OK	OK
<b>Environment</b>				
Recycled content (average)	-	%	23	23
Recyclability	-	%	100	100
EPD	-	-	Available	Available
<b>Health</b>				
TVOC after 28 days	ISO 16000-6	microgram/m³	< 10	< 10
Certification	-	-	Floorscore®	Floorscore®
Anti-bacterial activity (E. coli - S. aureus - MRSA) after 24h <sup>(2)</sup>	ISO 22196	-	> 99% inhibits growth	> 99% inhibits growth
Anti-viral activity (human coronavirus) after 2h <sup>(2)</sup>	ISO 21702	-	> 99.7% virucidal activity	> 99.7% virucidal activity
<b>CE Marking</b>				



EN 14041



(1) Regarding the resistance to chemicals, please download the corresponding leaflet from our website.  
 (2) The implementation of an effective cleaning regime is the most important defence against infection.

# Taralay Multilayered

Taralay Impression / Taralay Impression **hop**

 Compact
  Acoustic
 19 dB
  Protectsol® 2
  100% recyclable



1104 Wood Fusion Nature

Wood Fusion



1104 Wood Fusion Nature   Scale 5% Digital print 20 cm 



1100 Habana 3D Blossom

Habana 3D



1100 Habana 3D Blossom   Scale 10% Digital print 16,6 cm 



1069 Habana 3D Trinidad  16,6 cm 



1070 Habana 3D Vinales  16,6 cm 



1110 Rivau Nature

Rivau Nature



1110 Rivau Nature   Scale 30% 7 x 35 cm 

\*Available in Taralay Impression **hop**



1077 Raintree Natural

Raintree



1077 Raintree Natural  2,5 cm 



1076 Raintree Grey  2,5 cm 

\*Available in Taralay Impression **hop**

# Taralay Multilayered

Taralay Impression / Taralay Impression **hop**

 Compact 
  Acoustic 
 19 dB 
  Protectsol® 2 
  100% recyclable



## Nature Oak



1055 Nature Oak Clear  16,6 cm 



1053 Nature Oak Blond  16,6 cm 



1056 Nature Oak Dark  16,6 cm 



1054 Nature Oak Brown  16,6 cm 

## Noma



0519 Noma Beige  16,6 cm 



0373 Noma Ice  16,6 cm 

\*Available in Taralay Impression **hop**



## Charme



1093 Charme Kraft  20 cm 



0723 Charme Pecan  20 cm 

## Walnut



1314 Walnut Brown  10 cm 



## Moon Island



0760 Moon Island  16,6 cm 

\*Available in Taralay Impression **hop**

# Taralay Multilayered

Taralay Impression / Taralay Impression **hop**

 Compact
  Acoustic
 19 dB
  Protectsol® 2
  100% recyclable



0725 Sycamore Light Brown

## Sycamore



0725 Sycamore Light Brown



No plank  
Continuous design



0727 Sycamore Vanilla



No plank  
Continuous design



0773 Portobello

## Portobello



0773 Portobello



16,6 cm



0720 Infinity Aube

## Infinity



0680 Infinity Greige



No plank  
Continuous design



0720 Infinity Aube



No plank  
Continuous design

\*Available in Taralay Impression **hop**

# Taralay Multilayered

Taralay Impression / Taralay Impression **hop**

 Compact 
  Acoustic 
 19 dB 
  Protectsol® 2 
  100% recyclable



## Cemento

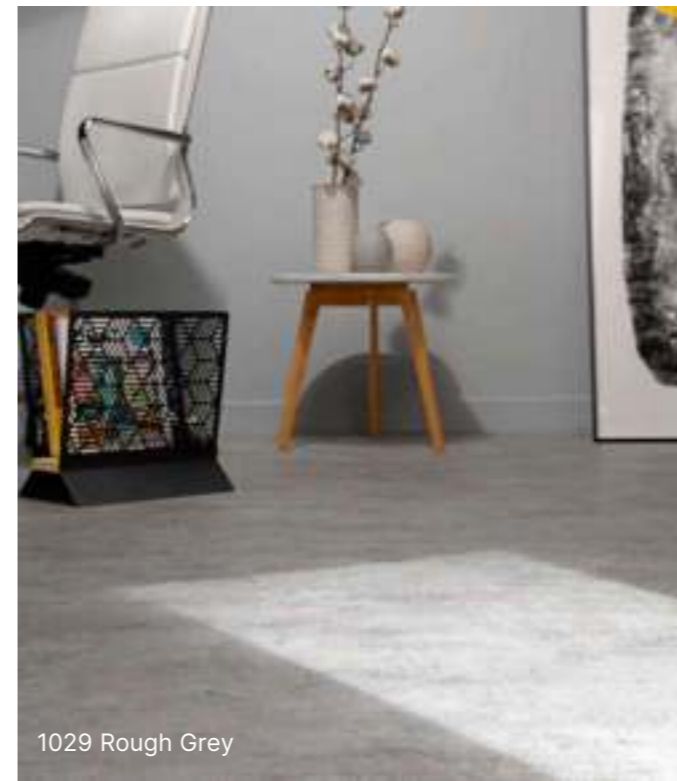
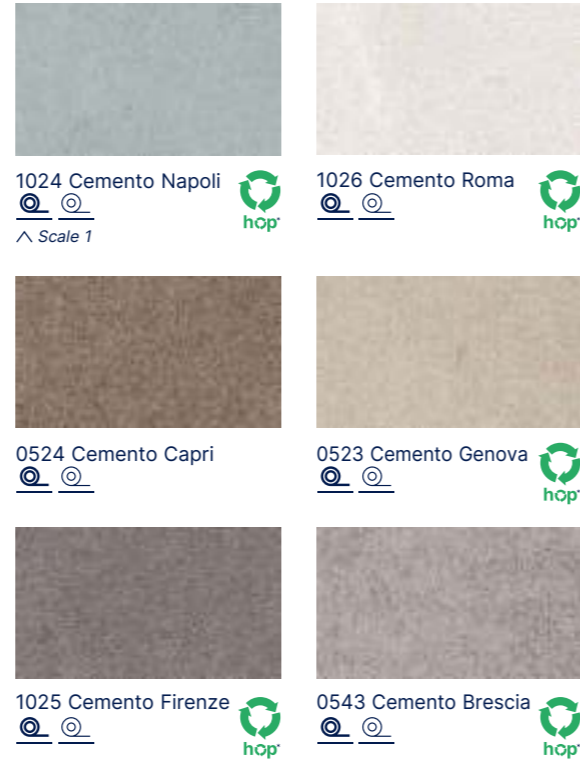

## Rough



## Terrazzo



\*Available in Taralay Impression **hop**



## Riverside

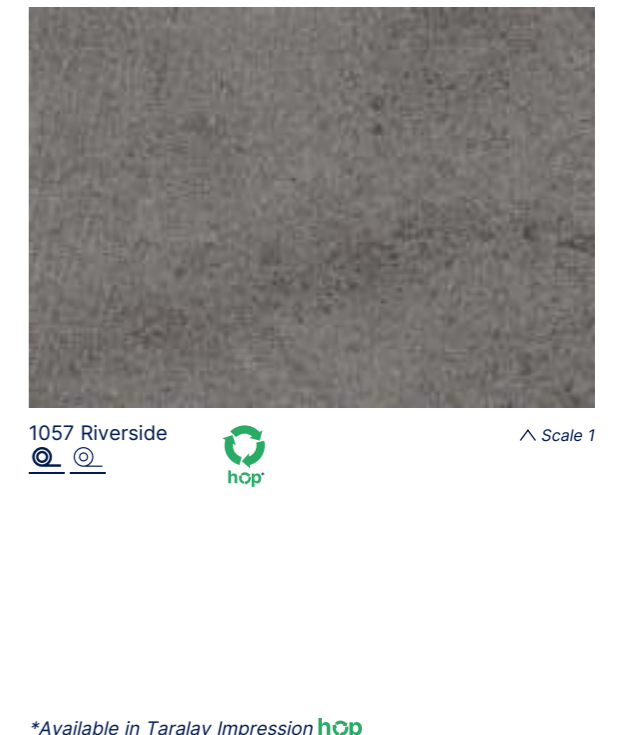

\*Available in Taralay Impression **hop**

# Taralay Multilayered

Taralay Impression / Taralay Impression **hop**

 Compact
  Acoustic
 19 dB
  Protectsol® 2
  100% recyclable



## Gentlemen



1068 Gentlemen Denim 



1067 Gentlemen Black & White 



0770 Gentlemen Clear  



## Pure Wool



1072 Pure Wool Grey 

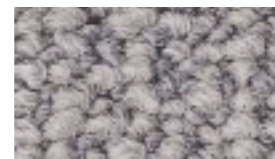

1071 Pure Wool Taupe 



1074 Pure Wool Teal 





1073 Pure Wool Beige 

\*Available in Taralay Impression **hop**



1063 Finesse Brown 



1064 Finesse Nature  



1065 Finesse Paille 



1066 Finesse Poudre 

\*Available in Taralay Impression **hop**

# Taralay Multilayered

Taralay Impression / Taralay Impression **hop**

 Compact
  Acoustic
 19 dB
  Protectsol® 2
  100% recyclable



## Envol



1099 Envol Forest   Scale 1  
 Digital print



1098 Envol Black & White  Digital print



## Nido

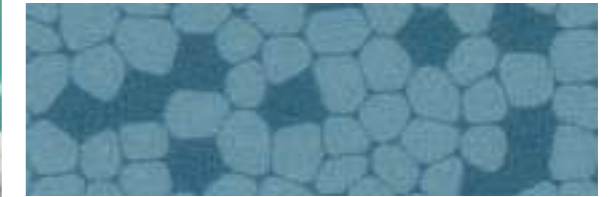

1037 Nido Teal  Scale 1  
 Digital print



1036 Nido Brick  Digital print



1062 Nido Beige  Digital print



1035 Nido Grey  Digital print



## Jungle



1039 Jungle Green  Scale 1  
 Digital print



1038 Jungle Copper  Digital print



1040 Jungle Grey  Digital print

\*Available in Taralay Impression **hop**



## Rice



0736 Rice Champa  Scale 1  
 Digital print



0763 Rice Greige  Digital print



0737 Rice Souris  Digital print

# Taralay Multilayered

## Taralay Impression



19 dB

Protecsol® 2



100% recyclable



1050 Kubes Indigo / 1042 Flipkube Indigo

### Kubes

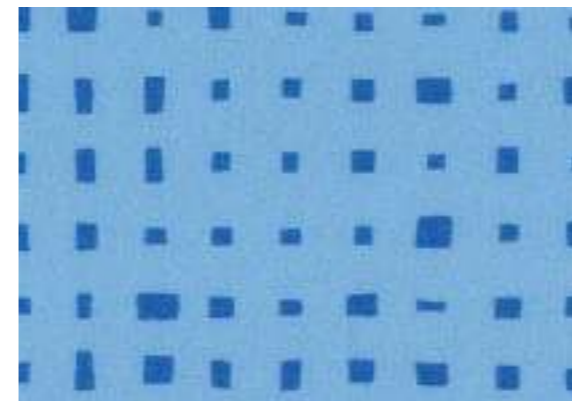

1050 Kubes Indigo



^ Scale 1



0755 Kubes White



^ Scale 1



1030 Kubes Fuschia



1031 Kubes Carmine



1047 Kubes Lemon



1027 Kubes Corail



1046 Kubes Anis



### Flipkube



1042 Flipkube Indigo



^ Scale 1



1045 Flipkube White



^ Scale 1



1044 Flipkube Lagoon



1075 Flipkube Purple



1043 Flipkube Garden



# Taralay Multilayered

Taralay Impression / Taralay Impression **hop**

 Compact 
  Acoustic 
 19 dB 
  Protectsol® 2 
  100% recyclable



## Metallic



1048 Metallic Gold

^ Scale 1



1049 Metallic Silver



## Nest



1051 Nest Blue

^ Scale 1



0745 Nest Metal



1052 Nest White



\*Available in Taralay Impression **hop**



## Chess Black & White



1041 Chess Black & White

^ Scale 10%

25x25 cm 

# Taralay Multilayered

## Taralay Impression

 Compact
  Acoustic
 19 dB
  Protectsol® 2
  100% recyclable





### Happy Number



1102 Happy Number Blue  
  ^ Scale 5%  
Digital print



1103 Happy Number Grey  
  ^ Scale 5%  
Digital print



### Happy Form



1101 Happy Form  
  ^ Scale 5%  
Digital print



### Happy Road



0923 Happy Road  
  ^ Scale 10%  
Digital print

# Taralay Multilayered

Taralay Impression / Taralay Impression **hop**

 Compact
  Acoustic
 19 dB
  Protectsol® 2
  100% recyclable



1092 Uni Matt Light Beige / 1103 Happy Number Grey



1084 Uni Matt Jungle Grey  
 

^ Scale 1



0832 Uni Matt Grey  
 

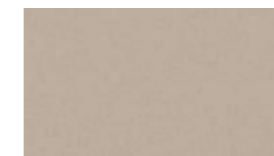

1088 Uni Matt Dark Beige  
 



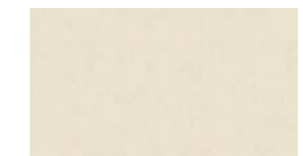

1092 Uni Matt Light Beige  
 



0848 Uni Matt White  
 



1091 Uni Matt Corail  
 



1089 Uni Matt Copper  
 



1090 Uni Matt Brick  
 



1086 Uni Matt Poudre  
 



1087 Uni Matt Yellow  
 



1082 Uni Matt Light Green  
 



1081 Uni Matt Lagoon  
 



1078 Uni Matt Indigo  
 



1080 Uni Matt Green  
 



1079 Uni Matt Dark Green  
 



1085 Uni Matt Teal  
 



1083 Uni Matt Navy  
 

\*Available in Taralay Impression **hop**

# Taralay Multilayered

My Taralay Impression

## Beyond the norm

As you are unique and each of your projects represents a new challenge, Gerflor gives you the chance to stand out, from 200 sqm.

One atmosphere, one style, one floor, but several possibilities...

## 3 possibilities



### 1 - COLOUR

the possibility to recolour 32 designs in the Taralay Impression range as you wish



1

Select a design\* from the Taralay Impression range



2

Change the colour scheme as you wish



3

Receive your floor sample within 10 days of acceptance of your inquiry by Gerflor



4

Receive and install your customised flooring; delivery lead time: 6 weeks from receipt of your order

\* from among 32 eligible designs (see Brochure My Taralay Impression)

"ENVOL" DESIGN  
STANDARD COLOUR SCHEME



CUSTOMISED COLOUR 1



CUSTOMISED COLOUR 2



# Taralay Multilayered

My Taralay Impression



## 2 - COLLECTION

the possibility to select from among **50 exclusive designs**

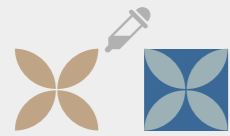

1

Draw inspiration from Gerflor's 50 exclusive designs and change, if you so wish, the design's colour scheme on [www.myfloorbygerflor.com](http://www.myfloorbygerflor.com)



2

View your customised design on your computer screen before approving it

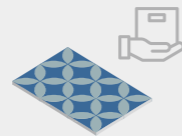

3

Receive your floor sample within 10 days of acceptance of your inquiry by Gerflor

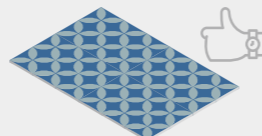

4

Receive and install your customised flooring; delivery lead time: 6 weeks from receipt of your order



## 3 - CUSTOMISATION

the possibility to make your floor unique



1

Send us your own file in accordance with the process described in our **specifications**



2

Approval by our technical team

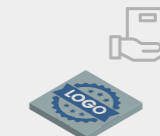

3

Receive your floor sample within 10 days and before all of your floor is made

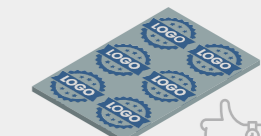

4

Receive and install your customised flooring; delivery lead time: 6 weeks from receipt of your order



File formats accepted



Files free from copyright only



300 DPI resolution



RAL, Pantone and NCS colour reference



To enhance the visual identity of your company or that of your clients, you can have your logo printed across the width of the roll.

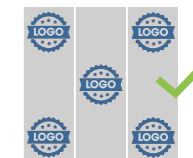

- No metallic ink
- No printing on a plain background
- Design only across the width (2 m)
- No continuity of designs over several rolls



# Taralay Multilayered

## Taralay Initial New

### Taralay Initial Compact

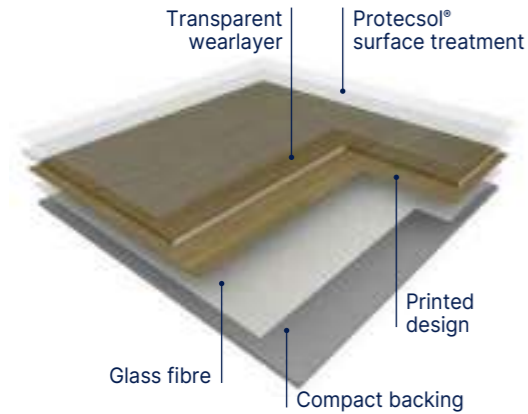

**TARALAY INITIAL COMPACT** is a multi-layered vinyl floorcovering, available in 2 m wide sheet, with a group T wear rating.

The product comprises a compacted backing reinforced with a glass fibre and a printed design that is protected by a transparent wear layer (0.70 mm thick). It offers 6 dB sound insulation and an indentation resistance of 0.03 mm.

It is treated with **ProtecSol®**, a UV cured surface treatment, which facilitates ease of maintenance and eliminates permanently the need for acrylic emulsion (metallisation).

According to ISO 21702, **TARALAY INITIAL COMPACT** has **anti-viral activity** against Human Coronaviruses: it reduces the number of virus by 99.3% after 2h.

According to ISO 22196, **TARALAY INITIAL COMPACT** has **anti-bacterial activity** against E. coli, S. aureus and MRSA of 99% after 24h.

These products do not contain any heavy metals or CMR 1&2 and are 100% compliant with REACH. The products emission rate of volatile organic compounds is < 10 microgram/m<sup>3</sup> (TVOC after 28 days – ISO 16000-6).

It is 100% recyclable.

### Taralay Initial Acoustic

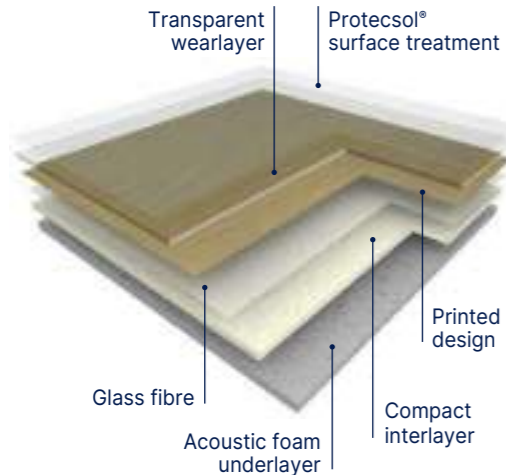

**TARALAY INITIAL ACOUSTIC** is an acoustic multi-layered vinyl floorcovering, available in 2 m wide sheet, with a group T wear rating.

The product comprises a foam backing reinforced with a glass fibre and a printed design that is protected by a transparent wear layer (0.65 mm thick). It offers **19 dB** sound insulation and an indentation resistance of 0.10 mm.

It is treated with **ProtecSol®**, a UV cured surface treatment, which facilitates ease of maintenance and eliminates permanently the need for acrylic emulsion (metallisation).

According to ISO 21702, **TARALAY INITIAL ACOUSTIC** has **anti-viral activity** against Human Coronaviruses: it reduces the number of virus by 99.3% after 2h.

According to ISO 22196, **TARALAY INITIAL ACOUSTIC** has **anti-bacterial activity** against E. coli, S. aureus and MRSA of 99% after 24h.

It does not contain any heavy metals or CMR 1&2 and is 100% compliant with REACH. The products emission rate of volatile organic compounds is < 10 microgram/m<sup>3</sup> (TVOC after 28 days – ISO 16000-6).

It is 100% recyclable.



19 dB

ProtecSol®



100% recyclable

- All references are available in **Compact** and **Acoustic**
- High resistance to indentation **0.03 mm (Compact)** and **0.10 mm (Acoustic)**
- High impact insulation **6 dB (Compact)** and **19 dB (Acoustic)**
- **ProtecSol®** Surface Treatment (easy maintenance & no wax)
- Highest performance in **TVOC emission < 10 microgram/m<sup>3</sup>**

Description			Taralay Initial Compact Pro	Taralay Initial Acoustic Pro
<b>Classification</b>				
Norm / Product specification	-	-	EN ISO 10582	EN ISO 11638
European classification	EN ISO 10874	class	34-43	34-42
Fire rating	EN 13501-1	class	Bfl-s1	Bfl-s1
Static electrical propensity	EN 1815	kV	< 2	< 2
Slip resistance wet	EN 16165:2021 – Appendix B (DIN 51 130)	class	R10	R10
<b>Performances</b>				
Wear resistance	EN 660.2	mm <sup>3</sup>	≤ 2.0	≤ 2.0
Wear group	-	group	T	T
Type Binder content	EN ISO 10582	type	I	-
Dimensional stability	EN ISO 23999	%	≤ 0.40	≤ 0.40
Residual indentation (requirement)	EN ISO 24343-1	mm	≤ 0.10	≤ 0.20
Residual indentation (average measured value)	-	mm	≈ 0.03	≈ 0.10
Impact sound insulation	EN ISO 717-2	dB	6	19
Castor chair test (type H)	ISO 4918	-	OK	OK
Thermal conductivity	EN ISO 10456	W/(m.k)	0.25	0.25
Colour fastness	EN ISO 105-B02	degree	≥ 6	≥ 6
Surface treatment	-	-	ProtecSol®	ProtecSol®
Chemical products resistance	EN ISO 26987	-	OK	OK
<b>Environment</b>				
Recycled content (average)	-	%	14	17
Recyclability	-	%	100	100
EPD	-	-	Available	Available
<b>Health</b>				
TVOC after 28 days	ISO 16000-6	microgram/m <sup>3</sup>	< 10	< 10
Certification	-	-	Floorscore®	Floorscore®
Anti-bacterial activity (E. coli - S. aureus - MRSA) <sup>(1)</sup>	ISO 22196	-	> 99% inhibits growth	> 99% inhibits growth
Anti-viral activity (human coronavirus) after 2h <sup>(1)</sup>	ISO 21702	-	> 99.3% virucidal activity	> 99.3% virucidal activity
<b>CE marking</b>				



EN 14041



(1) The implementation of an effective cleaning regime is the most important defence against infection.

# Taralay Multilayered

Taralay Initial **New**



19 dB

Protectsol®



100% recyclable



## Chicago



1242 Chicago Sage



^ Scale 1



1279 Chicago Mint



1245 Chicago Haze



1249 Chicago Storm



1278 - Chicago Sunshine



1244 - Chicago Cream



1247 Chicago Sand



1281 Chicago Coral



1243 Chicago Terra



1248 Chicago Sirocco



1280 Chicago Sky



1246 Chicago Hurricane



1250 Chicago Typhoon



1282 Chicago Ocean



1254 Cottage Clear /  
1242 Chicago Sage /  
1260 Terrazzo Sage



1283 Fiesta Rainbow

## Fiesta Rainbow



1283 Fiesta Rainbow



^ Scale 50%



1261 Terrazzo Terra - 1238 Azay Cream

## Terrazzo

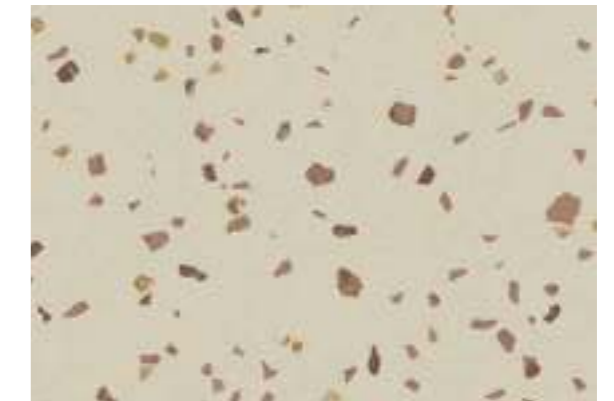

1261 Terrazzo Terra



^ Scale 1



1260 Terrazzo Sage



# Taralay Multilayered

Taralay Initial **New**

 Compact
  Acoustic
 19 dB
  Protocolsol®
  100% recyclable



Cordoba Black & White



2226 Cordoba Black & White

^ Scale 15%

Verone Navona



1263 Verone Navona

^ Scale 1

Filament



1256 Filament Golden

No plank  
Continuous design



0799 Filament Light

No plank  
Continuous design



0271 Filament Alto

No plank  
Continuous design



Bali



1239 Bali Beige

^ Scale 1



1240 Bali Gris

Valencay



1442 Valencay Pecan

16,6 cm



0179 Valencay Patine

16,6 cm



0368 Valencay Blond

16,6 cm

# Taralay Multilayered

## Taralay Initial New



19 dB

Protecsol®



100% recyclable



1238 Azay Cream

### Esterel



0636 Esterel Blond



1255 Esterel Clear



### Azay

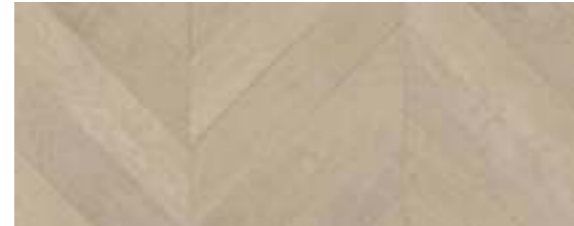

1238 Azay Cream



1271 Azay Gold



### Moon Island



0760 Moon Island



### Habana 3D



0797 Habana 3D Ivory



0828 Habana 3D Beige



### Cottage



1252 Cottage Brown



1253 Cottage Cinnamon



1251 Cottage Blond



1254 Cottage Clear



1252 Cottage Brown

### Bostonian



0961 Bostonian Honey



1241 Bostonian Chatain



### Pattern repeat Taralay Initial

Colour Reference	Colour Name	Pattern Repeat		Drawing dimension
		Width	Length	
1238	Azay Cream	1000	1000	75 × 350
1271	Azay Gold	1000	1000	75 × 350
1239	Bali Beige	1000	1000	all-over
1240	Bali Gris	1000	1000	all-over
1241	Bostonian Chatain	1000	1000	200 × 1000
0961	Bostonian Honey	1000	1000	200 × 1000
1281	Chicago Coral	1000	1000	all-over
1244	Chicago Cream	1000	1000	all-over
1245	Chicago Haze	1000	1000	all-over
1246	Chicago Hurricane	1000	1000	all-over
1279	Chicago Mint	1000	1000	all-over
1282	Chicago Ocean	1000	1000	all-over
1242	Chicago Sage	1000	1000	all-over
1247	Chicago Sand	1000	1000	all-over
1248	Chicago Sirocco	1000	1000	all-over
1280	Chicago Sky	1000	1000	all-over
1249	Chicago Storm	1000	1000	all-over
1278	Chicago Sunshine	1000	1000	all-over
1243	Chicago Terra	1000	1000	all-over
1250	Chicago Typhoon	1000	1000	all-over
2226	Cordoba Black & White	1000	1000	250 × 250
1251	Cottage Blond	1000	1000	200 × 1000
1252	Cottage Brown	1000	1000	200 × 1000
1253	Cottage Cinnamon	1000	1000	200 × 1000
1254	Cottage Clear	1000	1000	200 × 1000
0636	Esterel Blond	1000	1000	100 × 1000
1255	Esterel Clear	1000	1000	100 × 1000
1283	Fiesta Rainbow	1000	1000	all-over
0271	Filament Alto	1000	1000	all-over
1256	Filament Golden	1000	1000	all-over
0799	Filament Light	1000	1000	all-over
0828	Habana 3D Beige	1000	1000	166 × 1000
0797	Habana 3D Ivory	1000	1000	166 × 1000
0760	Moon Island	1000	1000	166 × 1000
1260	Terrazzo Sage	1000	1000	all-over
1261	Terrazzo Terra	1000	1000	all-over
1704	Valencay Blond	1000	1000	166 × 1000
0179	Valencay Patine	1000	1000	166 × 1000
1262	Valencay Pecan	1000	1000	166 × 1000
1263	Verone Navona	1000	1000	333 × 500

European Creation Tiles & Planks  
manufacturer since 1985

- 7 Tiles & Planks factories  
including 5 in Europe
- Stock in Europe  
12 logistics hubs
- Internal Design Center  
> exclusive designs

# The Reference in Tiles & Planks

## Creation Tiles & Planks

pages 104-183

- 108. **Creation 30/40/55/70 Dry Back** **New**  
**Creation 40/55/70 Clic** **New**  
**Creation 40/55 Clic Acoustic** **New**
- 134. **Creation 55 Looselay /**  
**Looselay Acoustic**  
**Creation 70 Looselay**
- 150. **Creation Saga<sup>2</sup>**
- 156. **Creation 70 Connect**
- 160. **Creation 70 Megaclitc** **New**
- 168. **Creation 40 /55/70 Zen**
- 178. **My Creation**  
**My Creation Zen**  
**My Saga**
- 180. **Technical data**

# Creation Tiles & Planks

Full technical data sheet pages 180/183

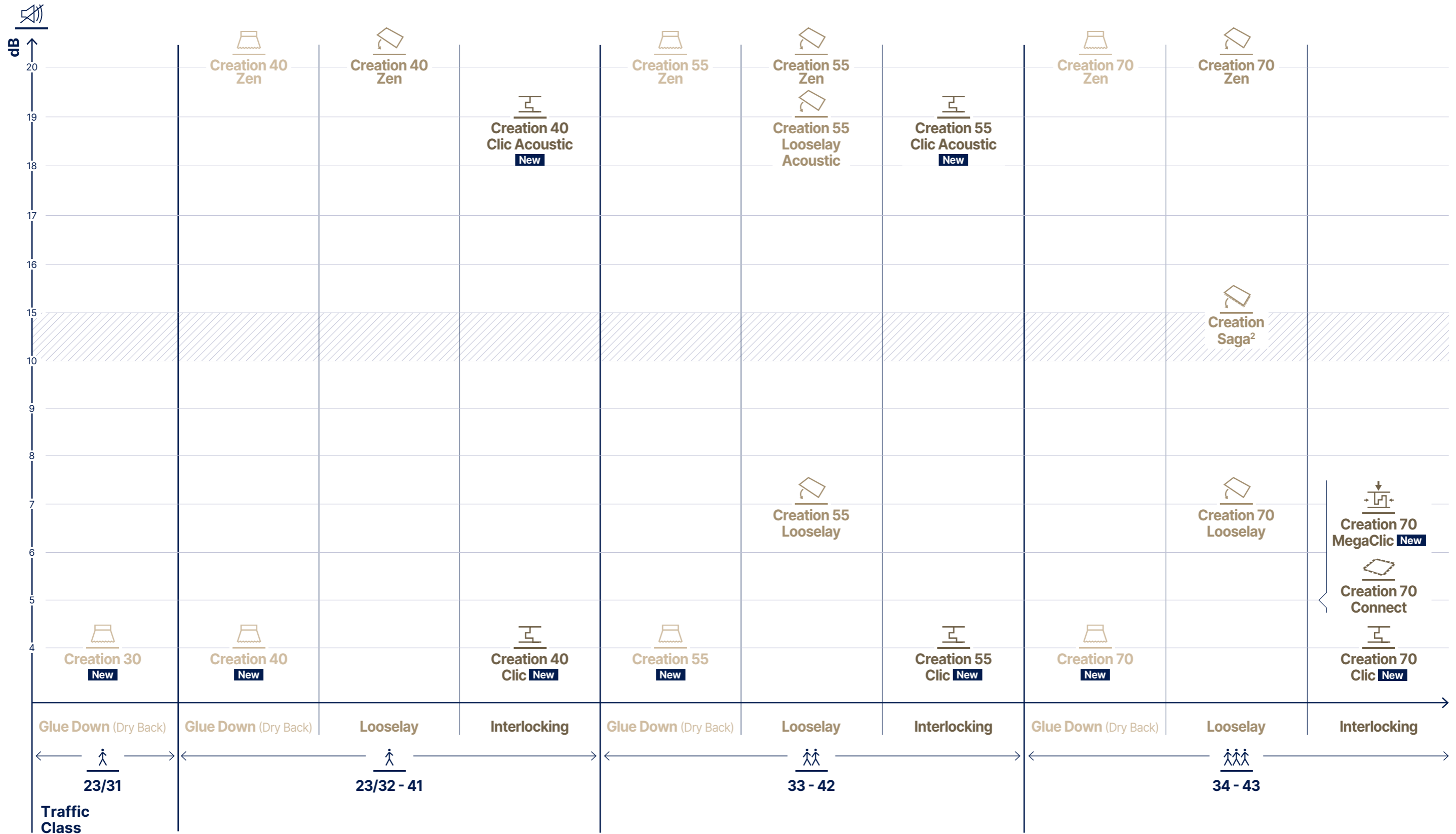

Visualize your design in any room setting on [gerflor.com](https://gerflor.com) > Services > Interior Designer

Create  
without limits



# New Collection Creation 30/40/55/70

Creation  
Tiles & Planks

**85** colors

**12** formats

**100%** coordinated

Inspired by the latest interior design trends, a collection with **shades and woodgrains carefully selected for perfect harmony.**

#### Ultra-natural look & feel

Textures inspired by raw materials, with authentic, ultra-realistic finishing touches.

#### Acoustic & thermal comfort

Reduced footstep sounds, improved insulation, and a constant pleasant temperature assured.

#### Harmony: from floor to wall

Creation & Revela Wall: endless possibilities to reach perfect harmony.

Our collections are designed for easy mix and match.

#### All your needs in one Collection

Available for every application and traffic requirement, for new built or renovation, with or without acoustic.



Creation: Aquinoah Nature - Luna Cobalt  
Mural Revela: Concrete Cream

Creation: Bloom Uni Cream  
Mural Revela: Concrete Cream

# Creation Tiles & Planks

Creation 30/40/55/70 - Dry Back / Clic / Clic Acoustic  
Unique construction to maximize comfort



## ① Exclusive ProtecShield™ surface treatment

- Long-lasting Protection
- Ease of maintenance
- Durable Matte finish



## ② Smart design

Expanded design variation for minimized repetition (Doubled pattern design)



## ③ Acoustic Top Layer

- Acoustic Comfort (in the room)
- Thermal Comfort
- Walking Comfort



## ④ Rigid Core

(Creation Clic & Clic Acoustic)

- Effortless Installation
- User-Friendly Installation
- Durability



## ⑤ Acoustic back Layer

(Creation Acoustic & Clic Acoustic)

- Acoustic Comfort (in the room)
- Walking Comfort



## Creation 30 / 40 / 55 / 70 Dry Back

**CREATION DRY BACK** is a synthetic, decorative, and flexible PVC flooring solution, available in planks and tiles with four-sided beveled edges. It features a 0,70 mm wear-layer in CREATION 70, 0,55 mm in CREATION 55, 0,40 mm in CREATION 40, and 0,30 mm in CREATION 30. It has a high definition printed decorative film, offering an extensive design variety. The product also includes an acoustic top layer for enhanced walking comfort, along with a resilient core that facilitates easy cutting during installation.

With a total thickness of 2,5mm in CREATION 70 / 55, 2 mm in CREATION 40/30,

It benefits from a crosslinked polyurethane surface treatment (**Protecshield™**), which ensures easy maintenance and improved resistance to micro-scratches.

**CREATION DRY BACK** is designed for glue-down installation. It is classified as Bfl-s1 according to EN 13501-1 fire safety standard.

It meets the following European usage classification: 34/43 in CREATION 70, 33/42 in CREATION 55, 23/32-41 in CREATION 40, and 23/31 in CREATION 30.

**CREATION DRY BACK** is free from phthalates (except for recycled content) and is 100% recyclable. Installation offcuts and end-of-life material, under certain conditions, can be collected and recycled through Gerflor's "Second Life" program. The product contains an average of 35% recycled content and complies with REACH regulations. Its indoor air quality performance is excellent, with TVOC emissions after 28 days (NF EN 16000) below 10 µg/m³, earning an A+ rating - the highest level under health labeling standards, Floorscore®, IAC Gold & M1.

## Creation 40 / 55 / 70 Clic

**CREATION CLIC** is a decorative, flexible flooring solution, classified in abrasion group T, available in planks and tiles with four-sided beveled edges.

It features a 0,70 mm wear-layer in CREATION 70 CLIC, 0,55 mm in CREATION 55 CLIC and 0,40 mm in CREATION 40 CLIC. It has a high definition printed decorative film, offering an extensive design variety.

The product also includes an acoustic top layer for improved walking comfort and easier cutting during installation and a rigid core, which allows installation over existing subfloors, making it suitable for renovation projects.

The total thickness is 5mm in CREATION 55/70 CLIC and 4,5 mm in CREATION 40 CLIC;

It benefits from a cross-linked polyurethane surface treatment (**Protecshield™**), which facilitates maintenance and provides resistance to micro-scratches.

**CREATION CLIC** is quick and easy to install thanks to its Gerflor Fold Down clic system: vertical locking on the short side and horizontal locking on the long side.

It is classified Bfl-s1 according to the fire standard EN 13501-1. It meets the following European usage classification: 34/43 in CREATION 70 CLIC, 33/42 in CREATION 55 CLIC and 23/32-41 in CREATION 40 CLIC.

**CREATION CLIC** is phthalate-free (except for recycled content) and 100% recyclable. Installation offcuts and end-of-life flooring (under certain conditions) can be collected and recycled through the Gerflor "Second Life" program.

It contains an average of 33% recycled content, certified by SCS Global Services (except Creation 70 Clic and Creation 55 Clic Acoustic HB). It complies with REACH regulations. TVOC emissions at 28 days (NF EN 16000) are < 10 µg/m³, rated A+ (the highest rating), and certified Floorscore® and M1.

**CREATION CLIC** has an individual Environmental Product Declaration (EPD), verified and certified by UL Certification.

## Creation 40 / 55 Clic Acoustic

**CREATION CLIC ACOUSTIC** is a decorative, flexible flooring solution, classified in abrasion group T, available in planks and tiles with four-sided beveled edges. It features a 0,55mm wear layer and a 2m high definition printed decorative film, offering maximum design variety.

The product also includes a double acoustic layer:  
- An acoustic top layer for improved walking comfort and easier cutting during installation.  
- An acoustic back layer to enhance sound insulation (19 dB).

Between these two layers is a rigid core, which allows installation over existing subfloors, making it suitable for renovation projects. The total thickness is 6mm.

It benefits from a cross-linked polyurethane surface treatment (**Protecshield™**), which facilitates maintenance and provides resistance to micro-scratches.

**CREATION CLIC ACOUSTIC** is quick and easy to install thanks to its Gerflor Fold Down clic system: vertical locking on the short side and horizontal locking on the long side.

It is classified Bfl-s1 according to the fire standard EN 13501-1. It meets the following European usage classification: 33/42 in CREATION 55 CLIC ACOUSTIC and 23/32-41 in CREATION 40 CLIC ACOUSTIC.

**CREATION CLIC ACOUSTIC** is phthalate-free (except for recycled content) and 100% recyclable. Installation offcuts and end-of-life flooring (under certain conditions) can be collected and recycled through the Gerflor "Second Life" program.

It contains an average of 33% recycled content, certified by SCS Global Services. It complies with REACH regulations. TVOC emissions at 28 days (NF EN 16000) are < 10 µg/m³, rated A+ (the highest rating), and certified Floorscore® and M1.

**CREATION CLIC ACOUSTIC** has an individual Environmental Product Declaration (EPD), verified and certified by UL Certification.

# Creation Tiles & Planks

Creation 30/40/55/70 - Dry Back / Clic / Clic Acoustic

## From floor to wall



Creation: Aquinoah Blond  
Mural Revela: Marmor White

Creation: Bloom Uni Cream  
Mural Revela: Concrete Cream

## Perfect harmony between Creation & Mural Revela

## 7 matching designs Creation & Mural Revela

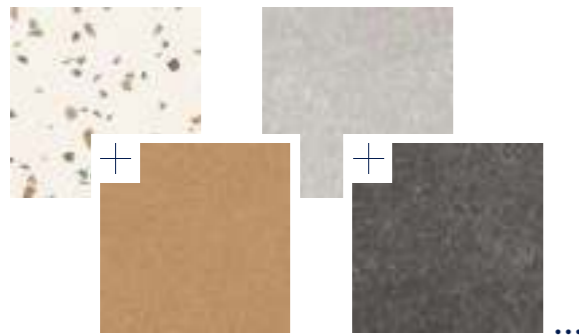

Creation  
1745 Confetti Cobalt  
Mural Revela  
Terrazzo Cobalt



Creation  
1599 Bloom Uni Clear  
Mural Revela  
Concrete Clear



Creation  
1729 Paradiso Bone  
Mural Revela  
Travertine Bone



Creation  
1742 Sahara Noir  
Mural Revela  
Marbre Noir

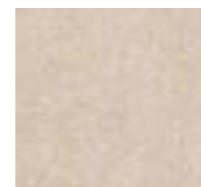

Creation  
1600 Bloom Uni Cream  
Mural Revela  
Concrete Cream



Creation  
1701 Linear Wood Clear  
Mural Revela  
Wood Clear

Full Mural Revela  
collection page 198  
and on gerflor.com

## Ultra Natural Look & Feel

More than 60% of our collection is using our new emboss technology - designed by our Artistic Team.



NEW

### Scandinavian

A delicate surface, with a linear grain that accentuates the orientation of the material.



NEW

### Authentic

Highlighting the wood's cathedral grain for a tactile realism.



### Brushed

The sensory expression of rustic wood, with a structured and random surface.



### Lounge Oak & Charming Oak

The registered surface perfectly follows the grain patterns for visual and tactile consistency.



### Stone

A surface with a fine and uniform texture, evoking the subtle softness of the polished stone or concrete.



### Hammered

A surface with a slightly grainy feel, where subtle irregularities evoke the authenticity of stone.



In addition to these ultra realistic embossing, Protecshield™ surface treatment offers a velvet touch, with a matt surface, ease of maintenance and micro scratch resistance.

# Creation Tiles & Planks

## Creation 30/40/55 - Dry Back / Clic / Clic Acoustic

Formats details on page 132



### Tamo



1598 Tamo Cream

Dry Back: 30 / 40 / 55  
Clic Ac: 40 / 55



1561 Tamo Natural

Dry Back: 30 / 40 / 55  
Clic Ac: 40 / 55



1567 Tamo Clear

Dry Back: 30 / 40 / 55  
Clic Ac: 40 / 55



1568 Tamo Light Brown

Dry Back: 30 / 40 / 55  
Clic Ac: 40 / 55



### Lounge Oak



1272 Lounge Oak Beige

Dry Back: 30 / 40 / 55  
Clic: 40 / 55  
Clic Ac: 40 / 55



1273 Lounge Oak Natural

Dry Back: 30 / 40 / 55  
Clic: 40 / 55  
Clic Ac: 40 / 55



1271 Lounge Oak Golden

Dry Back: 30 / 40 / 55  
Clic: 40 / 55  
Clic Ac: 40 / 55



1274 Lounge Oak Chesnut

Dry Back: 30 / 40 / 55  
Clic: 40 / 55  
Clic Ac: 40 / 55



Lounge Oak Golden

### Quartet



0870 Quartet Honey

Dry Back: 30 / 40 / 55  
Clic: 40 / 55  
Clic Ac: 40 / 55



0503 Quartet

Dry Back: 30 / 40 / 55  
Clic: 40 / 55  
Clic Ac: 40 / 55



0545 Quartet Natural

Dry Back: 30 / 40 / 55  
Clic: 40 / 55  
Clic Ac: 40 / 55



1597 Quartet Dark Brown

Dry Back: 30 / 40 / 55  
Clic: 40 / 55  
Clic Ac: 40 / 55



### Aquinoah



1704 Aquinoah Blond

Dry Back: 30 / 55  
Clic: 55  
Clic Ac: 40 / 55



1707 Aquinoah Nature

Dry Back: 30 / 55  
Clic: 55  
Clic Ac: 40 / 55



1706 Aquinoah Honey

Dry Back: 30 / 55  
Clic: 55  
Clic Ac: 40 / 55



1705 Aquinoah Brown

Dry Back: 30 / 55  
Clic Ac: 40 / 55



Quartet Honey

# Creation Tiles & Planks

## Creation 30/40/55 - Dry Back / Clic / Clic Acoustic

Formats details on page 132



### Savage Oak



1708 Savage Oak Greige

Dry Back: 30 / 55  
Clic Ac: 40 / 55



1709 Savage Oak Honey

Dry Back: 30 / 55  
Clic: 55  
Clic Ac: 40 / 55



1710 Savage Oak Smoked

Dry Back: 30 / 55  
Clic: 55  
Clic Ac: 55



### Cedar



1605 Cedar Dark Brown

Dry Back: 30 / 40 / 55  
Clic: 40 / 55  
Clic Ac: 40 / 55



1606 Cedar Golden

Dry Back: 30 / 40 / 55  
Clic: 40 / 55  
Clic Ac: 40 / 55



0850 Cedar Brown

Dry Back: 30 / 40 / 55  
Clic: 40 / 55  
Clic Ac: 40 / 55



1607 Cedar Natural

Dry Back: 30 / 40 / 55  
Clic: 40 / 55  
Clic Ac: 40 / 55



0441 Honey Oak

Dry Back: 30 / 40 / 55  
Clic: 40 / 55  
Clic Ac: 40 / 55



0347 Ballerina

Dry Back: 30 / 40 / 55  
Clic: 40 / 55  
Clic Ac: 40 / 55



0455 Long Board

Dry Back: 30 / 40 / 55  
Clic: 40 / 55  
Clic Ac: 40 / 55



0504 Twist

Dry Back: 30 / 40 / 55  
Clic: 40 / 55  
Clic Ac: 40 / 55



0584 White Lime

Dry Back: 30 / 40 / 55  
Clic: 40 / 55  
Clic Ac: 40 / 55



0456 Ranch

Dry Back: 30 / 40 / 55  
Clic: 40 / 55  
Clic Ac: 40 / 55



Honey Oak

### Bostonian Oak

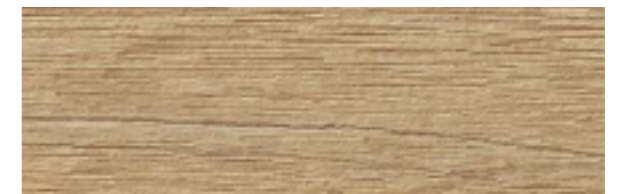

0851 Bostonian Oak Honey

Dry Back: 30 / 40 / 55  
Clic Ac: 40 / 55



0853 Bostonian Oak Beige

Dry Back: 30 / 40 / 55  
Clic Ac: 40 / 55



\*Clic & Clic Acoustic for Cedar designs

116 Design shade variation: Light Medium high

Smart Design by Gerflor offers twice the design variety for a floor that always looks unique.

# Creation Tiles & Planks

Creation 30/40/55 - Dry Back / Clic / Clic Acoustic

## Linear Wood



1702 Linear Wood Honey Dry Back: 55



1701 Linear Wood Clear Dry Back: 55  
Clic: 55  
Clic Ac: 55



1703 Linear Wood Nature Dry Back: 55  
Clic: 55  
Clic Ac: 55



## Charming Oak Emboss in register



1278 Charming Oak Beige Dry Back: 30 / 55  
Clic Ac: 55



1279 Charming Oak Grey Dry Back: 30 / 55  
Clic Ac: 55

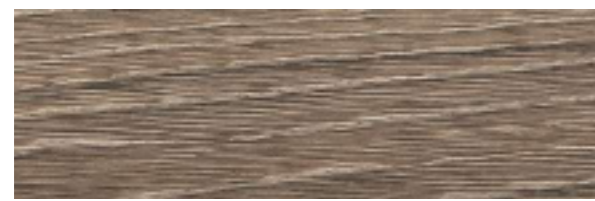

1714 Charming Oak Smoked Dry Back: 30 / 55



\*Clic Acoustic for Charming designs

118 Design shade variation:  Light  Medium  high

## Versailles



1750 Versailles Honey Dry Back: 55



1706 Aquinoah Honey

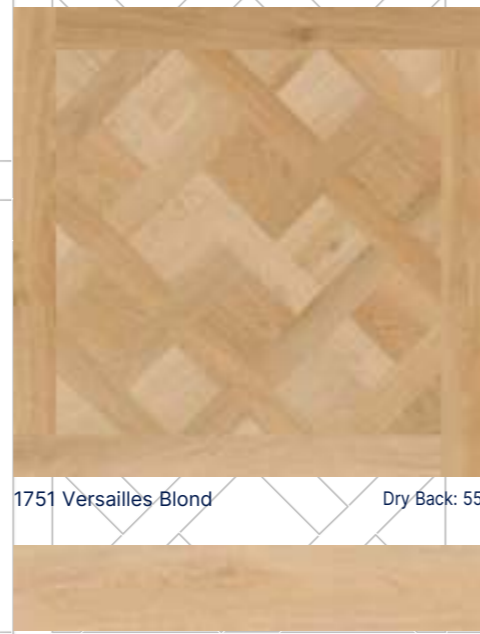

1751 Versailles Blond Dry Back: 55

1704 Aquinoah Blond



Smart Design by Gerflor offers twice the design variety for a floor that always looks unique.

 Formats details on page 132



## Herringbone



1706 Aquinoah Honey Dry Back: 55 / Clic Ac: 55



1704 Aquinoah Blond Dry Back: 55 / Clic Ac: 55



0347 Ballerina Dry Back: 55 / Clic Ac: 55



0504 Twist Dry Back: 55 / Clic Ac: 55



1707 Aquinoah Nature Dry Back: 55 / Clic Ac: 55



0503 Quartet

## Hungarian Point



1706 Aquinoah Honey Dry Back: 55



1704 Aquinoah Blond



Hungarian Point Aquinoah Blond



Herringbone Aquinoah Nature

# Creation Tiles & Planks

## Creation 30/40/55 - Dry Back / Clic / Clic Acoustic

Formats details on page 132



### Bloom Uni

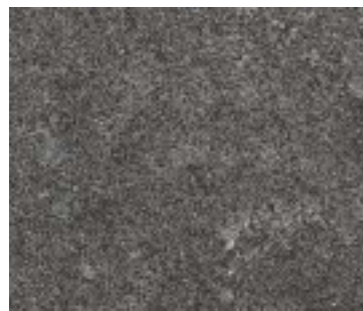

**1601 Bloom Uni Dark**  
Dry Back: 30 / 40 / 55  
Clic: 55  
Clic Ac: 40 / 55



**1602 Bloom Uni Pearl**  
Dry Back: 30 / 40 / 55  
Clic: 55  
Clic Ac: 40 / 55



**1599 Bloom Uni Clear**  
Dry Back: 30 / 40 / 55  
Clic: 55  
Clic Ac: 40 / 55



**1600 Bloom Uni Cream**  
Dry Back: 30 / 40 / 55  
Clic Ac: 40 / 55

### Curton Stone



**1603 Curton Stone Clear**  
Dry Back: 30 / 40 / 55  
Clic: 40 / 55  
Clic Ac: 40 / 55



**1604 Curton Stone Taupe**  
Dry Back: 30 / 40 / 55  
Clic: 40 / 55  
Clic Ac: 40 / 55



Curton Stone Taupe

### Urban Street & Resin Marble



**1283 Urban Street Light**  
Dry Back: 55  
Clic Ac: 55



**1284 Urban Street Medium**  
Dry Back: 55  
Clic Ac: 55



**1565 Urban Street Cream**  
Dry Back: 55  
Clic Ac: 55



**1757 Resin Marble**  
Dry Back: 55

Color scan scale: 1/5



Resin Marble /  
Urban Street Cream

### Backyard

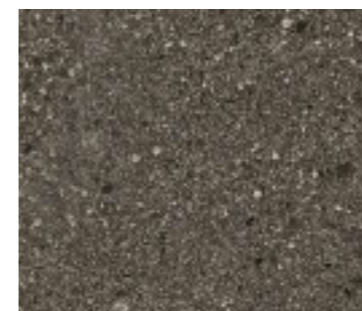

**1711 Backyard Dark**  
Dry Back: 30 / 55  
Clic Ac: 40 / 55



**1713 Backyard Taupe**  
Dry Back: 30 / 55  
Clic Ac: 40 / 55



**1712 Backyard Light Beige**  
Dry Back: 30 / 55  
Clic Ac: 40 / 55

# Creation Tiles & Planks

Creation 30/40/55 - Dry Back / Clic / Clic Acoustic

Formats details on page 132



## Confetti & Urban Street



1745 Confetti Cobalt  
Dry Back: 55  
Clic Ac: 55



1744 Confetti Amber  
Dry Back: 55  
Clic Ac: 55



1726 Urban Street Amber  
Dry Back: 55

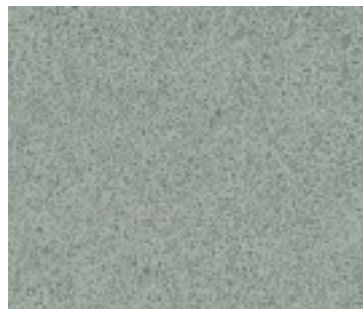

1727 Urban Street Cobalt  
Dry Back: 55

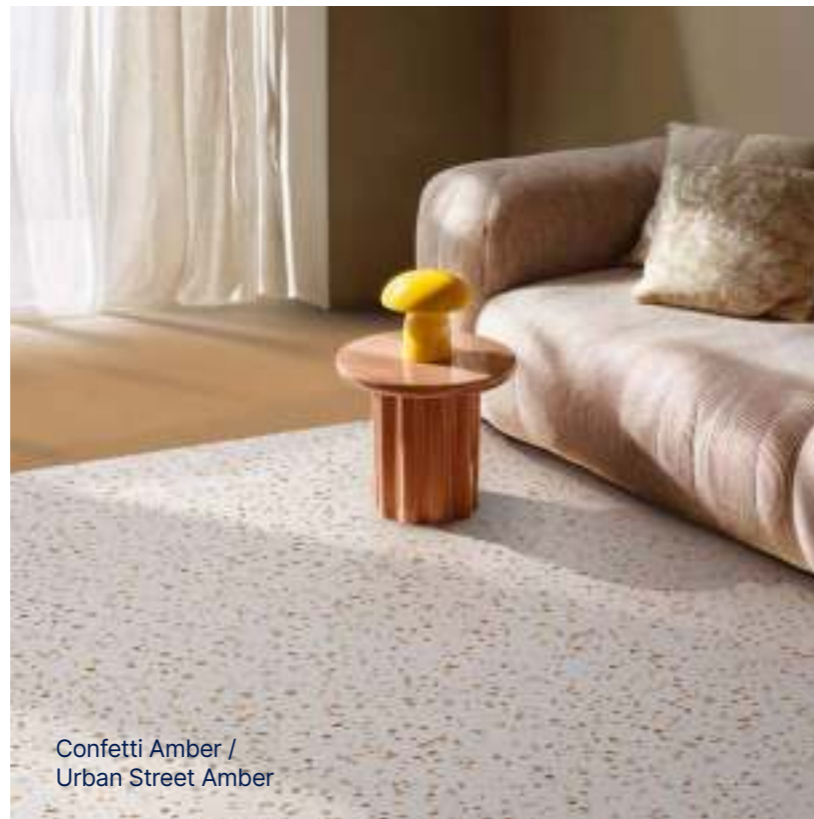

Confetti Amber /  
Urban Street Amber

## Luna



1749 Luna Cobalt  
Dry Back: 55



1748 Luna Beige  
Dry Back: 55



1747 Luna Amber  
Dry Back: 55

Color scan scale: 1/10

122 Design shade variation: Light Medium high

## Marble & Travertin



1729 Paradiso Bone  
Dry Back: 55



1730 Paradiso Cream  
Dry Back: 55



Creation: Paradiso Bone  
Mural Revela: Travertine Bone

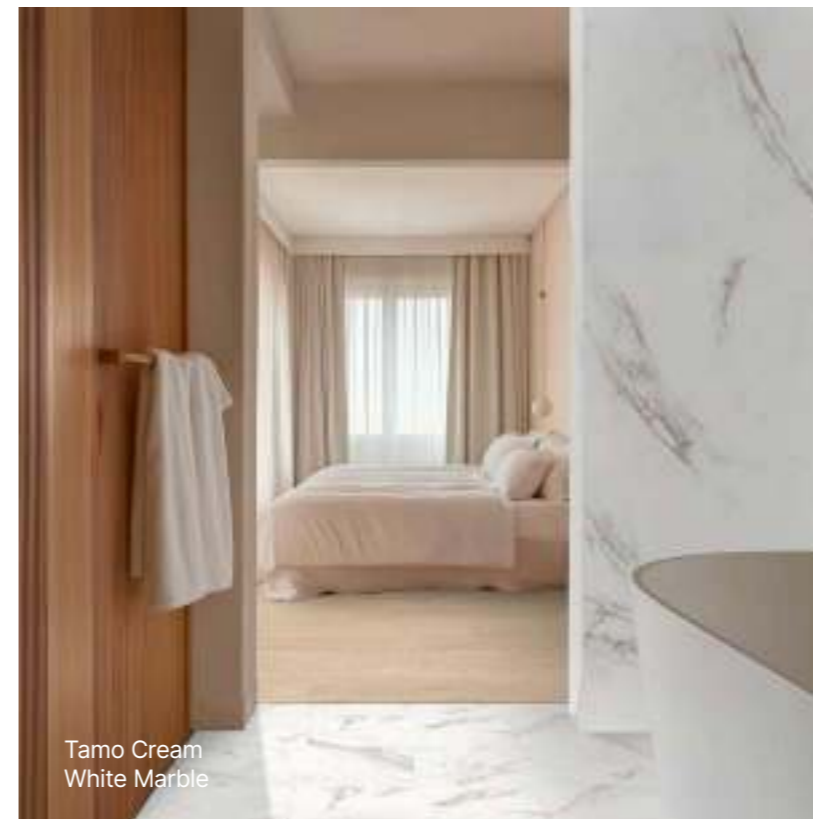

Tamo Cream  
White Marble



1743 White Marble  
Dry Back: 55  
Clic Ac: 55



1742 Sahara Noir  
Dry Back: 55

# Creation Tiles & Planks

## Creation 70 - Dry Back / Clic

### City Oak



1719 City Oak Honey

Dry Back



1717 City Oak Dark Brown

Dry Back Clic



1715 City Oak Beige

Dry Back Clic



City Oak Beige



1716 City Oak Brown

Dry Back

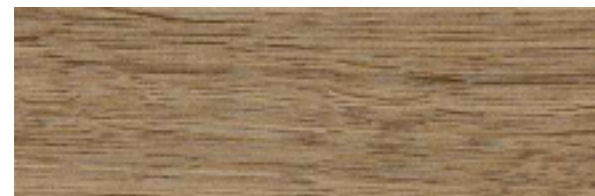

1718 City Oak Grey

Dry Back Clic



### Lounge Oak

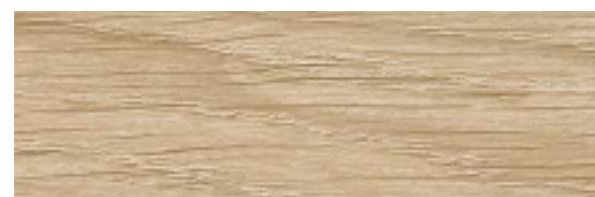

1272 Lounge Oak Beige

Dry Back Clic



1271 Lounge Oak Golden

Dry Back Clic



1273 Lounge Oak Natural

Dry Back Clic



1274 Lounge Oak Chesnut

Dry Back Clic



Formats details on page 132



### Quartet



0870 Quartet Honey

Dry Back Clic



0545 Quartet Natural

Dry Back Clic



0503 Quartet

Dry Back Clic



1597 Quartet Dark Brown

Dry Back Clic

### Cedar

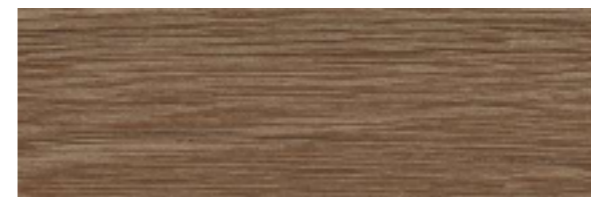

1605 Cedar Dark Brown

Dry Back Clic



1606 Cedar Golden

Dry Back Clic



0850 Cedar Brown

Dry Back Clic



1607 Cedar Natural

Dry Back Clic



Cedar Dark Brown

\*Clic version only for Cedar design



# Creation Tiles & Planks

## Creation 70 - Dry Back / Clic

Formats details on page 132



### Onka



1056 Onka Pearl

Dry Back  
Clic



1721 Onka Greige

Dry Back



1720 Onka Caramel

Dry Back  
Clic



0441 Honey Oak

Dry Back  
Clic



0347 Ballerina

Dry Back  
Clic



0455 Long Board

Dry Back  
Clic



0504 Twist

Dry Back  
Clic



0584 White Lime

Dry Back  
Clic



0456 Ranch

Dry Back  
Clic



0556 Clifton

Dry Back



0577 Albion

Dry Back  
Clic

### Linear Wood



1702 Linear Wood Honey

Dry Back  
Clic



1701 Linear Wood Clear

Dry Back

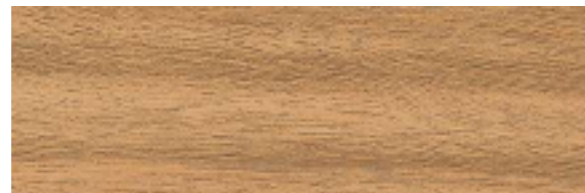

1703 Linear Wood Nature

Dry Back  
Clic



# Creation Tiles & Planks

## Creation 70 - Dry Back / Clic

Formats details on page 132



### Stony & Urban Street



1283 Urban Street Light  
Dry Back / Clic



1284 Urban Street Medium  
Dry Back / Clic



1565 Urban Street Cream  
Dry Back

### Dock & East Village



0087 Dock Taupe  
Dry Back



0085 Dock Grey  
Dry Back



0522 East Village  
Dry Back



1575 Stony Cream  
Dry Back

Color scan scale: 1/4



Urban Street Medium  
Pop



Dock Taupe

### Backyard & Pop

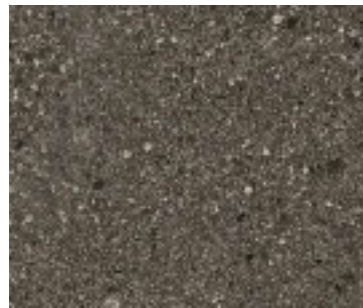

1711 Backyard Dark  
Dry Back / Clic



1713 Backyard Taupe  
Dry Back / Clic



1758 Pop  
Dry Back

Color scan scale: 1/10



1723 Backyard Grey  
Dry Back / Clic



1712 Backyard Light Beige  
Dry Back

### Marble



1722 Marble Black  
Dry Back / Clic



1755 Marble Light Grey  
Dry Back



Marble Black - Marble Light Grey

# Creation Tiles & Planks

Creation 70 - Dry Back / Clic



Formats details on page 132



## Chips & Urban Street



1725 Chips Cobalt  
Dry Back



1724 Chips Amber  
Dry Back



1726 Urban Street Amber  
Dry Back

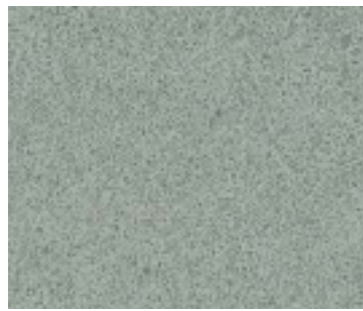

1727 Urban Street Cobalt  
Dry Back



Urban Street Amber - Chips Amber

## Curton Stone



1604 Curton Stone Taupe  
Dry Back / Clic



## Etna

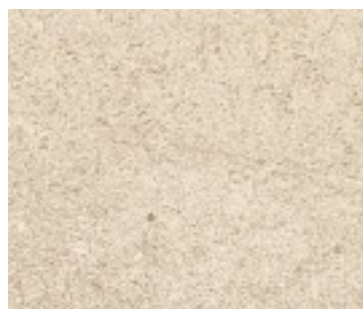

1603 Curton Stone Clear  
Dry Back / Clic



1068 Etna Beige  
Dry Back

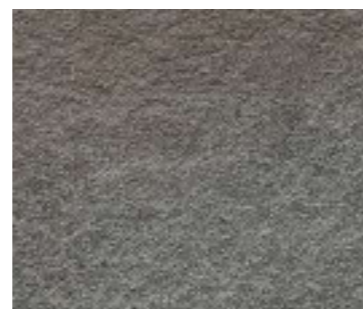

1069 Etna Dark  
Dry Back



## Full Design Concept



PVC Design Skirting  
6086 + Color code  
Cap x10: 60870001



MDF Design Skirting  
5947 + Color code  
Clip x 30: 59480001

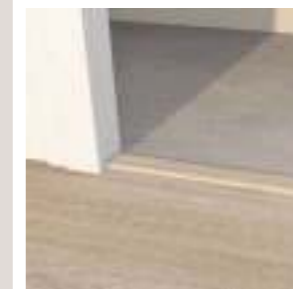

Design Coverstrip  
0642 + Color code

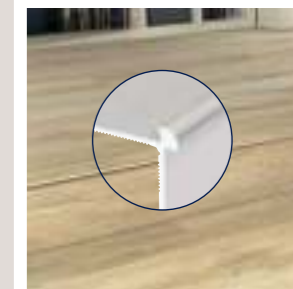

Stair Profile  
E042 0001



Access for all  
Easyplot: 059C0002 Grey  
059C0003 Black / 059D0100 Alu  
Easyguide: E2190006 Black



Transition Profile  
0505 0001

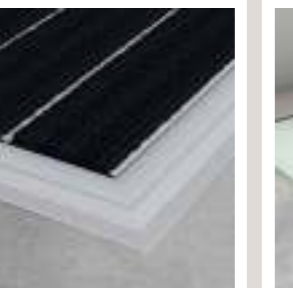

Entrance Mat  
1700 0001 KIT ESPLANADE 9000  
12MM - 1500X1518  
1719 0001 ROMAT GT 12MM- 1500X1000



Acoustic Underlayer  
1698 0001 Smartfix - Creation 30/40/55  
5949 0001 Silence Plus 19dB - Creation 40/55 Clic  
0704 0001 Acoustic Plus 19dB - Creation 40/55/70 Clic  
1798 0001 Acoustic 15dB - Creation 40/55/70 Clic

## Acoustic Underlayers



**Impact sound insulation reduction:**  
Smartfix underlayer +  
Creation 30/40/55 Dry Back: **16 dB**

Silence Plus 19 dB + Creation 40/55 Clic: **19 dB**

Acoustic 15 dB + Creation 40/55/70 Clic: **15 dB**

Acoustic Plus 19 dB + Creation 40/55/70 Clic: **19 dB**

Refer to Gerflor Installation guidelines on gerflor.com



# Creation Tiles & Planks

## Cross references table

Code	Color Design	Creation 30		Creation 40		Creation 55			Creation 70	
		Dry Back	Dry Back	Clic	Clic Acoustic	Dry Back	Clic	Clic Acoustic	Dry Back	Clic
0577	ALBION	-	-	-	-	-	-	-	184x1219	212x1239
1704	AQUINOAH BLOND	184x1219	-	-	212x1239	184x1219 / HB: 152x762 / HP: 133x800	212x1239	212x1239 / HB: 125x750	-	-
1705	AQUINOAH BROWN	184x1219	-	-	212x1239	184x1219	-	212x1239	-	-
1706	AQUINOAH HONEY	184x1219	-	-	212x1239	184x1219 / HB: 152x762 / HP: 133x800	212x1239	212x1239 / HB: 125x750	-	-
1707	AQUINOAH NATURE	184x1219	-	-	212x1239	184x1219 / HB: 152x762	212x1239	212x1239 / HB: 125x750	-	-
1711	BACKYARD DARK	610x610	-	-	389x729	610x610	-	389x729	610x610	389x729
1723	BACKYARD GREY	-	-	-	-	-	-	-	610x610	389x729
1712	BACKYARD LIGHT BEIGE	610x610	-	-	389x729	610x610	-	389x729	610x610	389x729
0347	BALLERINA	610x610	-	-	389x729	610x610	-	389x729	610x610	389x729
1713	BACKYARD TAUPE	610x610	-	-	389x729	610x610	-	389x729	610x610	389x729
0347	BALLERINA	184x1219	184x1219	212x1239	212x1239	184x1219 / HB: 152x762	212x1239	212x1239 / HB: 125x750	184x1219	212x1239
1599	BLOOM UNI CLEAR	457x914	457x914	-	389x729	457x914	389x729	389x729	-	-
1600	BLOOM UNI CREAM	457x914	457x914	-	389x729	457x914	-	389x729	-	-
1601	BLOOM UNI DARK	457x914	457x914	-	389x729	457x914	389x729	389x729	-	-
1602	BLOOM UNI PEARL	457x914	457x914	-	389x729	457x914	389x729	389x729	-	-
0853	BOSTONIAN OAK BEIGE	184x1219	184x1219	-	212x1239	184x1219	-	212x1239	-	-
0851	BOSTONIAN OAK HONEY	184x1219	184x1219	-	212x1239	184x1219	-	212x1239	-	-
0850	CEDAR BROWN	230x1500	230x1500	240x1461	240x1461	230x1500	240x1461	240x1461	230x1500	240x1461
1605	CEDAR DARK BROWN	230x1500	230x1500	240x1461	240x1461	230x1500	240x1461	240x1461	230x1500	240x1461
1606	CEDAR GOLDEN	230x1500	230x1500	240x1461	240x1461	230x1500	240x1461	240x1461	230x1500	240x1461
1607	CEDAR NATURAL	230x1500	230x1500	240x1461	240x1461	230x1500	240x1461	240x1461	230x1500	240x1461
1278	CHARMING OAK BEIGE	184x1219	-	-	-	184x1219	-	212x1239	-	-
1279	CHARMING OAK GREY	184x1219	-	-	-	184x1219	-	212x1239	-	-
1714	CHARMING OAK SMOKED	184x1219	-	-	-	184x1219	-	212x1239	-	-
1724	CHIPS AMBER	-	-	-	-	-	-	-	610x610	-
1725	CHIPS COBALT	-	-	-	-	-	-	-	610x610	-
1715	CITY OAK BEIGE	-	-	-	-	-	-	-	230x1500	240x1461
1716	CITY OAK BROWN	-	-	-	-	-	-	-	230x1500	-
1717	CITY OAK DARK BROWN	-	-	-	-	-	-	-	230x1500	240x1461
1718	CITY OAK GREY	-	-	-	-	-	-	-	230x1500	240x1461
1719	CITY OAK HONEY	-	-	-	-	-	-	-	230x1500	-
0556	CLIFTON	-	-	-	-	-	-	-	184x1219	-
1744	CONFETTI AMBER	-	-	-	-	610x610	-	389x729	-	-
1745	CONFETTI COBALT	-	-	-	-	610x610	-	389x729	-	-
1603	CURTON STONE CLEAR	457x914	457x914	389x729	389x729	457x914	389x729	389x729	457x914	389x729
1604	CURTON STONE TAUPE	457x914	457x914	389x729	389x729	457x914	389x729	389x729	457x914	389x729
0085	DOCK GREY	-	-	-	-	-	-	-	457x914	-
0087	DOCK TAUPE	-	-	-	-	-	-	-	457x914	-
0522	EAST VILLAGE	-	-	-	-	-	-	-	610x610	-
1068	ETNA BEIGE	-	-	-	-	-	-	-	457x914	-
1069	ETNA DARK	-	-	-	-	-	-	-	457x914	-
0441	HONEY OAK	184x1219	184x1219	212x1239	212x1239	184x1219	212x1239	212x1239	184x1219	212x1239
1701	LINEAR WOOD CLEAR	-	-	-	-	184x1219	212x1239	212x1239	184x1219	212x1239
1702	LINEAR WOOD HONEY	-	-	-	-	184x1219	212x1239	212x1239	184x1219	212x1239
1703	LINEAR WOOD NATURAL	-	-	-	-	184x1219	212x1239	212x1239	184x1219	212x1239
0455	LONG BOARD	184x1219	184x1219	212x1239	212x1239	184x1219	212x1239	212x1239	184x1219	212x1239
1272	LOUNGE OAK BEIGE	230x1500	230x1500	240x1461	240x1461	230x1500	240x1461	240x1461	230x1500	240x1461
1274	LOUNGE OAK CHESTNUT	230x1500	230x1500	240x1461	240x1461	230x1500	240x1461	240x1461	230x1500	240x1461
1271	LOUNGE OAK GOLDEN	230x1500	230x1500	240x1461	240x1461	230x1500	240x1461	240x1461	230x1500	240x1461
1273	LOUNGE OAK NATURAL	230x1500	230x1500	240x1461	240x1461	230x1500	240x1461	240x1461	230x1500	240x1461
1747	LUNA AMBER	-	-	-	-	610x610	-	-	-	-
1748	LUNA BEIGE	-	-	-	-	610x610	-	-	-	-
1749	LUNA COBALT	-	-	-	-	610x610	-	-	-	-
1722	MARBLE BLACK	-	-	-	-	-	-	-	914x914	389x729
1755	MARBLE LIGHT GREY	-	-	-	-	-	-	-	914x914	-
1720	ONKA CARAMEL	-	-	-	-	-	-	-	230x1500	240x1461
1721	ONKA GREIGE	-	-	-	-	-	-	-	230x1500	-
1056	ONKA PEARL	-	-	-	-	-	-	-	230x1500	240x1461
1729	PARADISO BONE	-	-	-	-	457x914	-	-	-	-
1730	PARADISO CREAM	-	-	-	-	457x914	-	-	-	-
1758	POP	-	-	-	-	-	-	-	496x996	-
0503	QUARTET	184x1219	184x1219	212x1239	212x1239	184x1219 / HB: 152x762	212x1239	212x1239 / HB: 125x750	184x1219	212x1239
1597	QUARTET DARK BROWN	184x1219	184x1219	212x1239	212x1239	184x1219	212x1239	212x1239	184x1219	212x1239
0870	QUARTET HONEY	184x1219	184x1219	212x1239	212x1239	184x1219	212x1239	212x1239	184x1219	212x1239
0545	QUARTET NATURAL	184x1219	184x1219	212x1239	212x1239	184x1219	212x1239	212x1239	184x1219	212x1239
0456	RANCH	184x1219	184x1219	212x1239	212x1239	184x1219	212x1239	212x1239	184x1219	212x1239
1757	RESIN MARBLE	-	-	-	-	496x996	-	-	-	-
1742	SAHARA NOIR	-	-	-	-	457x914	-	-	-	-
1708	SAVAGE OAK GREIGE	184x1219	-	-	212x1239	184x1219	-	212x1239	-	-
1709	SAVAGE OAK HONEY	184x1219	-	-	212x1239	184x1219	212x1239	212x1239	-	-
1710	SAVAGE OAK SMOKED	184x1219	-	-	212x1239	184x1219	212x1239	212x1239	-	-
1575	STONY CREAM	-	-	-	-	-	-	-	610x610	-
1567	TAMO CLEAR	184x1219	184x1219	-	212x1239	184x1219	-	212x1239	-	-
1598	TAMO CREAM	184x1219	184x1219	-	212x1239	184x1219	-	212x1239	-	-
1568	TAMO LIGHT BROWN	184x1219	184x1219	-	212x1239	184x1219	-	212x1239	-	-
1561	TAMO NATURAL	184x1219	184x1219	-	212x1239	184x1219	-	212x1239	-	-
0504	TWIST	184x1219	184x1219	212x1239	212x1239	184x1219 / HB: 152x762	212x1239	212x1239 / HB: 125x750	184x1219	212x1239
1726	URBAN STREET AMBER	-	-	-	-	610x610	-	-	610x610	-
1727	URBAN STREET COBALT	-	-	-	-	610x610	-	-	610x610	-
1565	URBAN STREET CREAM	-	-	-	-	610x610	389x729	389x729	610x610	-
1283	URBAN STREET LIGHT	-	-	-	-	914x914	-	389x729	914x914	389x729
1284	URBAN STREET MEDIUM	-	-	-	-	914x914	-	389x729	914x914	389x729
1751	VERSAILLES BLOND	-	-	-	-	610x610	-	-	-	-
1750	VERSAILLES HONEY	-	-	-	-	610x610	-	-	-	-
0584	WHITE LIME	184x1219	184x1219	212x1239	212x1239	184x1219	212x1239	212x1239	184x1219	212x1239
1743	WHITE MARBLE	-	-	-	-	457x914	-	389x729	-	-

Code	Color Design	PVC Design Skirting	MDF Design Skirting	Design Coverstrip	Shade Variation	Emboss	NCS	LRV
0577	ALBION	6086S001	5947S001	0642C000	Medium	SCANDINAVIAN	4020-Y30R	21.8
1704	AQUINOAH BLOND	6086S001	5947S001	0642C002	Light	SCANDINAVIAN*	3020-Y20R	34.2
1705	AQUINOAH BROWN	6086S001	5947S001	0642C000	Light	SCANDINAVIAN	6020-Y20R	16.9
1706	AQUINOAH HONEY	6086S001	5947S001	0642C003	Light	SCANDINAVIAN*	4030-Y20R	22.7
1707	AQUINOAH NATURE	6086S201	5947S201	0642C000	Light	SCANDINAVIAN*	5010-Y10R	26.9
1711	BACKYARD DARK	6086S001	5947S001	0642C015	Light	HAMMERED	6502-Y	13.7
1723	BACKYARD GREY	6086S001	5947S001	0642C000	Light	HAMMERED	3502-Y	36.0
1712	BACKYARD LIGHT BEIGE	6086S001	5947S001	0642C000	Light	HAMMERED	3005-Y20R	46.0
1713	BACKYARD TAUPE	6086S001	5947S001	0642C019	Light	HAMMERED	4005-Y20R	33.3
0347	BALLERINA	6086S008	5947S008	0642C008	Light	SCANDINAVIAN*	4040-Y20R	28.4
1599	BLOOM UNI CLEAR	6086S094	5947S094	0642C017	Light	HAMMERED	3500-N	38.2
1600	BLOOM UNI CREAM	6086S204	5947S204	0642C020	Light	HAMMERED	2002-Y30R	49.2
1601	BLOOM UNI DARK	6086S092	5947S092	0642C015	Light	HAMMERED	7500-N	10.9
1602	BLOOM UNI PEARL	6086S096	5947S096	0642C016	Light	HAMMERED	4502-B	26.9
0853	BOSTONIAN OAK BEIGE	6086S017	5947S017	0642C013	Medium	SCANDINAVIAN	4005-Y20R	36.7
0851	BOSTONIAN OAK HONEY	6086S019	5947S019	0642C006	Medium	SCANDINAVIAN	4020-Y20R	29.8
0850	CEDAR BROWN	6086S024	5947S024	0642C001	Medium	SCANDINAVIAN	5020-Y20R	21.3
1605								

Structure your spaces,  
create harmony



Chips Green / Tamo Light / Marble Dark



# Creation Looselay

Creation  
Tiles & Planks

**52** designs

**6** sizes

**100%** design harmony

Discover the quality and expertise of Gerflor in this collection designed to perfectly combine colours, patterns and formats.

The most comprehensive Looselay range

Creation 55 Looselay  
Creation 55 Looselay Acoustic  
Creation 70 Looselay  
Creation Saga<sup>2</sup>

Multi-formats



A dedicated collection for hospitality, offices, commercial areas, and retail stores

Full design concept

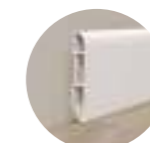

Skirtings  
Plinthes

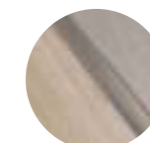

Profiles  
Profilsés

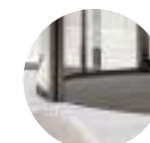

Mats  
Tapis



Wall - Mural  
Revela

EASY TO MATCH WITH GERFLOR  
CARPET COLLECTIONS

# Creation Tiles & Planks

## Creation 55/70 Looselay



### The fastest to install!

- No adhesive, no clic
- No down time - Direct use after installation



### The easiest to mix!

- Easy herringbone installation
- Square format  
Easy mix & match



### The most durable!

- Reinforced structure with fiber glass veil
- Easy replacement



### All the benefits of Looselay engineered by Gerflor

- Renovation on ceramic
- Compatible with raised access floors
- Acoustic comfort (walking noise < 73 dB)



### Designed by Gerflor

- High definition design
- Ultra realistic surface
- 4 bevelled edges
- 52 designs to be mixed



① Exclusive ProtecShield™ surface treatment

② 4D Design

③ Duocore Technology

④ Grip-wave backlayer  
Anti-slip backing

⑤ Creation 55 Looselay Acoustic  
Integrated acoustic underlay  
Sound insulation 19 dB

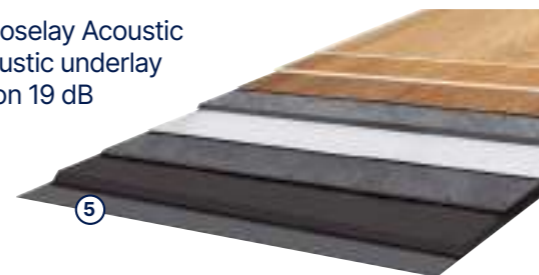

## Creation 55 Looselay

**Creation 55 Looselay** is a synthetic, decorative, flexible, antistatic, abrasion group T floorcovering available in tiles and planks. It consists in a 0.55 mm thick transparent wear layer, a design film and a Duo Core Technology, made with a rigid core back layer reinforced with a fiber veil, combined with a flexible core top layer to provide softness and comfort surface. The overall thickness is 4.5 mm. It also includes anti-skid backing to allow an easy installation and a glue-free installation up to 30 sqm. It benefits from a cross-linked polyurethane surface treatment (**Protecshield™**), making maintenance easier and eliminating the need for initial polishes.

**Creation 55 Looselay** is a looselay floorcovering, resistant to use (commercial / industrial use) of 33-42 according to EN-ISO 10874 and has Bfl-s1 class for smoke emission according to EN 13501-1.

**Creation 55 Looselay** is made with phthalate free plasticizers, except recycled content. It is 100% recyclable and made with 35% of recycled content. It is REACH compliant. **The product emission rate of organic compounds is < 10 microgram/m³** (TVOC < 28 days – ISO 16000-6).

## Creation 55 Looselay Acoustic

**Creation 55 Looselay Acoustic** is a synthetic, decorative, flexible, antistatic, abrasion group T floorcoverings available in tiles and planks with bevelled edges. It consists in a 0.55 mm thick transparent wear layer, a design film and a Duo Core Technology, made with a rigid core back layer reinforced with a fiber veil, combined with a flexible core top layer to provide softness and comfort surface. The backing integrates an acoustic core reaching 19 dB acoustic impact noise reduction. The overall thickness is 5.5 mm. They benefit from a cross-linked polyurethane surface treatment (**Protecshield™**), making maintenance easier and

eliminating the need for initial polishes.

**Creation 55 Looselay Acoustic** is a looselay floorcovering, resistant to use (commercial / industrial use) of 33-42 according to EN-ISO 10874 and has Bfl-s1 class for smoke emission according to EN 13501-1.

**Creation 55 Looselay Acoustic** is made with phthalate free plasticizers, except recycled content. It is 100% recyclable and made with 35% of recycled content. It is REACH compliant. **The product emission rate of organic compounds is < 10 microgram/m³** (TVOC < 28 days – ISO 16000-6).

## Creation 70 Looselay

**Creation 70 Looselay** is a synthetic, decorative, flexible, antistatic, abrasion group T floorcovering available in tiles and planks, with bevelled edges. It consists in a 0.70 mm thick transparent wear layer, a design film and a Duo Core Technology, made with a rigid core back layer reinforced with a fiber veil, combined with a flexible core top layer to provide softness and comfort surface. The overall thickness is 6 mm. It also includes anti-skid backing to allow an easy installation. It benefits from a cross-linked polyurethane surface treatment (**PUR+ Matt**), making maintenance easier and eliminating the need for initial polishes.

**Creation 70 Looselay** is a looselay floorcovering, resistant to use (commercial / industrial use) of 34-43 according to EN-ISO 10874 and has Bfl-s1 class for smoke emission according to EN 13501-1.

**Creation 70 Looselay** is made with phthalate free plasticizers, except recycled content. It is 100% recyclable and made with 35% of recycled content. It is REACH compliant.

**The product emission rate of organic compounds is < 10 microgram/m³** (TVOC < 28 days – ISO 16000-6).

## Sustainability & comfort in one product!



**100% recyclable through Gerflor's Second Life Program**  
Up to 35% recycled content



**Great indoor air quality**  
TVOC emissions  
<10 micrograms/m³ after 28 days



**Reach compliant**



**Carbon footprint**  
EPD available



**Adhesive Free Installation**  
Up to 30 sqm



**Easy to remove**  
Easy to re-use

For more information, please refer to Gerflor installation guidelines.

# Creation Tiles & Planks

## Creation 55 - Looselay / Looselay Acoustic

Chevrons 



1561 Tamo Natural / 1567 Tamo Clear /  
1568 Tamo Light Brown



Formats details  
on page 149



### Tamo



1559 Tamo Light

Looselay  
Looselay Ac



1561 Tamo Natural

Looselay  
Looselay Ac



1560 Tamo Dainty

Looselay  
Looselay Ac



1568 Tamo Light Brown

Looselay



1567 Tamo Clear

Looselay



Tamo Dainty



# Creation Tiles & Planks

## Creation 55 - Looselay / Looselay Acoustic

Formats details on page 149



0455 Long Board

Looselay  
Looselay Ac



0441 Honey Oak

Looselay



0347 Ballerina

Looselay  
Looselay Ac



0456 Ranch

Looselay  
Looselay Ac



0504 Twist

Looselay



0796 Swiss Oak Golden

Looselay



Twist & Swiss Oak Golden

### Urban Street



1565 Urban Street Cream  
Looselay

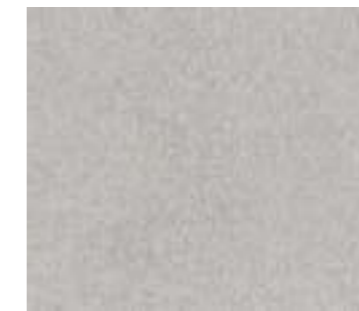

Urban Street Light 1283  
Looselay  
Looselay Ac



1284 Urban Street Medium  
Looselay  
Looselay Ac

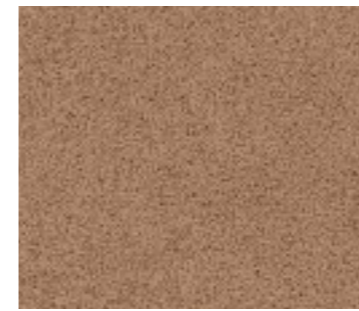

1566 Urban Street Terra  
Looselay



Urban Street Terra / Gentleman Terra

# Creation Tiles & Planks

## Creation 55 - Looselay / Looselay Acoustic



Formats details on page 149



### Gentleman Grey

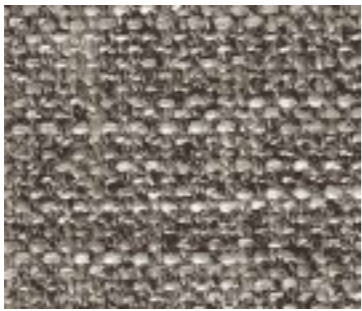

1083 Gentleman Taupe  
Looselay



1563 Gentleman Cream  
Looselay



1564 Gentleman Terra  
Looselay

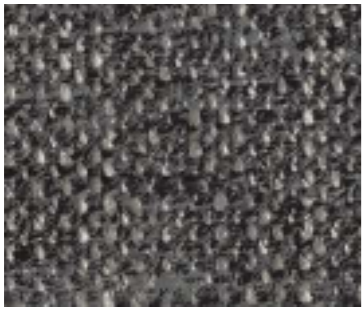

1058 Gentleman Grey  
Looselay



Gentleman Grey /  
Urban Street Light



0374 Parker Station  
Looselay



0436 Riverside  
Looselay

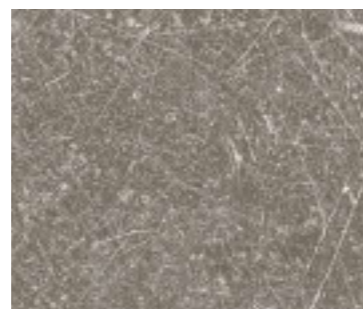

0087 Dock Taupe  
Looselay



0868 Bloom Uni Taupe  
Looselay

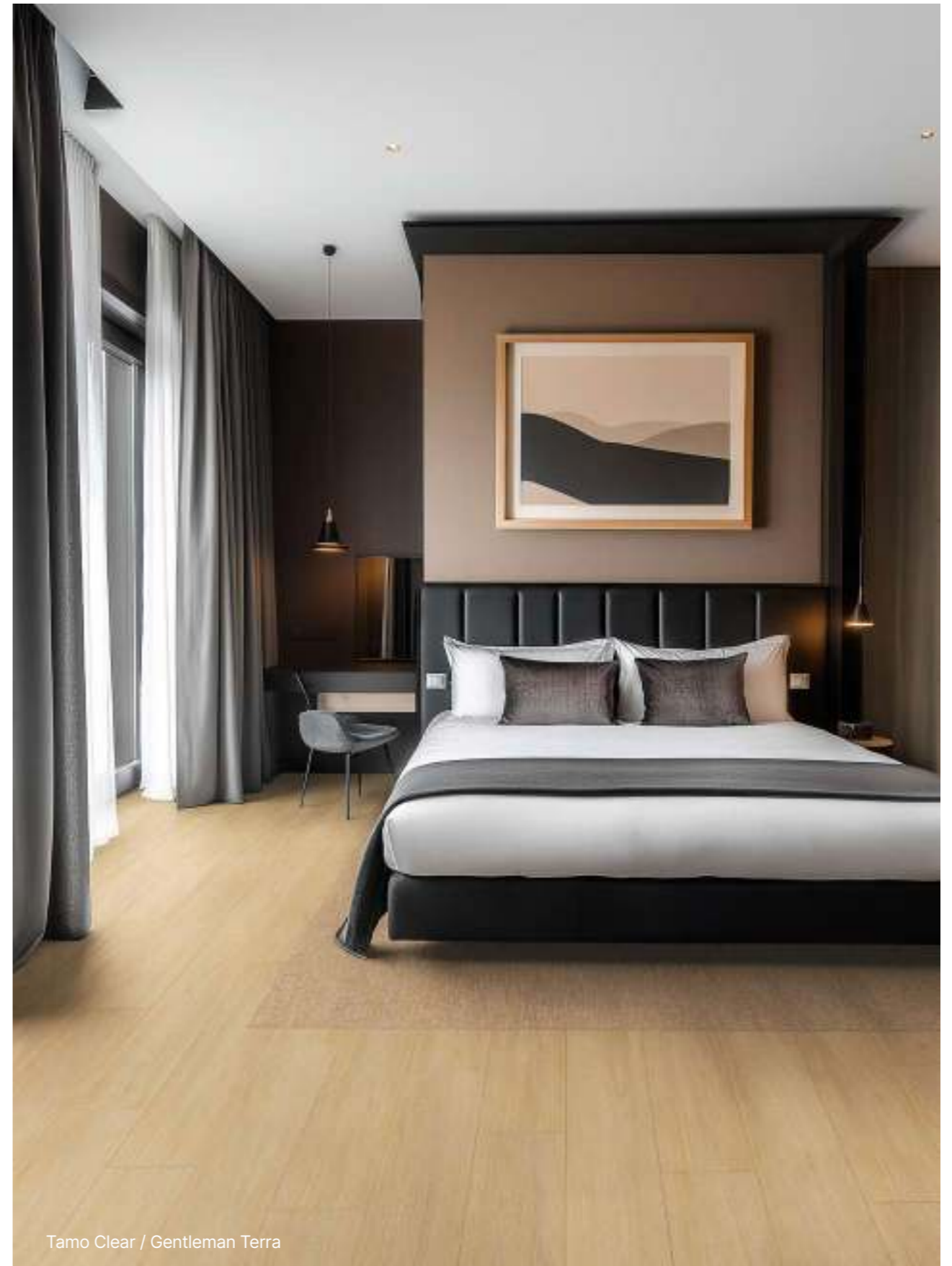

Tamo Clear / Gentleman Terra

# Creation Tiles & Planks

## Creation 70 Looselay

Chevrons 



 Formats details on page 149



### Tamo



1559 Tamo Light

Looselay 

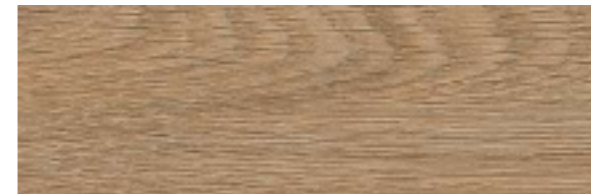

1560 Tamo Dainty

Looselay 



1567 Tamo Clear

Looselay 

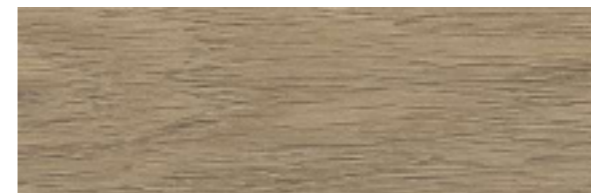

1561 Tamo Natural

Looselay 



1568 Tamo Light Brown

Looselay 

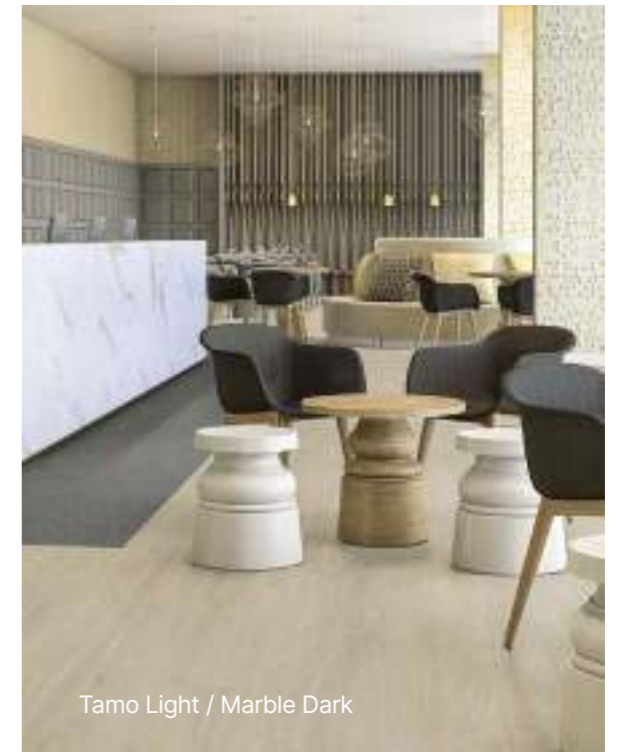

### Namou



1578 Namou Light Honey

Looselay 



1579 Namou Honey

Looselay 



1580 Namou Dark Honey

Looselay 

# Creation Tiles & Planks

## Creation 70 Looselay

Formats details on page 149



0060 Arena

Looselay



0504 Twist

Looselay



0456 Ranch

Looselay



0455 Long Board

Looselay



### Chips



1574 Chips Terra  
Looselay



1573 Chips Green  
Looselay



1572 Chips Blue  
Looselay



Marble Green / Chips Green

### Urban Street

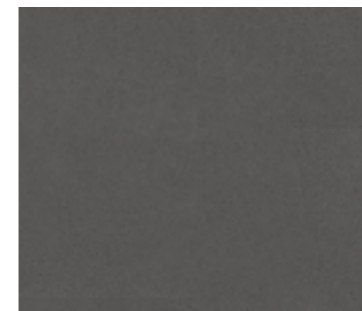

1577 Urban Street Dark  
Looselay

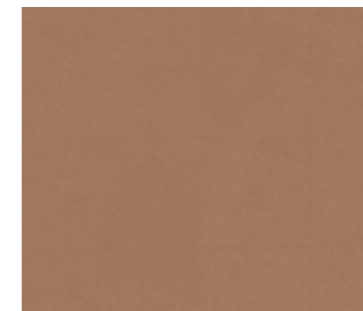

1566 Urban Street Terra  
Looselay

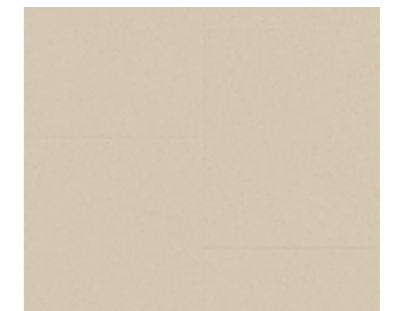

1565 Urban Street Cream  
Looselay



1284 Urban Street Medium  
Looselay

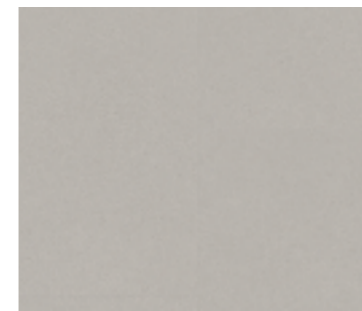

1283 Urban Street Light  
Looselay



Stony Cream /  
Urban Street Cream

### Stony



1576 Stony Medium  
Looselay



1575 Stony Cream  
Looselay



# Creation Tiles & Planks

## Creation 70 Looselay



Formats details on page 149



### Marble

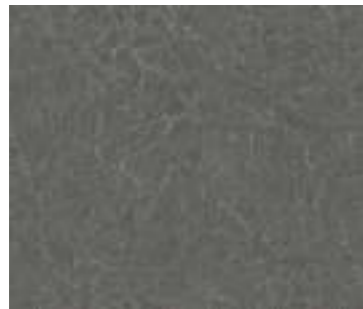

1570 Marble Dark Looselay



0085 Dock Grey Looselay



1569 Marble Clear Looselay



1571 Marble Green Looselay



Marble Dark / Marble Clear

	Creation 55 Looselay	Creation 55 Looselay Acoustic	Creation 70 Looselay	Skirting Matching Design	Coverstrip Matching Design	Emboss	NCS	LRV
<b>Code Color Design</b>								
0060 Arena	-	-	229x1220	S026	-	Natural	4005-Y20R	37,2
0347 Ballerina	229 x 1220	229 x 1220	-	S008	C008	Natural	4040-Y20R	28,4
0868 Bloom Uni Taupe	600 x 600	-	-	S072	C019	Hammered	4502-Y	28,5
1572 Chips Blue	-	-	600x600	-	-	Hammered	1502-B	62,5
1573 Chips Green	-	-	600x600	-	-	Hammered	1502-G	53,2
1574 Chips Terra	-	-	600x600	-	-	Hammered	1502-Y	64,6
0085 Dock Grey	-	-	914x914	S111	C015	Hammered	6500-N	20,1
0087 Dock Taupe	914 x 914	-	-	S020	C019	Hammered	6005-Y50R	19,2
1563 Gentleman Cream	600 x 600 152 x 914	-	-	-	-	Textile	3010-Y40R	40,1
1058 Gentleman Grey	600 x 600 152 x 914	-	-	-	-	Textile	7500-N	12,7
1083 Gentleman Taupe	600 x 600	-	-	-	-	Textile	5502-Y	21,2
1564 Gentleman Terra	600 x 600	-	-	-	-	Textile	4020-Y30R	27
0441 Honey Oak	229 x 1220	-	-	S033	C006	Natural	4020-Y20R	27,7
0455 Long Board	229 x 1220	229 x 1220	229x1220	S034	C006	Brushed	4010-Y30R	24,8
1569 Marble Clear	-	-	914x914 / 152x914	-	-	Hammered	2000-N	53,8
1570 Marble Dark	-	-	914x914 / 152x914	-	-	Hammered	7502-R	13,9
1571 Marble Green	-	-	914x914	-	-	Hammered	5010-G10Y	24,6
1580 Namou Dark Honey	-	-	235x1505	S008	-	Natural	4030-Y20R	23,5
1579 Namou Honey	-	-	235x1505	S058	-	Natural	4020-Y20R	33,6
1578 Namou Light Honey	-	-	235x1505	S019	C006	Natural	3020-Y20R	34,5
0374 Parker Station	914 x 914	-	-	S047	C023	Hammered	8000-N	12,6
0456 Ranch	229 x 1220	229 x 1220	229x1220	S053	C014	Brushed	5005-Y50R	23,5
0436 Riverside	600 x 600	-	-	S032	-	Hammered	6502-Y	16,7
1575 Stony Cream	-	-	600x600	-	-	Hammered	3502-Y	35,8
1576 Stony Medium	-	-	600x600	-	-	Hammered	3502-B	38,1
0796 Swiss Oak Golden	229 x 1220	-	-	S015	C003	Natural	4030-Y20R	25,8
1567 Tamo Clear	229 x 1220 152 x 914	-	229x1220 / 152x914	S168	C006	Natural	3020-Y20R	33,3
1560 Tamo Dainty	229 x 1220	229 x 1220	229x1220	-	-	Natural	4020-Y30R	24
1559 Tamo Light	229 x 1220 152 x 914	229 x 1220	229x1220 / 152x914	S188	C005	Natural	3010-Y20R	36,6
1568 Tamo Light Brown	229 x 1220 152 x 914	-	229x1220 / 152x914	S202	C003	Natural	5020-Y30R	17,2
1561 Tamo Natural	229 x 1220	229 x 1220	229x1220	S016	C004	Natural	4020-Y20R	24,4
0504 Twist	229 x 1220	-	229x1220	S039	C011	Natural	3010-Y30R	38,9
1565 Urban Street Cream	600 x 600	-	600x600	-	-	Hammered	2005-Y20R	50
1577 Urban Street Dark	-	-	914x914	-	-	Hammered	7500-N	11,1
1283 Urban Street Light	914 x 914	600 x 600	914x914	S094	-	Hammered	3000-N	42,3
1284 Urban Street Medium	914 x 914	600 x 600	914x914	S180	C016	Hammered	4502-R	26,5
1566 Urban Street Terra	600 x 600	-	600x600	-	-	Hammered	5020-Y50R	21,6

S001: White S001: Aluminium

### Packaging

Format (mm)	m <sup>2</sup> /box	m <sup>2</sup> /palett
<b>Creation 55 Looselay</b>		
229 x 1220	1,67	113,6
152 x 914	1,67	110,2
600 x 600	2,16	103,7
914 x 914	3,34	116,9
<b>Creation 55 Looselay Acoustic</b>		
229x1220	2,23	124,9
600x600	2,16	103,7
<b>Creation 70 Looselay</b>		
229 x 1220	1,67	100,2
152 x 914	1,67	100,2
235 x 1505	1,41	95,9
600 x 600	1,44	83,5
914 x 914	3,34	100,2

### Exclusive embosses

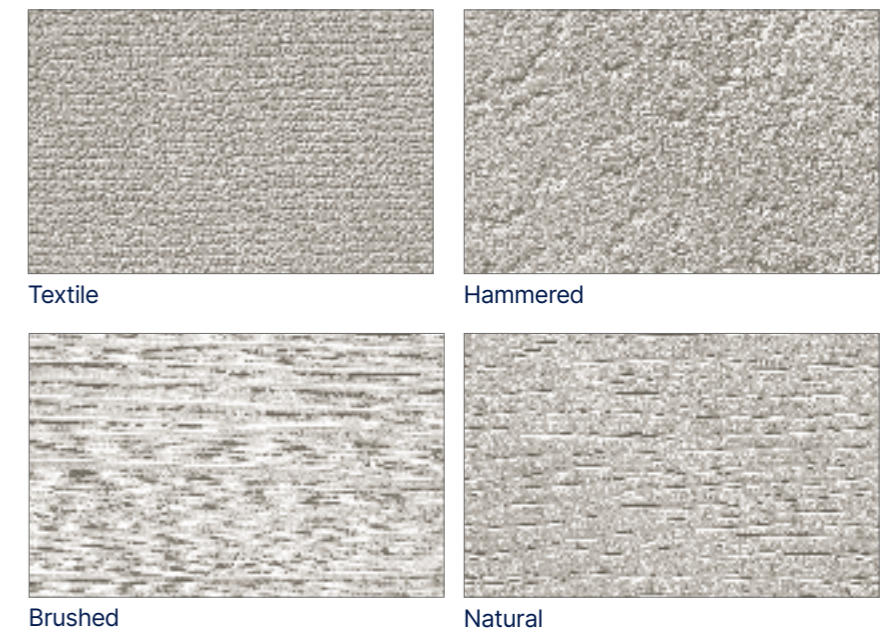

# Creation Tiles & Planks

Creation Saga<sup>2</sup>  
Eco-design "made in Europe"



**71%** Natural, mineral & recycled content



**100% recyclable through Gerflor's Second Life Program**

Up to 35% recycled content



**100% Made in Europe**



**Carbon footprint EPD available**

**70%** Content coming from France



**Easy to remove  
Easy to re-use**

## Cork: performance by nature



**Natural & rapidly renewable (7 years)**



**Strong indentation resistance**



**Natural acoustic properties**  
(15dB insulation & walking noise <65dB)

15 dB



<65 dB

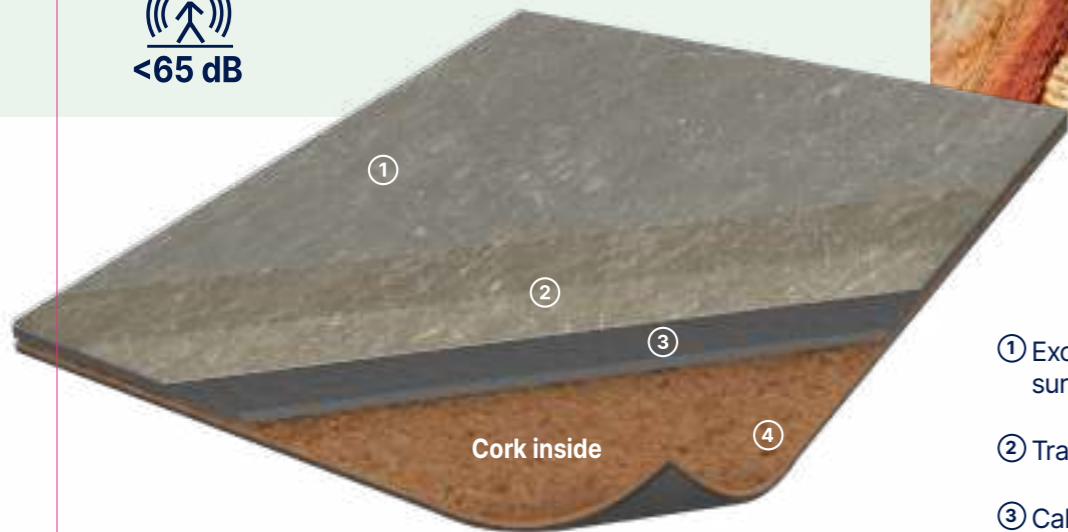

① Exclusive ProtecShield™ surface treatment

② Transparent 0.7 mm wearlayer

③ Calendered interlay

④ Cork + PVC underlayment

## Creation Saga<sup>2</sup>

**SAGA<sup>2</sup>** is a synthetic, decorative, flexible, antistatic, abrasion group T floorcoverings available in tiles and planks. It consists in a 0,70 mm thick transparent wear layer, a design film and an exclusive double calandered layer which integrated cork particles. The overall thickness is 4.6 mm. The cork particles bring a natural acoustic insulation of 15dB and walking noise <65dB.

It benefits from a cross-linked polyurethane surface treatment (**Protecshield™**), making maintenance easier and eliminating the need for initial polishes.

**SAGA<sup>2</sup>** is a looselay floorcovering, resistant to use (commercial / industrial use) of 34 / 43 according to EN-ISO 10874 and has Bfl-s1 class for smoke emission according to EN 13501-1.

**SAGA<sup>2</sup>** is made with phthalate free plasticizers, except recycled content. It is 100% recyclable and have up to 35% of recycled content. It is REACH compliant. **The product emission rate of organic compounds is < 10µg/m<sup>3</sup> (TVOC <28 days – ISO 16000-6).**



Gentlemen Cream / Tamo Dainty

For more information, please refer to Gerflor installation guidelines.

# Creation Tiles & Planks

## Creation Saga<sup>2</sup>

500 x 500 mm **Protecshield™**



### Tweed



1587 Tweed Medium Beige



1584 Tweed Chine Amande



1585 Tweed Green Chine



1588 Tweed Rose Ancien



1586 Tweed Light Grey



### Oxyd Light



1610 Oxyd Light Grey



1608 Oxyd Light Beige



1609 Oxyd Light Green

### Gentleman



0088 Gentleman Grey



1582 Gentleman Jean Chine



0030 Gentleman Blue



0089 Gentleman Taupe



1564 Gentleman Terra



1563 Gentleman Cream



1581 Gentleman Abricot



Scale: 1/5<sup>th</sup>

# Creation Tiles & Planks

Creation Saga<sup>2</sup>



## Urban Street



1566 Urban Street Terra

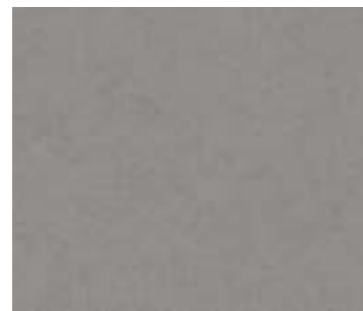

1284 Urban Street Medium

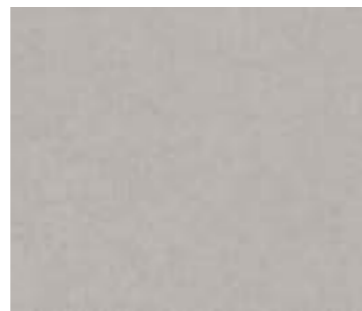

1283 Urban Street Light



1565 Urban Street Cream



Tamo Light

## Tamo



1559 Tamo Light



1567 Tamo Clear



1560 Tamo Dainty



1561 Tamo Natural



Scale: 1/5<sup>th</sup>

154 Design shade variation: Light Medium high

Code	Color Design	Skirting Matching Design	Emboss	NCS	LRV
1581	Gentleman Abricot	S001	Textile	4030-Y40R	23,5
0030	Gentleman Blue	S001	Textile	8010-R70B	8,7
1563	Gentleman Cream	S001	Textile	3010-Y40R	40,1
0088	Gentleman Grey	S001	Textile	7500-N	12,7
1582	Gentleman Jean Chine	S001	Textile	6005-B20G	22,8
0089	Gentleman Taupe	S001	Textile	5502-Y	21,2
1564	Gentleman Terra	S001	Textile	4020-Y30R	27,0
1608	Oxyd Light Beige	S001	Textile	4502-Y	30
1609	Oxyd Light Green	S001	Textile	4020-B50G	24,2
1610	Oxyd Light Grey	S001	Textile	-	-
1567	Tamo Clear	S001	Natural	3020-Y20R	33,3
1560	Tamo Dainty	S001	Natural	4020-Y30R	24,0
1559	Tamo Light	S001	Natural	3010-Y20R	36,6
1561	Tamo Natural	S001	Natural	4020-Y20R	24,4
1584	Tweed Chine Amande	S001	Textile	5010-G10Y	27,8
1585	Tweed Jean Chine	S001	Textile	-	-
1586	Tweed Light Grey	S001	Textile	4502-B	29,3
1587	Tweed Medium Beige	S001	Textile	-	-
1588	Tweed Rose Ancien	S001	Textile	4010-Y90R	31,9
1565	Urban Street Cream	S178	Hammered	2005-Y20R	50,0
1283	Urban Street Light	S094	Hammered	3500-N	39,1
1284	Urban Street Medium	S180	Hammered	4502-B	28,4
1566	Urban Street Terra	S001	Hammered	5020-Y50R	21,6
1284	Urban Street Medium	S180	Hammered	4502-R	26,5
1566	Urban Street Terra	S001	Hammered	5020-Y50R	21,6

S001: White

## Packaging

Format (mm)	m <sup>2</sup> /box	m <sup>2</sup> /palett
500 × 500	2,5	110

## Exclusive embosses



Natural



Hammered



Textile

# Creation Tiles & Planks

## Creation 70 Connect



 Interlocking installation with dovetails

 Fast and easy renovation

 Adhesive free

 All over effect



- ① PUR+ Matte surface treatment
- ② 4D Design
- ③ Resilient reinforced core
- ④ Exclusive patented dovetails



Oak Golden

## Creation 70 Connect

**Creation 70 Connect** is a synthetic, decorative, flexible, antistatic, abrasion group T floorcovering available in tiles. It consists in a 0.70 mm thick transparent wear layer, a design film, a calendered layer and a PVC compact sublayer reinforced with fibers. The overall thickness is 5 mm. It benefits from a cross-linked polyurethane surface treatment (**PUR+ Matt**), making maintenance easier and eliminating the need for initial polishes.

**Creation 70 Connect** is an interlocking floorcovering, resistant to use (commercial / industrial use of 34-43 according to EN-ISO 10874 and has Bfl-s1 class for smoke emission according to EN 13501-1. **Creation 70 Connect** is made with phthalate free plasticizers, except recycled content. It is 100% recyclable and made with 55% of recycled content. It is REACH compliant. **The product emission rate of organic compounds is < 10 microgram/m³ (TVOC < 28 days – ISO 16000-6).**



Gentleman Taupe / Dalma Grey



**Entrance mats / Tapis d'entrée**  
**Kit Romat GT 1719**  
1500x1000 mm



**Aluminium Profile 0505**  
(Corner 1513)



**Anti Bounce Mallet / Maillet anti-rebond 5951**

# Creation Tiles & Planks

## Creation 70 Connect

 PUR+ Matt  
701,3 x 701,3 mm



### Gentleman



1083 Gentleman Taupe

### Rough Textile



0063 Rough Textile Grey

### Oak



0090 Oak Light



1058 Gentleman Grey



0062 Rough Textile Beige



1492 Oak Golden

### Dock



0085 Dock Grey

### Dalma

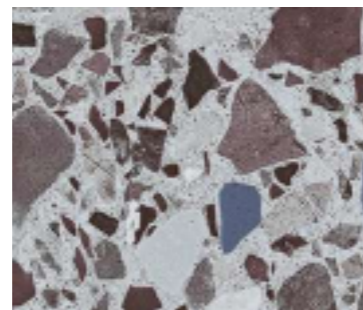

1089 Dalma Burgundy



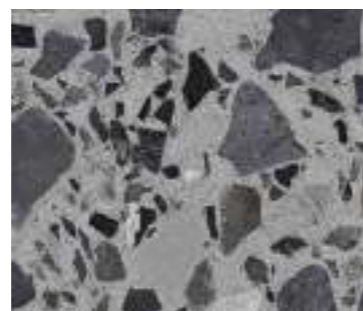

0087 Dock Taupe



1088 Dalma Grey



0091 OSB Natural

	Connect	Skirting Matching Design	Emboss	NCS	LRV
Code Color Design					
0085 Dock Grey	701,3x701,3	S111	Hammered	6500-N	201
0087 Dock Taupe	701,3x701,3	S020	Hammered	6005-Y50R	19.2
1058 Gentleman Grey	701,3x701,3	S001	Textile	7500-N	12.7
1083 Gentleman Taupe	701,3x701,3	S001	Textile	5502-Y	21.2
1089 Dalma Burgundy	701,3x701,3	S001	Hammered	6005-Y80R	24.7
1088 Dalma Grey	701,3x701,3	S001	Hammered	7005-R80B	19
1492 Oak Golden	701,3x701,3	S001	Natural	4020-Y30R	27.9
0090 Oak Light	701,3x701,3	S001	Natural	5500-N	211
0091 OSB Natural	701,3x701,3	S001	Hammered	2010-Y40R	41.6
0062 Rough Textile Beige	701,3x701,3	S001	Textile	5005-Y20R	25.4
0063 Rough Textile Grey	701,3x701,3	S001	Textile	5500-N	211

└ S001: White ─┘

### Packaging

Format (mm)	m <sup>2</sup> /box	m <sup>2</sup> /palett
Creation 70 Connect		
701,3 x 701,3	-	49,14

### Exclusive embosses



Natural

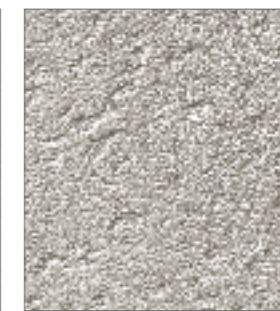

Hammered



Textile



OSB Natural

# Creation Tiles & Planks

Creation 70 MegaClic **New**



## New design collection

 **Inspired by the latest Interior Design Trends for Commercial Spaces**

 **Designed to combine with GTI® or Design Tile and reach perfect harmony**

## Patented by Gerflor

 **Patented double vertical clic specifically designed for high traffic environments**

 **Rolling traffic compliant\* up to 700kg**

## Designed for Comfort & Safety

 **Noise reduction vs ceramic**  
Acoustic comfort

 **R10**  
Slip resistance

 **ProtecShield™ surface treatment**  
Easy cleaning

 **Adhesive free installation\***

 **Renovation over ceramic**

 **Easy to replace**

- ① ProtecShield® High Performance Surface Treatment
- ② Ultrarealistic & Embossed Wear Layer
- ③ Smart Design Expanded pattern variation → Authentic, natural look
- ④ Resilient reinforced core
- ⑤ Patented double vertical clic



## Creation 70 MegaClic

**Creation 70 MegaClic** is a synthetic, decorative, flexible, antistatic, abrasion group T floor coverings available in tiles and planks, with beveled edges. It consists of a 0,70 mm thick transparent wear layer, a design film and reinforced with glass fiber particles, combined with a flexible core top layer to provide softness and comfort surface. The overall thickness is 6 mm. They benefit from a cross-linked polyurethane surface treatment (ProtecShield™), making maintenance easier and eliminating the need for initial polishes.

**Creation 70 MegaClic** is an interlocking floor covering assembled with a double vertical clic on the long and short side for a quick and solid installation. The resistance to use (commercial / industrial use) of 34 / 43 according to EN-ISO 10874 and has Bfl-s1 class for smoke emission according to EN 13501-1. **Creation 70 MegaClic** is made with phthalate free plasticizers, except recycled content. It is 100% recyclable and made with 29% recycled content. It is REACH compliant. The product emission rate of organic compounds is <math>< 10\mu\text{g}/\text{m}^3</math> (TVOC <math>< 28</math> days – ISO 16000-6).

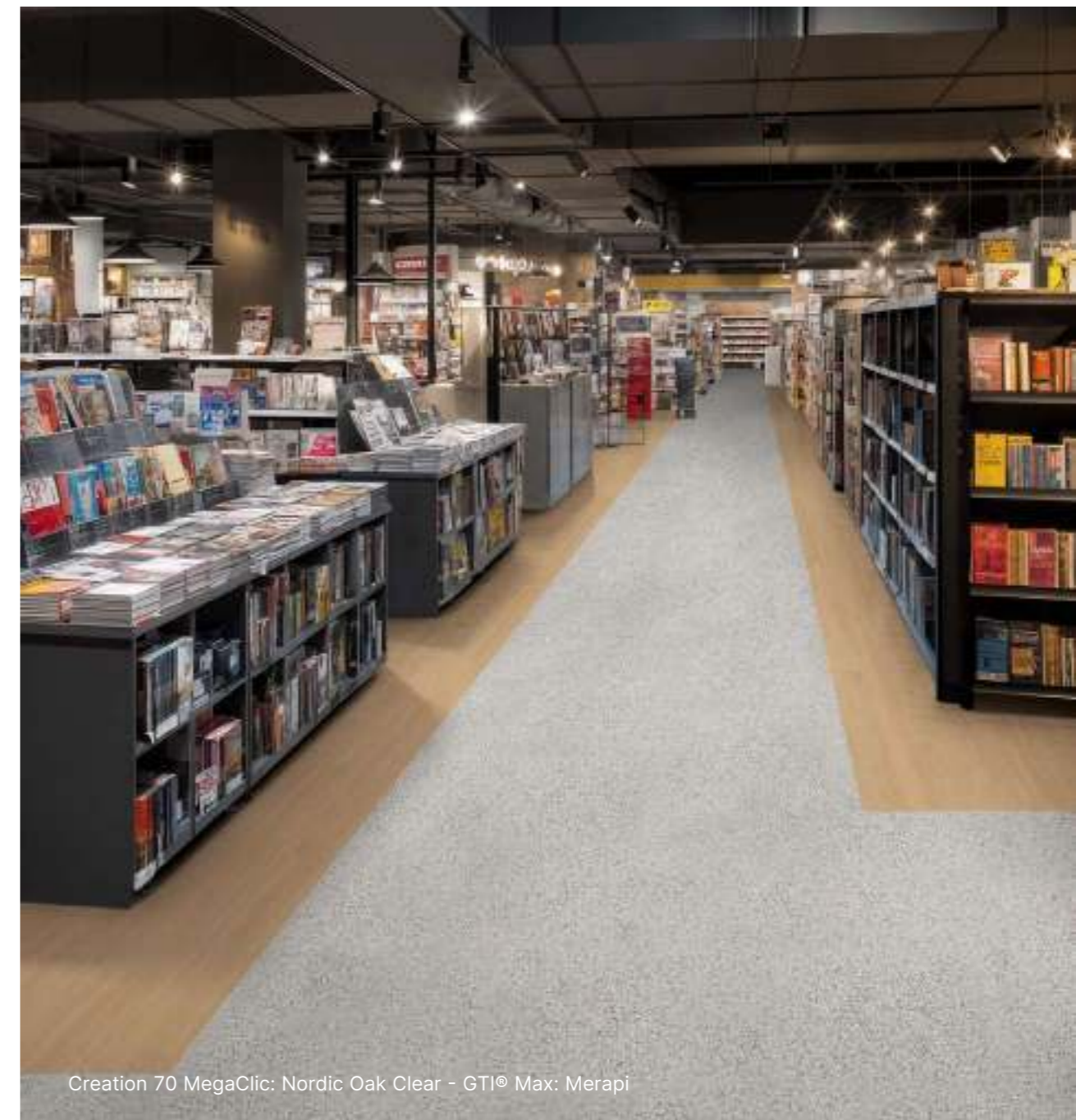

Creation 70 MegaClic: Nordic Oak Clear - GTI® Max: Merapi

# Creation Tiles & Planks

Creation 70 MegaClic **New**



## Bodega



1766 Bodega Chestnut



1767 Bodega Natural

## Albion



0577 Albion



1763 Albion Honey



1762 Albion Beige



Albion Beige



0545 Serena



0800 Toasted Wood Roadster



1764 Nordic Oak Clear



0358 Moon Island



1052 Muse Sand



0357 Portobello



1765 Nordic Oak Natural



0538 Midwest



Nordic Oak Clear - Prado Grey

# Creation Tiles & Planks

## Creation 70 MegaClic New



### Camino



1771 Camino Medium Grey



1770 Camino Light Grey



1772 Camino Dark Grey



0088 Oxyd Pure



1769 Tela Denim



Tela Denim



Creation 70 MegaClic: 1771 Camino Medium Grey / GTI® Max: 2265 Merapi



1768 Rapolano Light Beige



1773 Shady Concrete Grey



0085 Dock Grey



1069 Etna Dark



### Prado



1064 Prado Green

Color scan scale: 1 / 5



1774 Prado Grey

Color scan scale: 1 / 5



# Creation Tiles & Planks

Creation 70 MegaClic **New**

## we care / we act our commitments for 2030



### Climate

Low CO<sub>2</sub> footprint / EPD available



### Ressources

Recycled content 29% / Mineral & recycled content = 77%



### Circularity

Adhesive free / easy re-cycle (Gerflor Second Life program)



### Indoor air quality

Best-in-class performance A+ Certified & Floorscore



GTI® Max Carbon / Creation 70 MegaClic Albion

## Full Design Concept



Aluminium Ramp  
Code: 0505



PVC Ramp  
Code: 0500  
(colours: Lead, Linen)

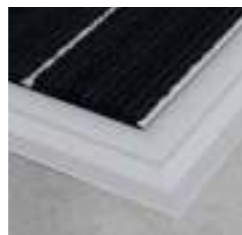

Entrance mat  
Esplanade 9000  
Code: 1700



Anti Bounce Mallet  
Code: 5951



Welding rods CR50  
Code: H009

## Ultra Natural Look & Feel

More than 60% of our collection is using our new emboss technology - designed by our Artistic Team.



### NEW Scandinavian

A delicate surface, with a linear grain that accentuates the orientation of the material.



### Brushed

The sensory expression of rustic wood, with a structured and random surface.



### Hammered

A surface with a slightly grainy feel, where subtle irregularities evoke the authenticity of stone.



In addition to these ultra realistic embossing, Protecshield™ surface treatment offers a velvet touch, with a matt surface, ease of maintenance and micro scratch resistance.

# Acoustic Design tiles and planks LVT\*

Creation Zen

 A new generation of acoustic LVT from low to high traffic areas



Swiss Oak Golden

## High acoustic performance & comfort



### Zen for the planet

- Made in France
- Recycled content\*\* and 100% recyclable
- Lowest carbon footprint of all loose lay LVTs
- Phthalate-free\*



### Zen for the user

- Protecshield™ surface treatment, microscratch-resistant and easy to clean
- Acoustic insulation: 20 dB
- Better impact sound absorption: 65 dB

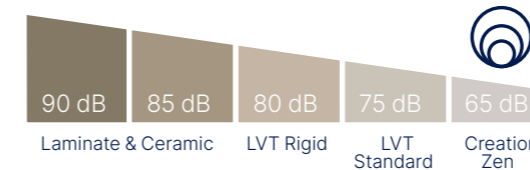

### Zen for the installer

- Loose lay installation on to tackifier
- Flexible and lightweight to make cutting easier
- Replaceable: quick installation and removal

\* Excluding recycled content  
\*\* Creation 55 Zen / Creation 70 Zen



Parker Station



Our tiles and planks have 4 bevelled edges for aesthetic real life effect

# Acoustic Design tiles and planks LVT

## Creation 40/55/70 Zen

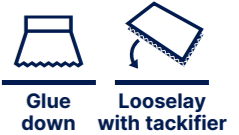

**22 colors:**  
Creation 40 Zen

**30 colors:**  
Creation 55/70 Zen



### New designs

- 4 bevelled edges
- Available in 3 sizes
- MyCreation Zen custom designs available



### New surface treatment

- Extra-matt appearance
- Micro-scratch-resistant
- Easy maintenance



### The whole picture

- S0001 skirting board matches your floor or in plain white to paint and match other design elements in the room

### Looselay installation with tackifier or glue down

## Creation 40/55/70 Zen

**CREATION 55 / 70 ZEN** is an acoustic and decorative floor, in PVC multilayers reinforced with 2 fiber glass layers, available in tile and plank format, with 4 beveled edges. It has an antistatic abrasion group T, and R10 antislip performance. **CREATION 40 ZEN** is reinforced with a fiber veil.

**CREATION 55 ZEN** consists in a 0.55 mm thick transparent wear layer, the overall thickness is 4.25 mm. 0.70 mm / 4.35 mm for Creation 70 Zen. 0.40 mm / 3.60 mm for Creation 40 Zen.

**The high density foam** provides good **indentation resistance** of 0.12 mm. (average mesure) and **high acoustic insulation level** (-20dB).

### CREATION 55/70 ZEN

Thanks to its double reinforcement, **fiber veil + fiber grid**, and to a **calendared intermediate layer** which gives it greater density, the coating retains its dimensional **stability** under the effect of a temperature variation (<0.03%).

It benefits from a cross-linked polyurethane surface treatment (**Protecshield™**) for making maintenance easier and prevent from micro-scratches.

**CREATION 40 ZEN** is 23/32 according to EN-ISO 10874 (residential / commercial use). **CREATION 70 ZEN** is 34/42 according to EN-ISO 10874 (commercial / industrial use).

**CREATION 55 ZEN** is resistant to high traffic (commercial / industrial use) 33/42 according to EN-ISO 10874 and has Bfl-s1 class for smoke emission according to EN 13501-1.

**CREATION ZEN is a looselay product**, maintained with tackifier.

This installation allows, among other things, an installation on asbestos-contaminated support, and is removable.

**CREATION 55/70 ZEN: 23% recycled content** and **phthalate free** plasticizers (excepted recycled content). It is 100% recyclable and 100% compliant with REACH.

## Creation 40 Zen

- ① ProtecShield™
- ② Transparent wearlayer
- ③ Printed design
- ④ Reinforced fiber veil
- ⑤ Compact interlayer
- ⑥ Very High Density foam

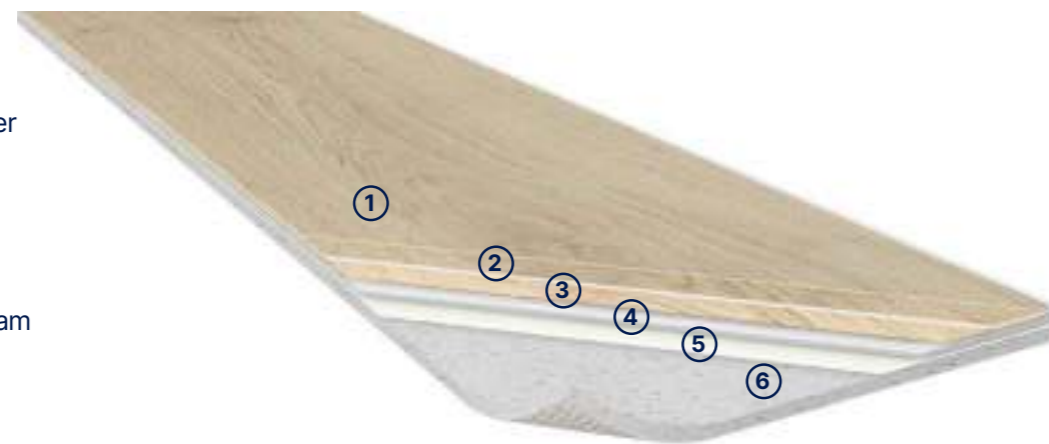

## Creation 40 Zen

- An **aesthetic & economical solution** for homes
- ✓ Integrated acoustic layer: **20 dB**

## Creation 55 Zen Creation 70 Zen

- An exclusive, **eco-designed** solution for **quick installation** in high-traffic locations
- ✓ **23% recycled content**
- ✓ 2 reinforcements = improved stability
- ✓ integrated acoustic layer: **20 dB**

## Creation 55/70 Zen

- ① ProtecShield™
- ② Cristal wearlayer
- ③ Printed design
- ④ Fiber veil
- ⑤ Compact layer
- ⑥ Fiber grid
- ⑦ Calandered layer with recycled PVC
- ⑧ Acoustic resilient foam

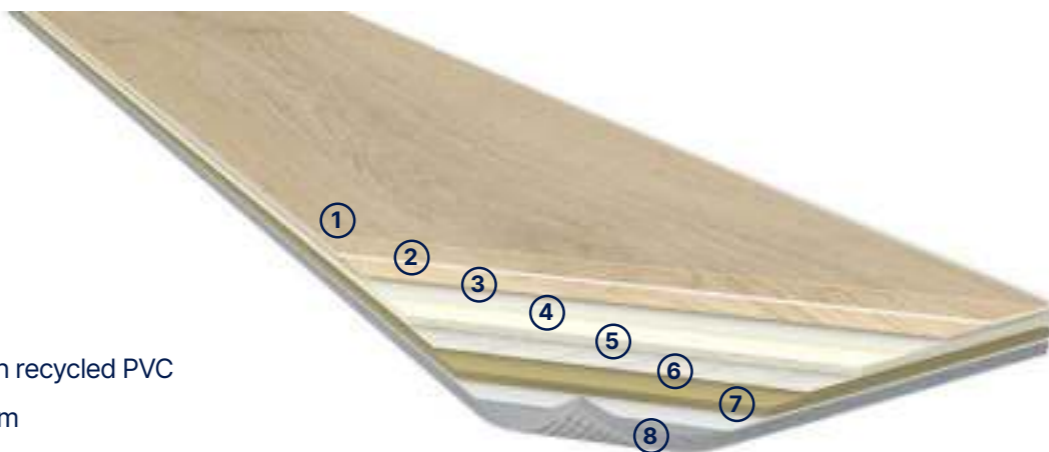

Nature Oak Taupe

**MADE  
& RECYCLED  
IN FRANCE**

# Acoustic Design tiles and planks LVT

Creation 40/55/70 Zen

Formats details on page 176

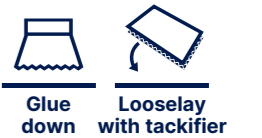

## Nature Oak



1480 Nature Oak Honey

C40 Zen  
C55 Zen  
C70 Zen



1479 Nature Oak Kraft

C40 Zen  
C55 Zen  
C70 Zen



1481 Nature Oak Taupe

C40 Zen  
C55 Zen  
C70 Zen



## Bostonian Oak



1416 Bostonian Oak Beige

C40 Zen  
C55 Zen  
C70 Zen



1478 Bostonian Oak Kraft

C40 Zen  
C55 Zen  
C70 Zen



1415 Bostonian Oak

C40 Zen  
C55 Zen  
C70 Zen



1422 Bostonian Oak Medium

C40 Zen  
C55 Zen  
C70 Zen



1421 Bostonian Oak Dark

C40 Zen  
C55 Zen  
C70 Zen



## Swiss Oak

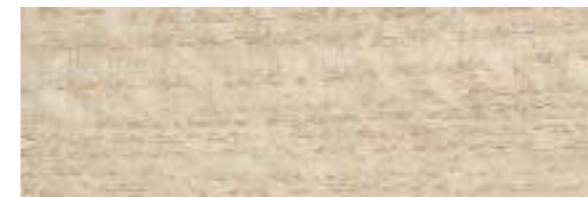

1418 Swiss Oak Beige

C40 Zen  
C55 Zen  
C70 Zen



1419 Swiss Oak Golden

C40 Zen  
C55 Zen  
C70 Zen



1420 Swiss Oak Pearl

C40 Zen  
C55 Zen  
C70 Zen



1417 Twist

C40 Zen  
C55 Zen  
C70 Zen



## Ranch



0773 Ranch

C40 Zen  
C55 Zen  
C70 Zen



0953 Ranch Anthracite

C40 Zen  
C55 Zen  
C70 Zen



Swiss Oak Beige

# Acoustic Design tiles and planks LVT

Creation 40/55/70 Zen

Formats details on page 176

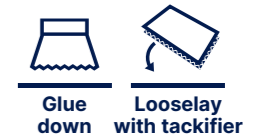

## Bloom Uni



1484 Bloom Uni Brown  
C55 Zen  
C70 Zen



1412 Bloom Uni Taupe  
C40 Zen  
C55 Zen  
C70 Zen



1482 Bloom Uni Clear  
C55 Zen  
C70 Zen



1413 Bloom Uni Grey  
C40 Zen  
C55 Zen  
C70 Zen

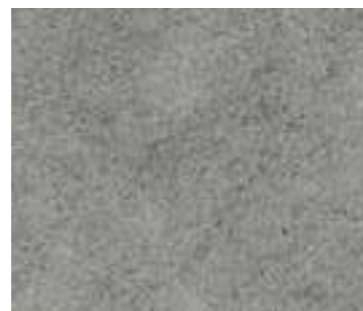

1485 Bloom Uni Souris  
C40 Zen  
C55 Zen  
C70 Zen

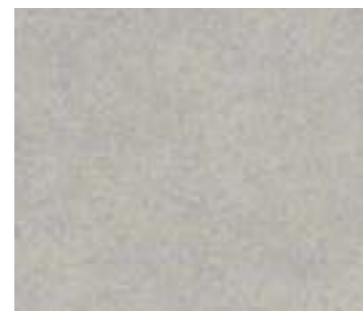

0963 Bloom Uni Perle  
C40 Zen  
C55 Zen  
C70 Zen



1483 Bloom Uni Black  
C55 Zen  
C70 Zen



Finesse Nature / Bloom Uni Taupe

## Finesse



1064 Finesse Nature  
C55 Zen  
C70 Zen



1066 Finesse Poudre  
C55 Zen  
C70 Zen



1489 Finesse Grey  
C40 Zen  
C55 Zen  
C70 Zen



1488 Finesse Denim  
C55 Zen  
C70 Zen



1063 Finesse Brown  
C40 Zen  
C55 Zen  
C70 Zen

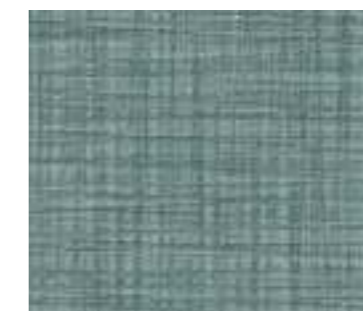

1487 Finesse Green  
C55 Zen  
C70 Zen



1414 Parker Station  
C40 Zen  
C55 Zen  
C70 Zen



1486 Parker Clear  
C40 Zen  
C55 Zen  
C70 Zen



Finesse Brown



0817 Cocoon Metal  
C55 Zen  
C70 Zen

# Acoustic Design tiles and planks LVT

## Creation 40/55/70 Zen

Code	Color Design	Creation 40 Zen	Creation 55 Zen	Creation 70 Zen	Skirting Matching Design	Coverstrip Matching Design	NCS	LRV
1483	Bloom Uni Black	*	500x500	500x500	-	C023	8000-N	5,8
1484	Bloom Uni Brown	*	500x500	500x500	-	-	5005-Y50R	22,3
1482	Bloom Uni Clear	*	500x500	500x500	-	-	3005-Y50R	45,1
1413	Bloom Uni Grey	500x500	500x500	500x500	S096	C016	5005-R50B	21,8
0963	Bloom Uni Perle	500x500	500x500	500x500	-	C017	3005-R20B	43
1485	Bloom Uni Souris	500x500	500x500	500x500	-	C016	4502-R	27,3
1412	Bloom Uni Taupe	500x500	500x500	500x500	S095	C019	4502-Y	27,7
1415	Bostonian Oak	245x1250	245x1250	245x1250	S016	C006	4010-Y50R	26,2
1416	Bostonian Oak Beige	245x1250	245x1250	245x1250	S017	C019	4005-Y50R	31,9
1421	Bostonian Oak Dark	245x1250	245x1250	245x1250	-	-	6005-Y80R	15
1478	Bostonian Oak Kraft	245x1250	245x1250	245x1250	S201	C002	3010-Y40R	36
1422	Bostonian Oak Medium	245x1250	245x1250	245x1250	-	-	6010-Y50R	15,6
0817	Cocoon Metal	*	500x500	500x500	-	-	4005-Y20R	34,7
1063	Finesse Brown	500x500	500x500	500x500	-	-	3010-Y50R	36
1488	Finesse Denim	*	500x500	500x500	-	-	5010-R90B	19,7
1487	Finesse Green	*	500x500	500x500	-	-	5010-B70G	20,7
1489	Finesse Grey	500x500	500x500	500x500	-	C019	4005-Y80R	29,5
1064	Finesse Nature	*	500x500	500x500	-	C019	3502-Y	37,6
1066	Finesse Poudre	*	500x500	500x500	-	-	3010-R10B	40,5
1480	Nature Oak Honey	245x1250	245x1250	245x1250	S192	C007	5010-Y30R	19,5
1479	Nature Oak Kraft	245x1250 150x750	245x1250 150x750	245x1250 150x750	-	C004	4010-Y30R	32,5
1481	Nature Oak Taupe	245x1250 150x750	245x1250 150x750	245x1250 150x750	-	C014	5005-Y50R	20,7
1486	Parker Clear	500x500	500x500	500x500	-	C019	4005-Y50R	29
1414	Parker Station	500x500	500x500	500x500	-	C015	6000-N	17,1
0773	Ranch	245x1250	245x1250	245x1250	S053	C014	5005-Y20R	25,3
0953	Ranch Anthracite	245x1250	245x1250	245x1250	-	-	6005-Y80R	16,4
1418	Swiss Oak Beige	245x1250	245x1250	245x1250	S011	B208	3010-Y50R	44,1
1419	Swiss Oak Golden	245x1250	245x1250	245x1250	S015	C003	4020-Y30R	26,4
1420	Swiss Oak Pearl	245x1250	245x1250	245x1250	S014	C010	3500-N	36,5
1417	Twist	245x1250	245x1250	245x1250	S039	C011	3010-Y50R	44

\* Colour available on order, minimum quantity 700 m<sup>2</sup>

## Packaging

Format (mm)	m <sup>2</sup> /box	m <sup>2</sup> /palett	Format (mm)	m <sup>2</sup> /box	m <sup>2</sup> /palett	Format (mm)	m <sup>2</sup> /box	m <sup>2</sup> /palett
<b>Creation 40 Zen</b>			<b>Creation 55 Zen</b>			<b>Creation 70 Zen</b>		
245 x 1250	4,29	192,9	245 x 1250	3,37	151,6	245 x 1250	3,37	151,6
150 x 750	4,28	179,6	150 x 750	3,49	146,5	150 x 750	3,49	146,5
500 x 500	4,5	234	500 x 500	3,75	195	500 x 500	3,75	195



Finesse Nature / Finesse Denim

# Creation Tiles & Planks

My Creation / My Creation Zen / My Saga<sup>2</sup>

## Design your floor

As you are unique and each of your projects represents a new challenge, Gerflor gives you the chance to stand out, from 200 sqm.

One atmosphere, one style, one floor, but several possibilities...

My Creation \_\_\_\_\_

### Available installations:

My Creation 70 Dry Back  
My Creation 55 Dry Back

### Available formats:

Plank: 184 × 1219 mm  
XL Tile: 496 × 996 mm



My Creation Zen \_\_\_\_\_

### Available formats:

Plank: 245 × 1250 mm et 150 × 750 mm  
Tile: 500 × 500 mm



My Saga<sup>2</sup> \_\_\_\_\_

### Available format:

Tile: 500 × 500 mm



My Creation, My Creation Zen and My Saga<sup>2</sup> collections are available on gerflor.com

Do not hesitate to contact your sales representative



## 3 Possibilities

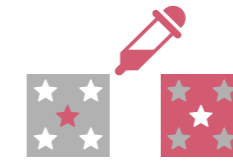

### 1 - Colour

Set the tone of your project by recolouring the design of your choice in our Creation or Creation Saga<sup>2</sup> ranges



### 2 - Collection

Leave a big impression on the atmosphere that you create thanks to our unique collection of 50 designs that reflect the major decorative trends that are popular today.

All of our customisable designs: [myfloorbygerflor.com](http://myfloorbygerflor.com)



### 3 - Customisation

Enhance the visual identity of your company or that of your clients by printing a logo and/or your own designs.

## My Creation, My Creation Zen, My Saga<sup>2</sup>

Let's bring your inspiration to life together!

# Creation Tiles & Planks

## Technical data











			Creation 30	Creation 40	Creation 40 Clic	Creation 40 Clic Acoustic	Creation 55			Creation 55 Clic	Creation 55 Clic Acoustic	Creation 55 Looselay	Creation 55 Looselay Acoustic	Creation 40 Zen	Creation 55 Zen	Creation 70 Zen	
							Arte	Trend	Design								
Description																	
Total Thickness	EN ISO 24346	mm	2	2	4.50	5.50	2.50			5.00	6.00	4.50	5.50	3.60	4.25	4.35	
Thickness of the wearlayer	EN ISO 24340	mm	0.30	0.40	0.45	0.45	0.55			0.55	0.55	0.55	0.55	0.40	0.63	0.70	
Weight	EN ISO 23997	g/m <sup>2</sup>	3460	3430	7118	7229	3850			7781	8024	9480	7500	7600	2675	3570	3670
Size	EN ISO 24342	mm	Plank - 184.15x1219.2 / 230x1500 Tile - 457.2x914.4 / 609.6x609.6	Plank - 184.15x1219.2 / 230x1500 Tile - 457.2x914.4	Plank - 212x1238.8 / 239.6x1460.8 Tile - 388.8x728.7	Plank - 212x1238.8 / 239.6x1460.8 Tile - 388.8x728.7	Plank - 184.15x1219.2 Tile - 496.5x996.5	Plank - 184.15x1219.2 / 230x1500 / 152.4x762 Tile - 457.2x914.4 / 609.6x609.6	Plank - 184.15x1219.2 (EIR) / 133.35x800.1 / 230x1500 (EIR) Tile - 609.6x609.6 / 914.4x914.4	Plank - 212x1238.8 / 239.6x1460.8 Tile - 388.8x728.7	Plank - 212x1238.8 / 239.6x1460.8 Tile - 388.8x728.7	Plank - 229x1220 / 152x914 Tile - 600x600 / 914x914	Plank - 228.6x1220 Tile - 600x600	Plank - 245x1250 / 150x750 Tile - 500x500	Plank - 245x1250 / 150x750 Tile - 500x500	Plank - 245x1250 / 150x750 Tile - 500x500	
Number of planks & tiles / sqm per box	-	-	15-11-9-9 / 3.36-3.80-3.76-3.35	21-13-11 / 4.71-4.49-4.6	8-7-7 / 2.10-2.45-1.98	8-6-7 / 2.10-2.10-1.98	15-8 / 3.36-3.96	15-9-33-9-9 / 3.36-3.11-3.82-3.76-3.35	15-30-9-9-5 / 3.36-3.20-3.11-3.35-4.18	7-6-6 / 1.84-2.10-1.70	7-5-6 / 1.84-1.75-1.70	16 / 1.5	6-12-6-4 / 1.67-1.67-2.16-3.34	8-6 / 2.23-2.16	14-38-18 / 4.29-4.28-4.50	11-31-15 / 3.37-3.49-3.75	11-31-15 / 3.37-3.49-3.75
Phthalate free	-	-	OK	OK	OK	OK	OK			OK	OK	OK	OK	OK	OK	OK	OK
Classification																	
Norm/Product Specification	-	-	EN ISO 10582	EN ISO 10582	EN ISO 10582	EN ISO 10582	EN ISO 10582			EN ISO 10582	EN ISO 10582	EN ISO 10582	ISO 10582	EN ISO 11638	EN ISO 11638	EN ISO 11638	
European Classification	EN ISO 10874	class	23-31	23-32-41	23-32-41	23-32-41	33-42			33-42	33-42	33-42	33-42	23-32	33-42	34-42	
Fire Rating	EN 13501-1	class	Bfl-s1	Bfl-s1	Bfl-s1	Bfl-s1	Bfl-s1			Bfl-s1	Bfl-s1	Bfl-s1	Bfl-s1	Bfl-s1	Bfl-s1	Bfl-s1	
Static Electrical Propensity	EN 1815	kV	< 2	< 2	< 2	< 2	< 2			< 2	< 2	< 2	< 2	< 2	< 2	< 2	
Slip Resistance Wet	DIN 51 130	class	R10	R10	R10	R10	R10			R10	R10	R10	R10	R10	R10	R10	
Performances																	
Wear Resistance	EN 660.2	mm <sup>3</sup>	≤ 2.0	≤ 2.0	≤ 2.0	≤ 2.0	≤ 2.0			≤ 2.0	≤ 2.0	≤ 2.0	≤ 2.0	< 2.0	< 2.0	< 2.0	
Wear Group	-	-	T	T	T	T	T			T	T	T	T	T	T	T	
Type Binder content	EN ISO 10582	type	I	I	I	I	I			I	I	I	I	I	I	I	
Dimensional stability (norm)	EN ISO 23999	%	≤ 0.25	≤ 0.25	≤ 0.15	≤ 0.15	≤ 0.25			≤ 0.15	≤ 0.15	≤ 0.15	≤ 0.15	≤ 0.25	≤ 0.25	≤ 0.25	
Dimensional stability (average measured value)	-	%	≈ 0.10	≈ 0.10	≈ 0.05	≈ 0.05	≈ 0.10			≈ 0.05	≈ 0.05	≈ 0.05	≈ 0.05	≈ 0.05	≈ 0.03	≈ 0.03	
Impact sound insulation	EN ISO 717-2	dB	4	4	4	19	4			4	19	7	19	20	20	20	
Room Impact	NF S 31 074	dB	77	77	79	79	77			79	79	74	70				
Residual indentation (norm)	EN ISO 24343-1	mm	-	-	-	-	-			-	-	≤ 0.10	≤ 0.10	≤ 0.20	≤ 0.20	≤ 0.20	
Residual indentation (average measured value)	EN ISO 24343-1	mm	-	-	-	-	-			-	-	-	-	0.12	0.12	0.12	
Castor chair test (Type W)	ISO 4918	-	OK	OK	OK	OK	OK			OK	OK	OK	OK	OK	OK	OK	
Thermal Conductivity	EN ISO 10456	W/(m.k)	0.25	0.25	0.25	0.25	0.25			0.25	0.25	0.25	0.25	0.25	0.25	0.25	
Colour Fastness	EN 20 105-B02	degree	≥ 6	≥ 6	≥ 6	≥ 6	≥ 6			≥ 6	≥ 6	≥ 6	≥ 6	≥ 6	≥ 6	≥ 6	
Chemical Products Resistance	EN ISO 26987	-	OK	OK	OK	OK	OK			OK	OK	OK	OK	OK	OK	OK	
Surface Treatment	-	-	ProtecShield™	ProtecShield™	ProtecShield™	ProtecShield™	ProtecShield™			ProtecShield™	ProtecShield™	ProtecShield™	ProtecShield™	ProtecShield™	ProtecShield™	ProtecShield™	ProtecShield™
Environment																	
Recycled content (average)	-	%	35	35	33	33	20	35	35	33	33	up to 35%	up to 35%	19	23	23	
Recyclability	-	%	100	100	100	100	100	100	100	100	100	100	100	100	100	100	
EPD	-	-	-	-	available	available	available			available	available	available	available	available	available	available	
Health																	
TVOC after 28 days	ISO 16000-6	micrograms/m <sup>3</sup>	< 10	< 10	< 10	< 10	< 10			< 10	< 10	< 10	< 10	< 10	< 10	< 10	
Floorscore®	-	-	OK	OK	OK	OK	OK			OK	OK	-	-	-	-	-	
SCS Global Certification	-	-	-	-	OK	OK	-			OK	OK	-	-	-	-	-	
CE Marking																	

CE EN 14041



# Creation Tiles & Planks

## Technical data

			Creation 70		Creation 70 Clic	Creation 70 Looselay	Creation 70 MegaClic	Creation 70 Connect	Creation Saga²		
	Arte	Design									
<b>Description</b>											
Total Thickness	EN ISO 24346	mm	2.50	2.50	5.00	5.00	6.00	5.00	4.60		
Thickness of the wearlayer	EN ISO 24340	mm	0.70	0.70	0.70	0.70	0.70	0.70	0.70		
Weight	EN ISO 23997	g/m²	3960	4100	7670	8300	9230	8235	5595		
Size	EN ISO 24342	mm	Plank - 184.15×1219.2 / Tile - 496.5 × 996.5	Plank - 230 × 1500 / Tile - 457.2 × 914.4 / 609.6 × 609.6 / 914.4 × 914.4	Plank 212 × 1238.8 / 239.6 × 1460.8 Tile 388.8 × 728.7	Plank - 235×1505 228.6×1220 152.4×914.4 Tile - 600×600 / 914.4×914.4	Plank - 200.5 × 1235.5 Tile - 489 × 989	701.3×701.3	500×500		
Number of planks & tiles / sqm per box	-	-	15 - 8 / 3.37 - 3.96	9 - 9 - 9 - 5 / 3.11 - 3.76 - 3.35 - 4.18	7 - 6 - 6 / 1.84 - 2.10 - 1.70	4-6-12-4-4 / 1.41-1.67-1.67-1.44-3.34	6-4 / 1.49-1.93	20 / 9.83	10 / 2.5		
Phthalate free	-	-	OK	OK	OK	OK		OK	OK		
<b>Classification</b>											
Norm/Product Specification	-	-	EN ISO 10582	EN ISO 10582	EN ISO 10582	EN ISO 10582	EN ISO 10582	EN ISO 10582	EN 652		
European Classification	EN ISO 10874	class	34-43	34-43	34-43	34-43	34-43	34-43	34-42		
Fire Rating	EN 13501-1	class	Bfl-s1	Bfl-s1	Bfl-s1	Bfl-s1	Bfl-s1	Bfl-s1	Bfl-s1		
Static Electrical Propensity	EN 1815	kV	< 2	< 2	< 2	< 2	< 2	< 2	< 2		
Slip Resistance Wet	DIN 51 130	class	R10	R10	R10	R10	R10	R10	R10		
<b>Performances</b>											
Wear Resistance	EN 660.2	mm³	≤ 2.0	≤ 2.0	≤ 2.0	≤ 2.0	≤ 2.0	< 2.0	≤ 2.0		
Wear Group	-	-	T	T	T	T	T	T	T		
Type Binder content	EN ISO 10582	type	I	I	I	I	I	I	I		
Dimensional stability (norm)	EN ISO 23999	%	≤ 0.25	≤ 0.25	≤ 0.15	≤ 0.15	≤ 0.15	≤ 0.15	≤ 0.15		
Dimensional stability (average measured value)	-	%	≈ 0.10	≈ 0.10	≈ 0.05	≈ 0.05	-	-	≈ 0.05		
Impact sound insulation	EN ISO 717-2	dB	4	4	4	7	5	5	15		
Room Impact	NF S 31 074	dB	77	77	79	74	78	75	< 65		
Residual indentation	EN ISO 24343-1	mm	≤ 0.10	≤ 0.10	≤ 0.10	≤ 0.10	≤ 0.10	≤ 0.10	< 0.13		
Castor chair test (Type W)	ISO 4918	-	OK	OK	OK	OK	OK	OK	OK		
Thermal Conductivity	EN ISO 10456	W/(m.k)	0.25	0.25	0.25	0.25	0.25	0.25	0.25		
Colour Fastness	EN 20 105-B02	degree	≥ 6	≥ 6	≥ 6	≥ 6	≥ 6	≥ 6	≥ 6		
Chemical Products Resistance	EN ISO 26987	-	OK	OK	OK	OK	OK	OK	OK		
Surface Treatment	-	-	ProtecShield™	ProtecShield™	ProtecShield™	ProtecShield™	ProtecShield™	PUR+ Matt	ProtecShield™		
<b>Environment</b>											
Recycled content (average)	-	%	20	35	33	jusqu'à 35%	29	29	25		
Recyclability	-	%	100	100	100	100	100	100	100		
EPD	-	-	available	available	available	available	available	available	available		
<b>Health</b>											
TVOC after 28 days	ISO 16000-6	micrograms/m³	< 10	< 10	< 10	< 10	< 10	< 10	< 10		
Indoor Air Comfort Gold. Floorscore®	-	-	OK	OK	OK	-	-	-	-		
SCS Global Certification	-	-	-	-	-	-	-	Floorscore®	-		
<b>CE Marking</b>											
						   			   		



# Carpet Tiles

pages 184-195

188. **Armonia 400**

192. **Armonia 540** **New**

194. **Armonia 620**



# Armonia 400

## Armonia 400 - 100% Polypropylene

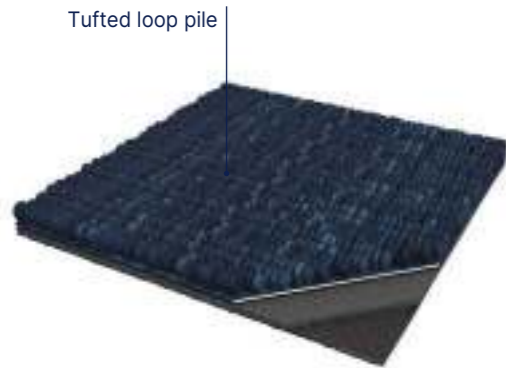

**Armonia 400** is a decorative, reliable, hardwearing textile floor covering. It consists in a tufted 50 × 50 cm loop pile carpet tile with a 2,3 mm pile height. The overall thickness is 5,3 mm with 400 pile weight.

**Armonia 400** is a 100% Polypropylene solution carpet tile with Bfl-s1 free floating on cement class for smoke emission according to EN 13501-1.

**Armonia 400** is REACH compliant. The product emission rate of organic compounds is < 100 micrograms/m<sup>3</sup> (TVOC < 28 days – EN 16516).

**B-connect** is a glue-free installation solution for Armonia tiles. The self-adhesive connectors are repositionable. They do not leave any marks on the back of the tile and keep the substrate clean. This solution promotes the recycling of tiles and simplifies the installation of a new covering on the preserved substrate.

The B-connect connectors are pre-cut and delivered in rolls of 200 connectors, covering approximately 50m<sup>2</sup> of Armonia tiles.



- **Easy mix with Gerflor collections** (Creation & Saga<sup>2</sup>)

- **Tile format** 500×500 mm

- **Light commercial use**

- **Indoor Air Quality**

TVOC <100µg/m<sup>3</sup> (ISO 16516 - after 28 days)

- **Installation**

Monolithic or quarter-turn

- **Adhesive free possible**

with connectors (B connect)

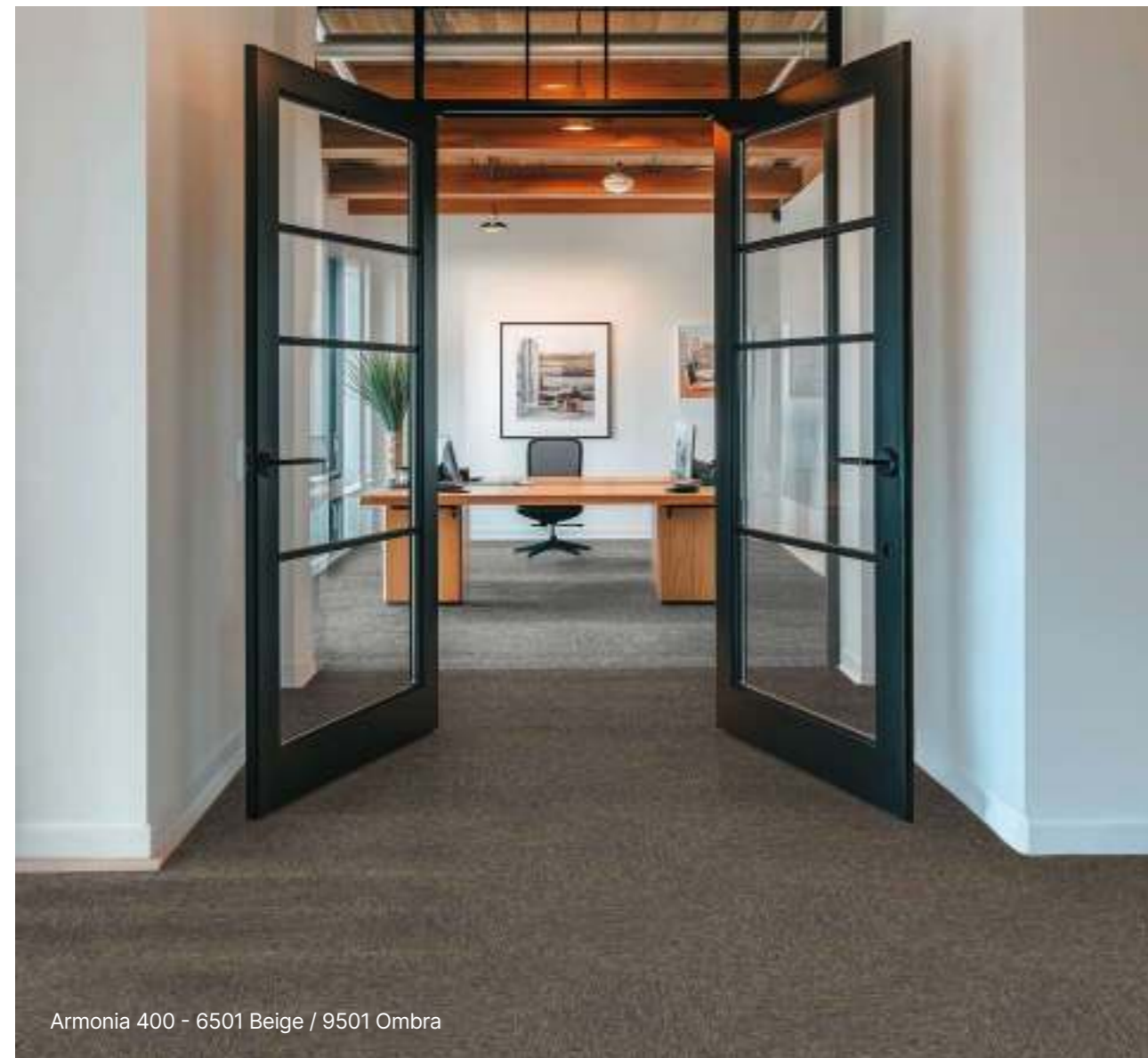

### Armonia 400

Description			
Nature	ISO 2424	-	Loose-laid carpet tile
Construction	ISO 2424	-	Tufted loop pile
Pile Material	-	-	100% Polypropylene
Backing	ISO 2424	-	Bitumen
Gauge	ISO 1763	-	1/10
Pile Weight	ISO 2424	g/m <sup>2</sup>	400
Surface Pile Weight	ISO 2424	g/m <sup>2</sup>	240
Stitch Density	ISO 1763	tufts/m <sup>2</sup>	145 800
Total Weight	ISO 8543	g/m <sup>2</sup>	3790
Total Thickness	ISO 1765	mm	5.3
Pile Height	ISO 1766	mm	2.3
Size	ISO 24342	cm	50 × 50
Classification			
European Classification	EN 1307	class	31
Fire Rating	EN 13 501-1	class	Bfl-s1 affixed on cement
Static Electrical Propensity	ISO 6536	kV	≤2
Luxury Rating	EN 1307	class	LC1
Slip resistance	EN 13893	µ	≥0.3
Performances			
Dimensional Stability	EN 986	%	≤0.2
Thermal Resistance	ISO 8302	m <sup>2</sup> C°/W	≤0,09 (0,0578)
Color Fastness	EN ISO 105 - B02	degree	≥6
Environment			
Recyclability	-	%	100
Health			
TVOC after 28 days	EN 16516	micrograms/m <sup>3</sup>	≤100
Label GuT	n° GUT - Prodis		BFACFED8
CE Marking			
CE	EN 14041	-	

Packaging		
Tiles per Box	unit	24
Tiles per Box	m <sup>2</sup>	6
Weight per Box	kg	22,96
Box per Pallet	unit	24
Pallet	m <sup>2</sup>	144

# Armonia 400

Comfort  
500 x 500 mm

100% recyclable

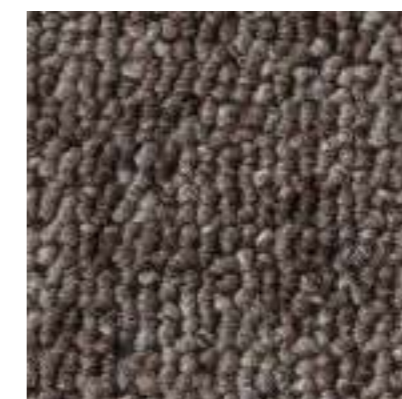

6501 Beige

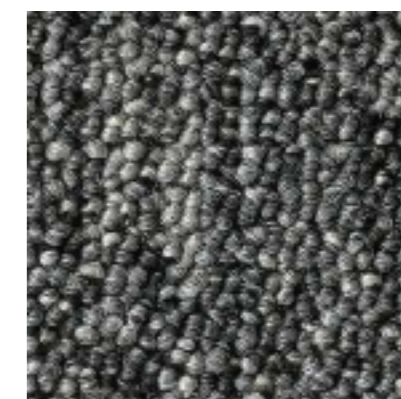

9501 Ombra



7801 Cacao

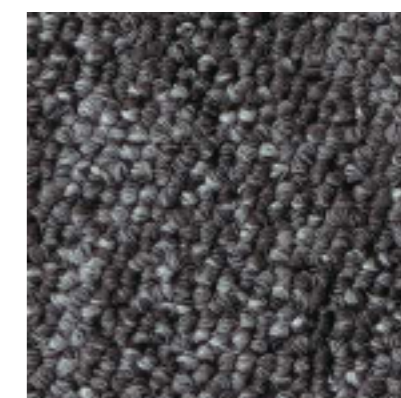

9701 Titanio

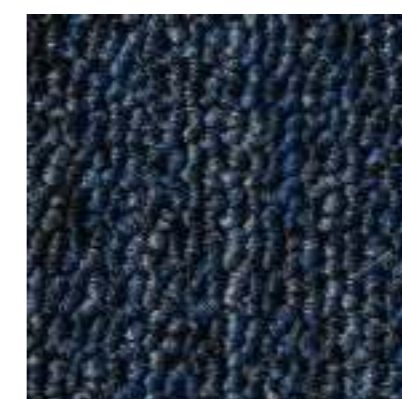

1801 Indigo

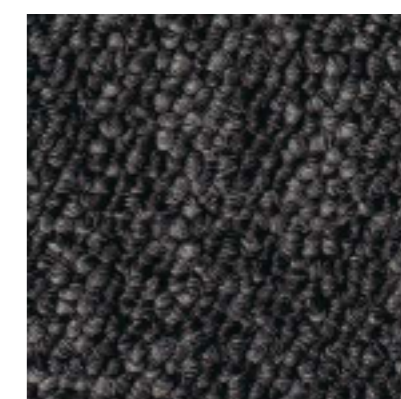

9901 Oxford

Scale 1

Creation 55 Looselay - 1559 Tamo Light / Armonia 400 - 7801 Cacao

# Armonia 540 <sup>New</sup> & 620

## Armonia 540 - Nylon - 540g/m<sup>2</sup>

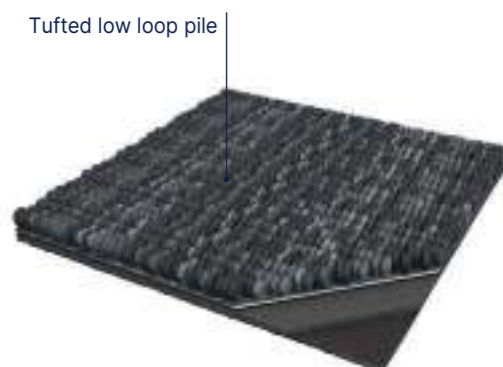

Tufted low loop pile

**Armonia 540** is a decorative, reliable, hardwearing textile floor covering. It consists in a tufted 50 × 50 cm low loop pile carpet tile with a 2,3 mm pile height. The overall thickness is 5,5 mm with a 540 g/m<sup>2</sup> pile weight.

**Armonia 540** is a 100% Nylon piece dyed carpet tile with resistance to use (commercial) of 33 according to EN 1307 and has Bfl-s1 free floating on cement class for smoke emission according to EN 13501-1.

**Armonia 540** has an impact sound insulation of 24 dB according to the EN ISO 10140 and a noise reduction of 0.15 αw ISO 11654.

**Armonia 540** is REACH compliant. The product emission rate of organic compounds is < 100 micrograms/m<sup>3</sup> (TVOC < 28 days – EN 16516).

## Armonia 620 - Econyl 100% recycled - 620g/m<sup>2</sup>

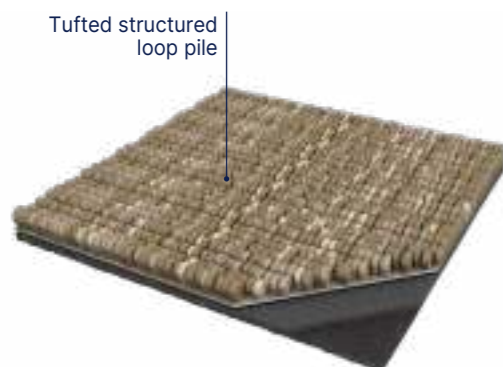

Tufted structured loop pile

**Armonia 620** is a decorative, reliable, hardwearing textile floor covering. It consists in a tufted 50 × 50 cm structured loop pile carpet tile with a 3,2 mm pile height. The overall thickness is 6,5 mm with 620 pile weight.

**Armonia 620** is a 100% Nylon solution dyed carpet tile with resistance to use (commercial) of 33 according to EN 1307 and has Bfl-s1 free floating on cement class for smoke emission according to EN 13501-1.

**Armonia 620** has an impact sound insulation of 24 dB according to the EN ISO 10140 and a noise reduction of 0.20 αw according to the ISO 11654.

**Armonia 620** contents 15% of recycled content. It is REACH compliant. The product emission rate of organic compounds is < 100 micrograms/m<sup>3</sup> (TVOC < 28 days – EN 16516).

**B-connect** is a glue-free installation solution for Armonia tiles. The self-adhesive connectors are repositionable. They do not leave any marks on the back of the tile and keep the substrate clean. This solution promotes the recycling of tiles and simplifies the installation of a new covering on the preserved substrate.

The B-connect connectors are pre-cut and delivered in rolls of 200 connectors, covering approximately 50m<sup>2</sup> of Armonia tiles.



Armonia 620 - 6103 Polvere



- For intensive commercial use
- Specific colours for perfect mix with Gerflor collections (Creation & Saga<sup>2</sup>)
- Tile format: 500×500 mm
- TVOC <100µg/m<sup>3</sup> ⇒ indoor air quality (ISO 16516 - after 28 days)

- Installation monolithic or quarter-turn
- Adhesive free possible with connectors (B connect)
- Third part certified EPD

	Armonia 540		Armonia 620	
<b>Description</b>				
Nature	ISO 2424	-	Loose-laid carpet tile	Loose-laid carpet tile
Construction	ISO 2424	-	Tufted low loop pile	Tufted structured loop pile
Pile Material	-	-	100% Polyamide	100% Polyamide Econyl®
Backing	ISO 2424	-	Bitumen	Bitumen
Gauge	ISO 1763	-	1/10	1/10
Pile Weight	ISO 2424	g/m <sup>2</sup>	540	620
Surface Pile Weight	ISO 2424	g/m <sup>2</sup>	325	420
Stitch Density	ISO 1763	tufts/m <sup>2</sup>	197 500	173 800
Total Weight	ISO 8543	g/m <sup>2</sup>	3955	4105
Total Thickness	ISO 1765	mm	5.5	6.5
Pile Height	ISO 1766	mm	2.3	3.2
Size	ISO 24342	cm	50 × 50	50 × 50
<b>Classification</b>				
European Classification	EN 1307	class	33	33
Fire Rating	EN 13 501-1	class	Bfl-s1	Bfl-s1
Static Electrical Propensity	ISO 6536	kV	≤2	≤2
Luxury Rating	EN 1307	class	LC1	LC2
Slip resistance	EN 13893	μ	≥0.3	≥0.3
<b>Performances</b>				
Noise reduction	ISO 11654	αw	0.15	0.20
Impact Sound Insulation	ISO 140-8	dB	22	24
Dimensional Stability	EN 986	%	≤0.2	≤0.2
Castor Chair Test (type H)	ISO 4918	-	≥2.4	≥2.4 (Class A)
Thermal Resistance	ISO 8302	m <sup>2</sup> C°/W	< 0.09 (0.0545)	<0.09 (0,0726)
Color Fastness	EN ISO 105 - B02	degree	>7/8	>7/8
<b>Environment</b>				
Recyclability	-	%	100	100
<b>Health</b>				
TVOC after 28 days	EN 16516	micrograms/m <sup>3</sup>	≤100	≤100
Label GuT	n° GUT - Prodis	-	7FDF1AC0	BAEA3BAE
EPD	-	-	Available	Available
<b>CE Marking</b>				
CE	EN 14041	-		

Packaging		Armonia 540	Armonia 620
Tiles per Box	unit	24	20
Tiles per Box	m <sup>2</sup>	6	5
Weight per Box	kg	24,34	20,89
Box per Pallet	unit	20	20
Pallet	m <sup>2</sup>	120	100

# Armonia 540 New



1795 Grafite



1796 Oceano

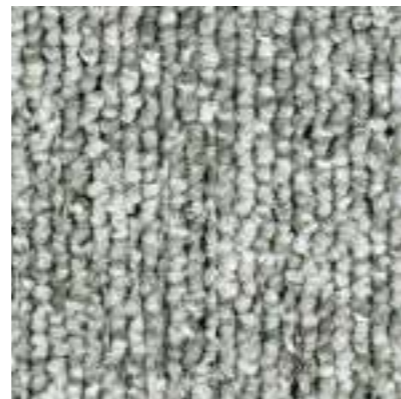

1798 Celeste



1793 Ferro

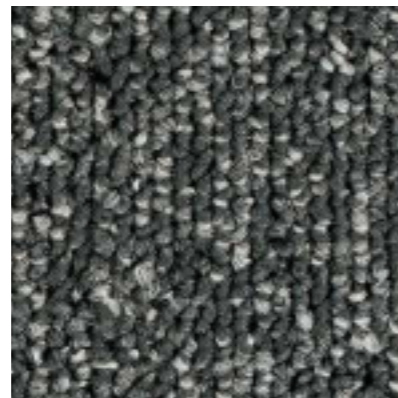

1797 Marino



1794 Platino



Armonia 540 - 1794 Platino



1792 Perla



1791 Talpa



1790 Canapa



1801 Corallo



1802 Toscano



1803 Ambra



1800 Foglia



1799 Bosco

Scale 1

# Armonia 620



6103 Polvere



9203 Nuvola



6273 Argilla



2173 Salvia



9303 Piombo



9503 Antracite

Scale 1



## Wall Solutions

pages 196-211

### 198. Wall panels & tiles

- 198. Mural Revela **New**
- 204. Mural Revela accessories **New**

### 206. Wall coverings

- 208. Mural Ultra Design
- 210. Mural Club
- Mural Calypso  
(See page 252)

# Wall panels & tiles

## Mural Revela **New**

### Mural Revela

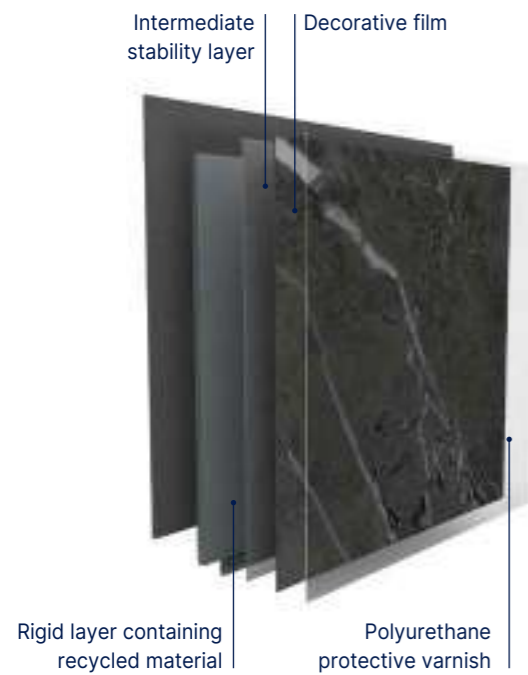

**MURAL REVELA** is a rigid vinyl wall covering which has a thickness of 5mm for an extended durability. It is available in 2 formats of 65 × 37,5cm for tiles or 260 × 90cm / 260 × 120cm for panels. It is intended for indoor use.

Its non-porous conception, its tongue and groove assembly system combined with a glued installation give **MURAL REVELA** a water resistance allowing an installation in wet areas including showers. Thanks to its robust conception and the total thickness of the product, **MURAL REVELA** is an ideal solution for renovation on ceramic tiles.

It has a fire reaction classification D-s3,d0 according to EN13501. It has excellent chemical resistance according to EN 423. It will be CMR 1 & 2 free and 100% Reach compliant. TVOC 28-day air emissions (NF EN 16000-6) will be classified as A+ (best class) under French health labelling.

**MURAL REVELA** has been designed and is produced in Europe. **MURAL REVELA** contains up to 30% recycled and is 100% recyclable. It can be collected and recycled through the Gerflor Second Life programme (selected countries).



- Tile and XL/XXL panel sizes
- Groove/tongue assembly
- Suitable for new builds
- Refurbishment over existing ceramic tiles
- Easy and quick to install
- Water resistant
- Washable product
- Installation in shower and/or bathtub area

				Mural Revela		
				Tile	XL Panel	XXL Panel
<b>Description</b>						
Total thickness	EN ISO 24346	mm		5		
Weight	EN ISO 23997	g/sqm		Matt: 6750 / Gloss: 7500		
Size	NF EN ISO 24341	cm		65 × 37,5	90 × 260	120 × 260
Chanfrein	-	-	Oui	Non	Non	
Phthalate free	-	-		OK		
<b>Classification</b>						
Product specification	-	-		EN 15 102		
Fire rating	EN 13501-1	class		D-s3,d0		
<b>Performances</b>						
Surface Treatment	-	-		OK		
Cleanability	EN 233	-		Washable and brushable		
<b>Environment</b>						
Recycled content (average)	-	%		25		
Recyclability	-	%		100		
EPD	-	-		Available		
<b>Health</b>						
TVOC after 28 days	ISO 16516	µg/ m³		<100		
<b>CE marking</b>						
				EN 15102	OK DOP 036-2001-8	

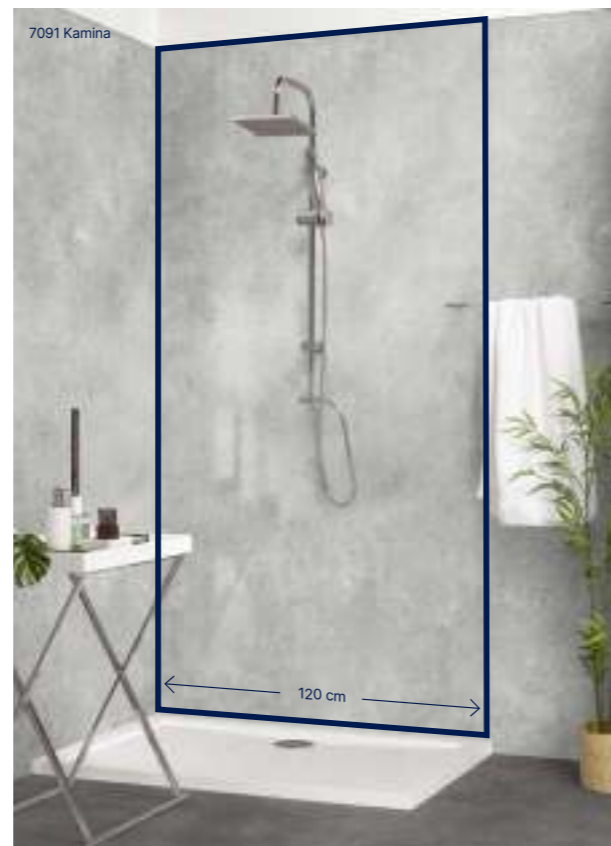

# Wall panels & tiles

## Mural Revela **New**



7029 Tanami Gloss ^ Scale 1  
 65 x 37,5 cm | 90 x 260 cm / 120 x 260 cm



7868 Ubeda  
 65 x 37,5 cm | 90 x 260 cm / 120 x 260 cm



7097 Boufia Gloss  
 65 x 37,5 cm | 90 x 260 cm



7053 Zanzibar  
 65 x 37,5 cm | 90 x 260 cm

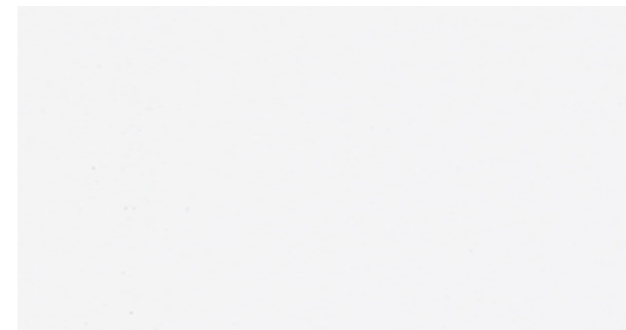

7918 Hanoi  
 65 x 37,5 cm | 90 x 260 cm



7035 Corabia  
 65 x 37,5 cm | 90 x 260 cm



7869 Baeza  
 65 x 37,5 cm | 90 x 260 cm



7032 Alanya  
 65 x 37,5 cm | 90 x 260 cm / 120 x 260 cm



7059 Derby Gloss  
 65 x 37,5 cm | 90 x 260 cm



7007 Vilnius  
 65 x 37,5 cm | 90 x 260 cm



7072 Sarti  
 65 x 37,5 cm | 90 x 260 cm



7052 Colima  
 65 x 37,5 cm | 90 x 260 cm

# Wall panels & tiles

## Mural Revela **New**



7093 Ampara ^ Scale 1  
65 × 37,5 cm 90 × 260 cm



7911 Liverpool  
65 × 37,5 cm 90 × 260 cm



7091 Kamina  
65 × 37,5 cm 90 × 260 cm / 120 × 260 cm



7915 Kampala  
65 × 37,5 cm 90 × 260 cm



Perfect harmony between  
**Creation & Mural Revela**

**7** matching designs  
Creation & Mural  
Revela



7099 Marmor White  
90 × 260 cm



7100 Terrazzo Cobalt  
65 × 37,5 cm



7101 Concrete Clear  
65 × 37,5 cm



7095 Travertine Bone  
65 × 37,5 cm 90 × 260 cm



7102 Concrete Cream  
65 × 37,5 cm



7098 Marbre Noir Gloss  
90 × 260 cm













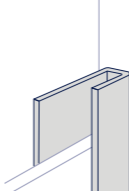



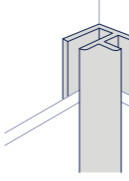



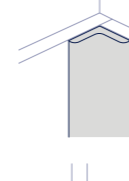

7096 Wood Clear  
65 × 37,5 cm 90 × 260 cm

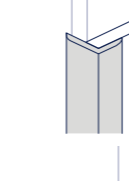
# Wall panels & tiles

Mural Revela accessories **New**

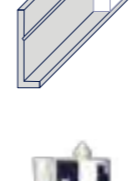

## A complete solution with aluminum profiles for a perfect finish

	<p><b>U finishing trim</b> Code: 0649 + color code</p>		Aluminium - 0001		Black - 0002		White - 0003
	<p><b>Universal angle</b> Code: 0644 + color code</p>		Aluminium - 0001		Black - 0002		White - 0003
	<p><b>Internal angle</b> Code: 0657 + color code</p>		Aluminium - 0001		Black - 0002		White - 0003
	<p><b>L-profile external angle</b> Code: 0653 + color code</p>		Aluminium - 0001				
	<p><b>Click finishing profile</b> Code: 0643 + color code</p>		Aluminium - 0001				
	<p><b>Start trim</b> Code: 0652 + color code</p>		Aluminium - 0001				
	<p><b>New</b> <b>Revela Fix</b> Code: 0633 MS Polymer White Glue 290 ML = ± 1.5m<sup>2</sup></p>			<p><b>New</b> <b>Revela Joint</b> Code: 0634 MS Polymer Crystal Sealant 290 ML = ± 8m<sup>2</sup> (tiles) ± 30m<sup>2</sup> (panel)</p>			

Full details on [gerflor.com](http://gerflor.com)

# Wall coverings

## Mural Ultra Design / Mural Club / Mural Calypso

### Mural Ultra Design

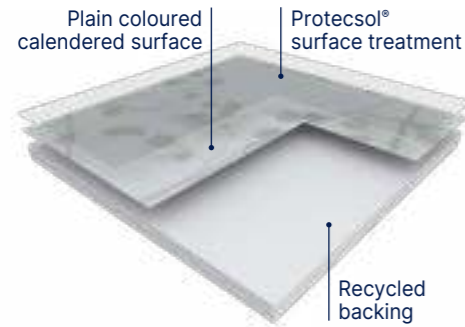

**MURAL ULTRA DESIGN** is a 2m width flexible wall covering vinyl sheet which has a thickness of 1.5mm for an extended durability. Fully resistant to impact (EN 259), **MURAL ULTRA DESIGN** acts as a buffer against damage from beds, trolleys, indoor motorized vehicles and other transportation systems. It is therefore ideal for use as a cladding in large public buildings such as hospitals, care institutions, dental and veterinary surgeries, schools, clean rooms, stores and supermarkets, warehouse and storage areas.

It is made of a 0.10mm printed design layer and a 1.4mm **coloured** resistance layer which will ensure a perfect welding aspect. It has a **B-s2,d0** fire classification (EN 13501-1) which complies with most European fire regulations.

According to ISO 22196, **MURAL ULTRA DESIGN** has anti-bacterial activity against E. coli, S. aureus and MRSA of 99% after 24h00. It is made of a coloured backing which comprises up to **30%** recycled products. It is 100 % recyclable, and the components are 100% compliant with Reach

**MURAL ULTRA DESIGN** benefits from the ProtecSol® surface treatment which ensures easy maintenance (EN 233) and avoids staining of chemical products (EN ISO 26987) used in healthcare like iodine alcohol, Betadine, eosin and antibacterial hand gel. It is also resistant to decontamination (class 3 according to ISO 14644-1). The joints are hot-welded to ensure perfect water-tightness.

**MURAL ULTRA DESIGN** can be welded with 2mm flooring to ensure a perfect hygiene by avoiding gaps.

### Mural Club

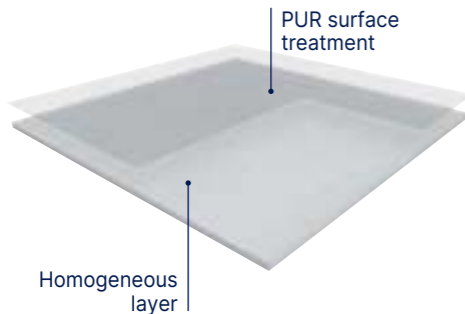

**MURAL CLUB** is a homogeneous wall covering in 2 m width roll and with a B-s2,d0 fire classification. It is designed to be a permanent wall covering. It is hot welded with CR40 welding rods for better hygiene. It is made of calendered layer with colour throughout the whole thickness for a nicer aspect of the welding. This layer comprises at least 10% of recycled products. It does not contain any CMR 1 & 2 component and is 100% compliant with REACH. It is 100% recyclable.

**MURAL CLUB** benefits from a **PUR** surface treatment which provides good resistance to chemical products and makes maintenance easier.

According to ISO 22196, **MURAL CLUB** has **anti-bacterial activity** against E. coli, S. aureus and MRSA of 99% after 24h. Full resistant to impact, it acts as a buffer against damage from beds, trolleys and indoor motorized vehicles and other transportation systems. **MURAL CLUB** is fully impact resistant and is therefore ideal for use as a cladding in large public buildings such as hospitals care institutions dental and veterinary surgeries, clean rooms, stores and supermarkets, warehouse and storage areas.

### Mural Calypso

See page 252

- Easily seam welded to produce continuous surfaces.
- Create a safe and hygienic environment.
- Flexible and easy to cover.
- Ideal for walls and ceilings.
- Recyclable and Eco responsible.

			Mural Ultra Design	Mural Club	Mural Calypso
<b>Description</b>					
Total thickness	EN ISO 24346	mm	1.5	1.00	0.92
Thickness of transparent decorative layer	-	mm	0.10	-	0.10
Thickness of resistance layer	-	mm	1.4	1.00	-
Weight	EN ISO 23997	g/sqm	2450	1780	1610
Width/Length of sheet	EN ISO 24341	cm/ml	200 / 21	200 / 30	200 / 30
Phthalate free	-	-	OK	OK	OK
<b>Classification</b>					
Product specification	-	-	EN 259-1	EN 259-1	EN 259-1
Fire rating	EN 13501-1	class	B-s2,d0	B-s2,d0	B-s2,d0
<b>Performances</b>					
Colour fastness	EN ISO 105-B02	degree	≥ 6	≥ 6	≥ 6
Surface treatment	-	-	ProtecSol®	PUR	-
Chemical products resistance <sup>(1)</sup>	EN ISO 26987	-	OK	OK	OK
Cleanability	EN 233	-	Washable and brushable	Washable and brushable	Washable and brushable
Emission of particles	ISO 14644-1	class	Class 3	-	-
Resistance to impacts	EN 259-2	-	No visible bursting or cracking	-	-
Scratch resistance	NF EN 14565 annex A	-	No visible deterioration	-	-
Determination of flexibility	EN ISO 24344	-	No damage, no cracking	-	-
Resistance of welded joints	EN 684	N/50mm	≥ 250	-	-
<b>Environment</b>					
Recycled content (average)	-	%	20	18	19
Recyclability	-	%	100	100	100
<b>Health</b>					
TVOC after 28 days	ISO 16516	µg/ m <sup>3</sup>	<10	< 100	<100
Anti-bacterial activity (E. coli - S. aureus - MRSA) <sup>(2)</sup>	ISO 22196	-	> 99% inhibits growth	> 99% inhibits growth	> 99% inhibits growth
<b>CE marking</b>					
			EN 15102	OK	

(1) Regarding the resistance to chemicals, please download the corresponding leaflet from our website.  
 (2) The implementation of an effective cleaning regime is the most important defence against infection.

# Wall coverings

## Mural Ultra Design



Bs2d0

Protecsol®



100% recyclable

### IN STOCK

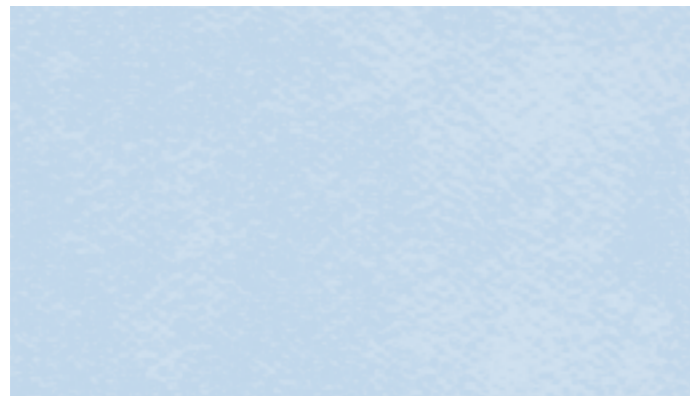

8408 Skyline  
Ⓢ

^ Scale 1



8408 Skyline



8011 Lichen  
Ⓢ



8744 Nordic Milk  
Ⓢ



8309 Lotus  
Ⓢ



8002 Bamboo Lotus  
Ⓢ

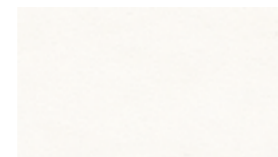

8611 Snow  
Ⓢ



8000 Bamboo Snow Pearl  
Ⓢ

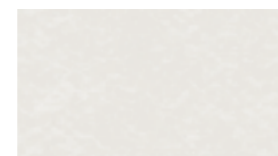

8711 Ice  
Ⓢ

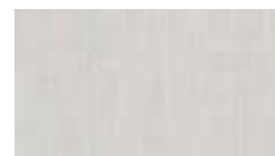

8740 Fabric Silk  
Ⓢ

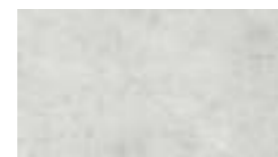

8721 Manhattan Mist  
Ⓢ

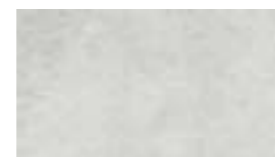

8010 Haze  
Ⓢ



8005 Blossom Snow Pearl  
Ⓢ

### ON DEMAND

Minimum order quantity 500sqm



7025 Arty Beige  
Ⓢ

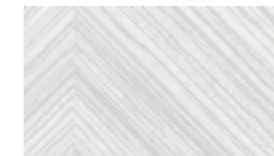

7026 Arty Grey  
Ⓢ



7311 Cloud Linen  
Ⓢ



7017 Cloud Pink  
Ⓢ



7019 Cloud Terra  
Ⓢ

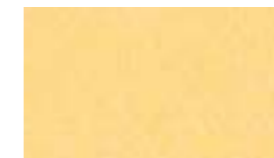

7201 Cloud Moonlight  
Ⓢ



7022 Envol Snow Green\*  
Ⓢ



7023 Envol Snow Skyline\*  
Ⓢ



7013 Ginko Snow Gold\*  
Ⓢ



7014 Ginko Snow Green\*  
Ⓢ



7015 Tropic Skyline  
Ⓢ

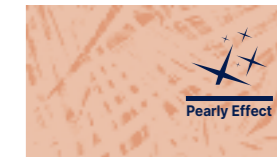

7016 Tropic Terra Copper  
Ⓢ

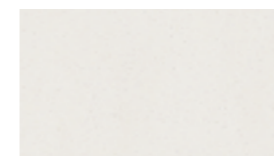

7020 Uni Ice  
Ⓢ

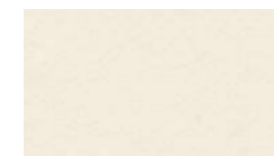

7021 Uni Lotus  
Ⓢ



7027 Verona  
Ⓢ



7024 Venice  
Ⓢ

# Wall coverings

## Mural Club

 **PUR**  **100% recyclable**

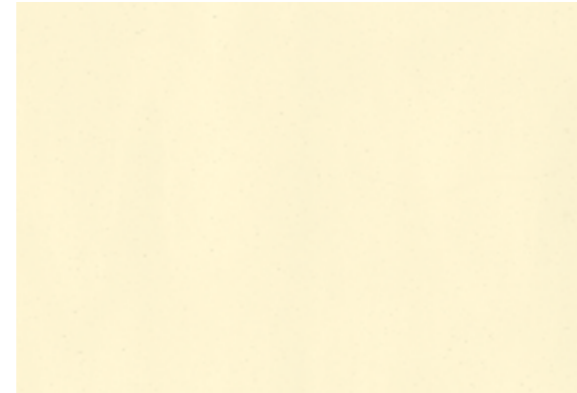

0005 Yellow  ^ Scale1



0006 Grey 

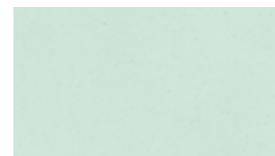

0004 Green 



0003 Sand 



0007 Blue 



0001 White 

## Mural Calypso (See page 252)

 **Bs2d0**  **100% recyclable**





## Fast Track - High Traffic Tiles

pages 212-233

- 216. GTI®**
  - 216. GTI® Max
  - 216. GTI® Pure
  - 220. GTI® EL5
- 224. Attraction®**
- 230. Design tile**
- 232. R-tile**

# Fast Track - High Traffic Tiles

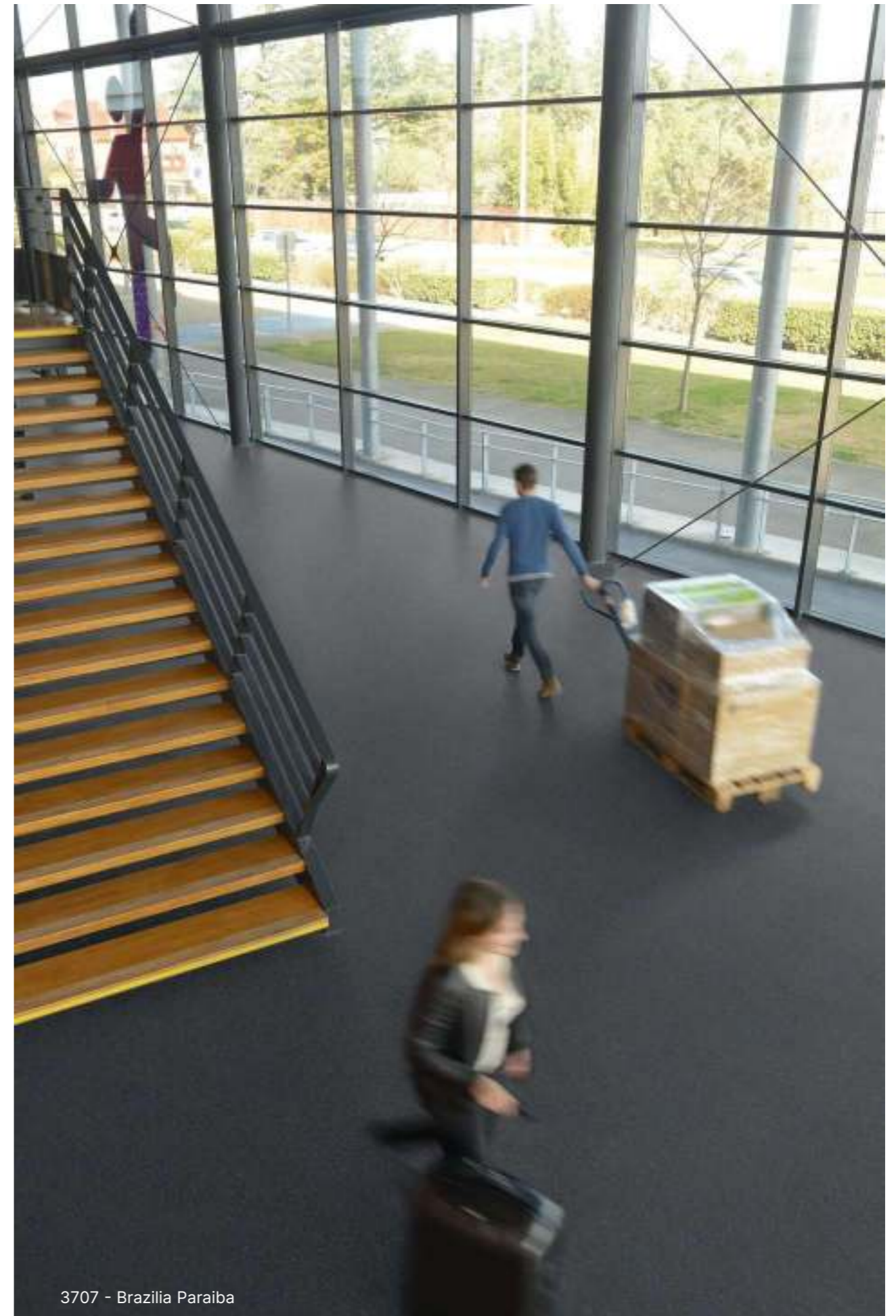
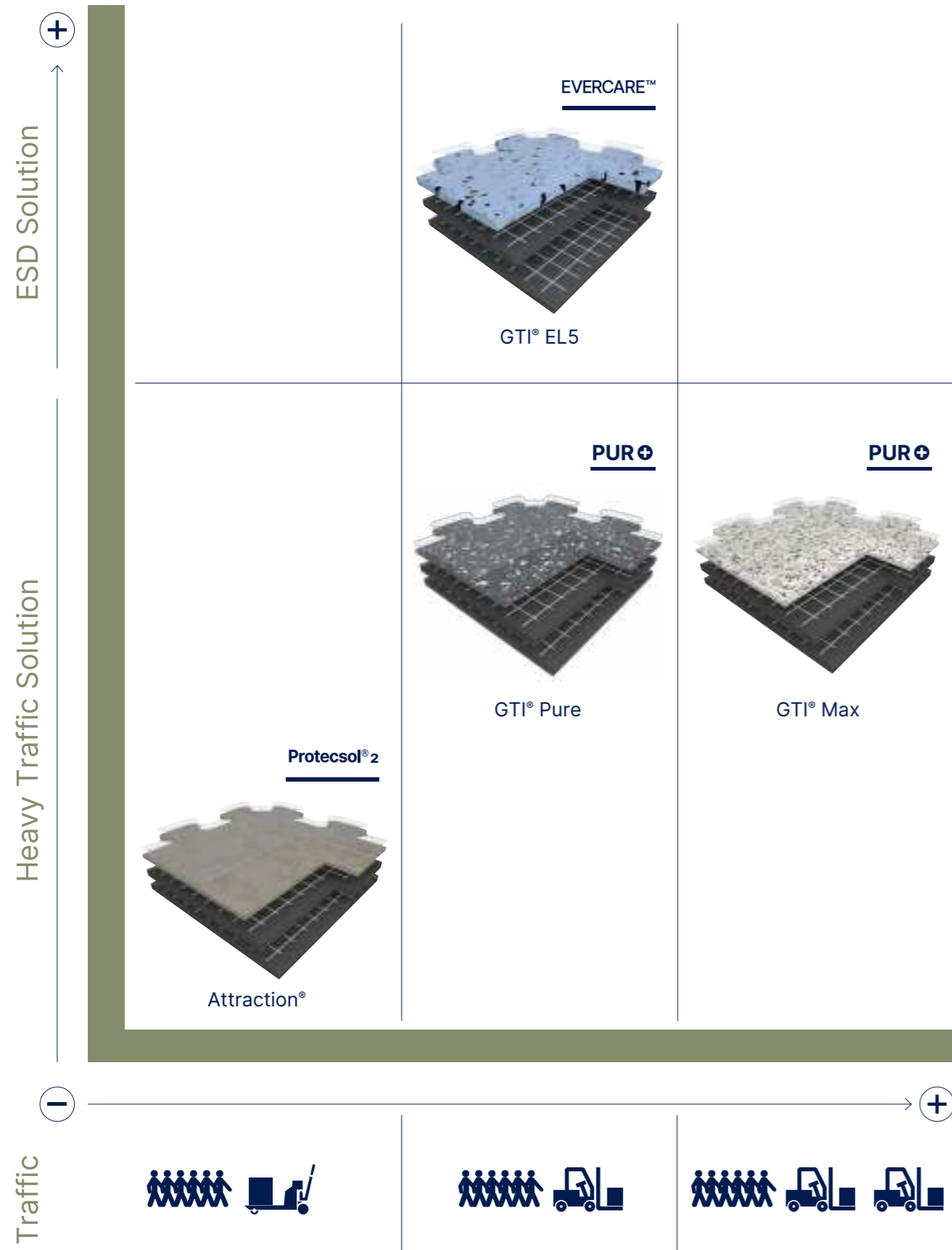

# Fast Track - High Traffic Tiles

## GTI® Max - GTI® Pure

### GTI® Max Connect & Cleantech

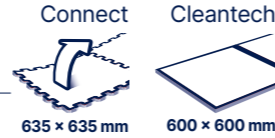

#### GTI® Max Connect

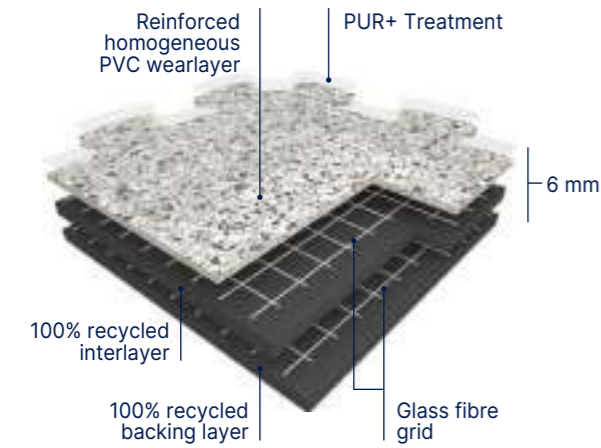

#### GTI® Max Cleantech

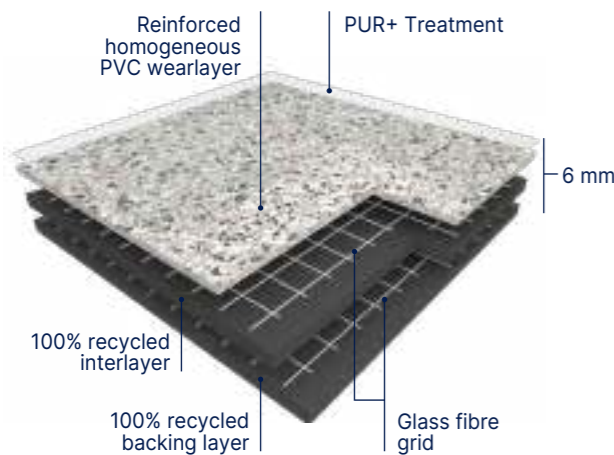

### GTI® Pure Connect

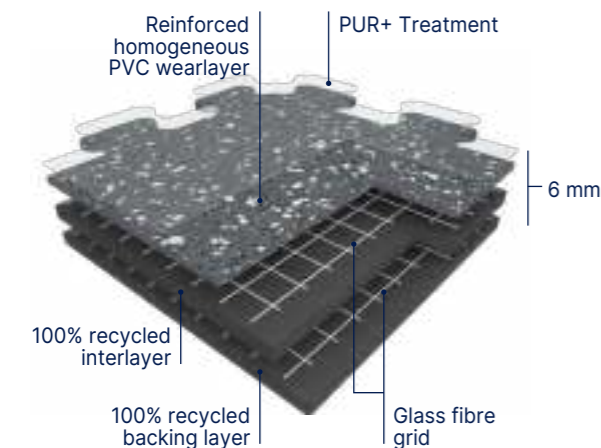

**GTI® Max** is a multi-layered interlocking looselay vinyl tile with polyurethane treatment (**PUR+**), 6 mm thick with a dovetail joint for the **Connect** configuration and with welded joints for the **Cleantech** configuration.

GTI® is manufactured by Gerflor using a continuous high pressure process, abrasion group T. The **GTI® Max** wearlayer is reinforced by specific oblong fillers that offers an outstanding resistance to traffic.

**GTI® Max** is reinforced with 2 glass fibre grids on either side of an intermediate pressed homogeneous layer.

**GTI® Max** backing is a 4 mm thick black pressed homogeneous sheet, its surface is a coloured and reinforced homogeneous sheet 2 mm thick. The product is 100% recyclable.

**GTI® Max** is made with a phthalate free plasticizer.

**GTI® Access** are ramps that provide continuity between the tile and the existing floor.

**GTI® Corner** enable covering of inaccessible corners or finishing central patterns.

**GTI® Pure** is a multi-layered interlocking looselay vinyl tile with polyurethane treatment (**PUR+**), 6 mm thick with a dovetail joint for the **Connect** configuration.

**GTI® Pure** is manufactured by Gerflor using a continuous high pressure process, abrasion group T. The **GTI® Pure** wearlayer is a Pure vinyl homogeneous wear layer with no filler, incorporating very densely pressed coloured chips and without any transparent wear layer. It offers an outstanding abrasion and scratch resistance and an high resistance to traffic.

**GTI® Pure** is reinforced with 2 glass fibre grids on either side of an intermediate pressed homogeneous layer.

**GTI® Pure** backing is a 5 mm thick black pressed homogeneous sheet, its surface is a colored and reinforced homogeneous sheet 1 mm thick. The product is 100% recyclable.

**GTI® Pure** is made with a phthalate free plasticizer.



- Resistant to heavy traffic
- Fast renovation: can be installed over existing floorcovering
- No subfloor preparation, no adhesive and no production stop (no loss of money)

- Polyurethane surface treatment **PUR+** for ease of maintenance
- 6 Standard logos: Mix and match colours to create corners and walkways

	GTI® Max		GTI® Pure	
<b>Description</b>				
Total thickness	EN ISO 24346	mm	6	6
Wearlayer thickness	EN ISO 24340	mm	2	1
Weight	EN ISO 23997	g/m <sup>2</sup>	9365	8930
Size	EN ISO 24342	mm	635 × 635 Connect 600 × 600 Cleantech (without dovetail) <sup>(1)</sup>	635 × 635 Connect
<b>Classification</b>				
Norm / Product specification	-	-	EN ISO 10582	EN ISO 10582
European classification	EN ISO 10874	class	34-43	34-43
Fire rating	EN 13501-1	class	Bfl-s1	Bfl-s1
Static electrical propensity	EN 1815	kV	< 2	< 2
Slip resistance wet: ramp test with oil	EN 16165:2021 – Appendix B (DIN 51 130)	class	R10	R10
Pendulum test	BS7976	-	Concrete emboss <sup>(2)</sup> : +36 PTV	Rice emboss <sup>(2)</sup> : Soft emboss <sup>(2)</sup> -
<b>Performances</b>				
Wear resistance	EN 660.2	mm <sup>3</sup>	≤ 2.0	≤ 2.0
Wear group	-	group	T	T
Type Binder content	EN ISO 10582	type	I	I
Dimensional stability	EN ISO 23999	%	≤ 0.15	≤ 0.15
Residual indentation	EN ISO 24343-1	mm	≤ 0.10	≤ 0.10
Castor chair test (type W)	ISO 4918	-	OK	OK
Shore Hardness	EN ISO 868	H <sub>D</sub>	≥ 55	-
Shifting resistance	CAHIER CSTB 3562	N/mm <sup>2</sup>	≥ 30	-
Thermal conductivity	EN ISO 10456	W/(m.k)	0.25	0.25
Colour fastness	EN ISO 105-B02	degree	≥ 6	≥ 6
Surface treatment	-	-	PUR+	PUR+
Chemical products resistance	EN ISO 26987	-	OK	OK
<b>Environment</b>				
Recycled content (average)	-	%	59	71
Recyclability	-	%	100	100
EPD	-	-	Available	Available
<b>Health</b>				
TVOC after 28 days	ISO 16000-6	microgram/m <sup>3</sup>	< 10	< 10
Certification	-	-	Floorscore®	Floorscore®
<b>CE marking</b>				
CE	EN 14041			

(1) Available upon request

(2) +36 PTV only for 7 references GTI® Max: Ermelino - Ora - Bora - Libeccio - Grecale - Sirocco - Tramontana

#### GTI® LOGOS



0001 Caution 0002 Forklift 0006 Pedestrian 0003 Arrow 0005 No entry 0004 Stop

# Fast Track - High Traffic Tiles

GTI® Max - GTI® Pure



## Rice Emboss

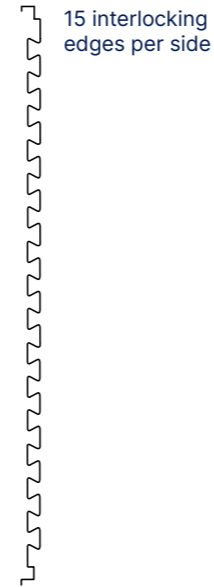
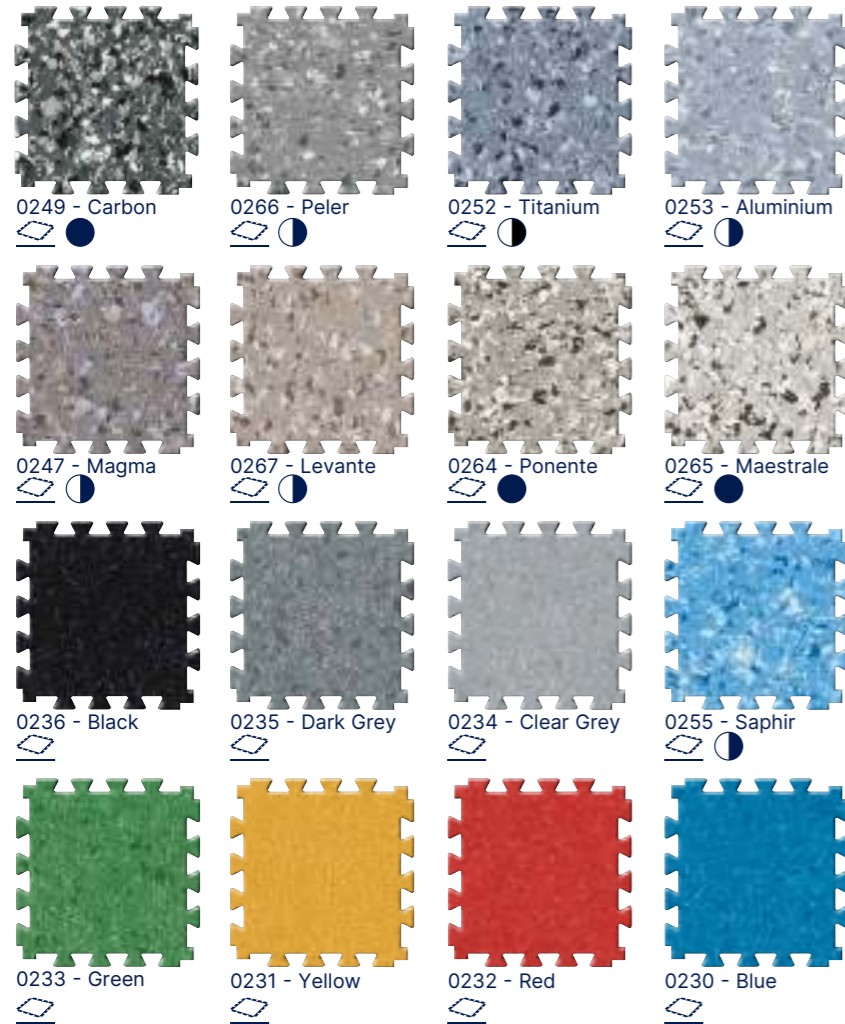

## Concrete Emboss

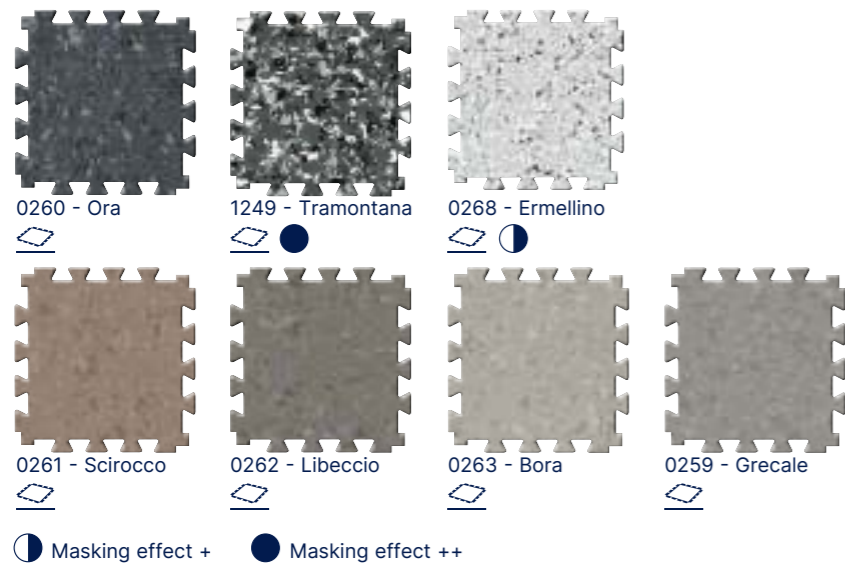

On order Moq: 500 sqm

All these colours are available in GTI® MAX CLEANTECH. For more details please contact your Gerflor representative.

GTI® Max - GTI® Pure



## Soft Emboss\*

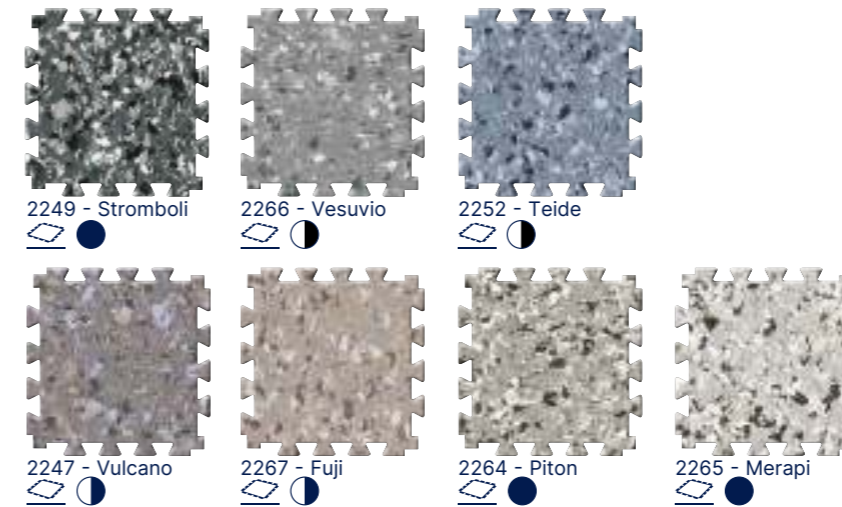

\*On order Moq: 500 sqm

## GTI® Pure



## Soft Emboss\*



\*On order Moq: 500 sqm

● Masking effect +   ● Masking effect ++

## Accessories GTI® Max - GTI® Pure

Aluminium ramp 5-6 mm



Aluminium Ramp 5-6 mm / Ref. 0505 + Aluminium Corner 5-6 mm / Ref. 1513 See page 346

High traffic pvc Ramp 6 mm



Ref. 0500 See page 347

Entrance Mat for GTI®



Romat GT - Ref. 1719



Esplanade 9000 - Ref. 1700

Corner & Access



GTI® ACCESS 635 x 320 mm



GTI® CORNER 320 x 320 mm

For more information, please refer to our GTI® MAX brochure.

# Fast Track - High Traffic Tiles

## GTI® EL5

### GTI® EL5 Connect & Cleantech

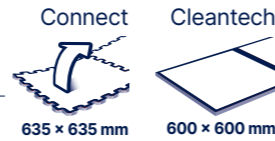

#### GTI® EL5 CONNECT

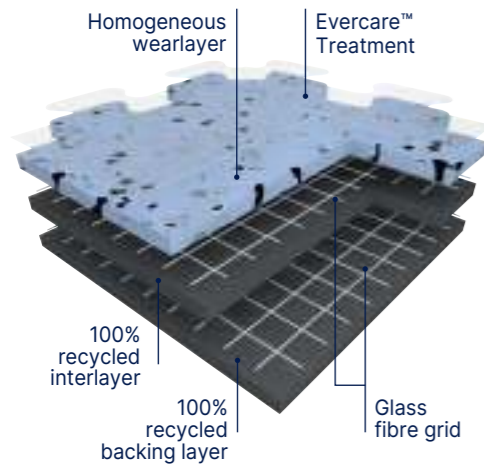

**GTI® EL5 Connect is a multi-layered looselay vinyl tile, 6 mm thick,** reinforced with 2 glass fibre grids. GTI® EL5 Connect tiles can be installed using interlocking system with dove tails.

**GTI® EL5 Cleantech is a multi-layered looselay vinyl tile, 6 mm thick,** reinforced with 2 glass fibre grids. GTI® EL5 Cleantech is available in **square format with welded joints** for clean environments and watertight systems requirements.

**GTI® EL5** wearlayer is 2 mm vinyl homogeneous manufactured with continuous high pressure process, abrasion group P. It offers an outstanding resistance to traffic.

This floorcovering is treated with **Evercare™** technology: the latest improvements in polyurethane surface treatment obtained by UV laser cross-linking. Evercare™ offers **easy maintenance and resistance against staining** of chemical products used in healthcare like betadine, eosin or anti-bacterial hand gel; **and decontamination protocols.**

This treatment has excellent maintenance characteristics; it requires no wax for life!

The carbon encapsulated granules throughout its full thickness and the **conductive backing** and **conductive surface treatment** ensure optimal and consistent conductive properties throughout its full life expectancy.

•  $5 \times 10^4 \leq Rt \leq 10^6$  according to **EN 1081**

It has permanent antistatic properties.

• **< 2000 V** according to **EN 1815**

**The product is non-emissive of volatile organic compounds with < 10 microgram/m³ (TVOC after 28 days ISO 16000-6).**

#### GTI® EL5 CLEANTECH

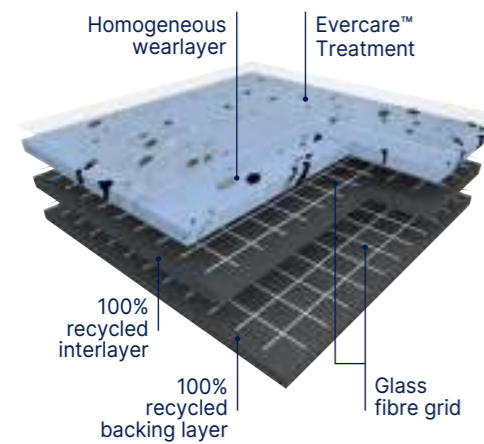

#### Complementary Finishes

GTI® EL5 Connect		GTI® EL5 Cleantech	
		2715	Access
2717	Access	2716	Corner
		2722	Conductive Welding Rods



#### Connect

- Fast Installation
- Resistance to heavy traffic

#### Cleantech

- Watertight System (hot welding)
- Resistance to heavy traffic

#### GTI® EL5

Description			
Total thickness	EN ISO 24346	mm	6
Wearlayer thickness	EN ISO 24340	mm	2
Weight	EN ISO 23997	g/m²	9240
Size	EN ISO 24342	mm	635 x 635 (Connect) 650 x 650 (Cleantech)
Classification			
Norm / Product specification	-	-	EN ISO 10582
European classification	EN ISO 10874	class	34-43
Fire rating	EN 13501-1	class	Bfl-s1
Electrical resistance <sup>(1)</sup>	EN 1081	Ohm	$5 \times 10^4 \leq Rt \leq 10^6$
Static electrical propensity	EN 1815	kV	< 2
Slip resistance wet: ramp test with oil	EN 16165:2021 - Appendix B (DIN 51 130)	class	R9
Performances			
Wear resistance	EN 660.2	mm³	≤ 4.0
Wear group	NF 189	group	P
Type Binder content	EN ISO 10582	type	I
Dimensional stability	EN ISO 23999	%	≤ 0.25
Castor chair test (type W)	ISO 4918	-	OK
Shore Hardness	EN ISO 868	H <sub>b</sub>	≥ 90
Thermal conductivity	EN ISO 10456	W/(m.k)	0.25
Colour fastness	EN ISO 105-B02	degree	≥ 6
Surface treatment	-	-	Evercare™
Chemical products resistance	EN ISO 26987	-	OK
Environment			
Recycled content (average)	-	%	43
Recyclability	-	%	100
EPD	-	-	Available
Health			
TVOC after 28 days	ISO 16000-6	microgram/m³	< 10
Certification	-	-	Floorscore®
CE marking			



EN 14041

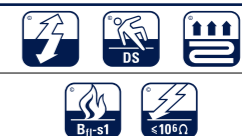

(1) Measured before installation



# Fast Track - High Traffic Tiles

GTI® EL5



GTI® Cleantech - 0354 Blue



Removable R9 Evercare™

GTI® EL5 CONNECT



635 × 635 mm

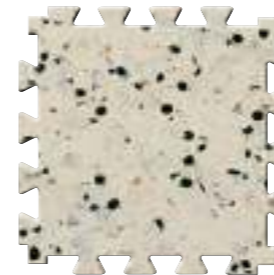

0353 Beige



0350 Light Grey

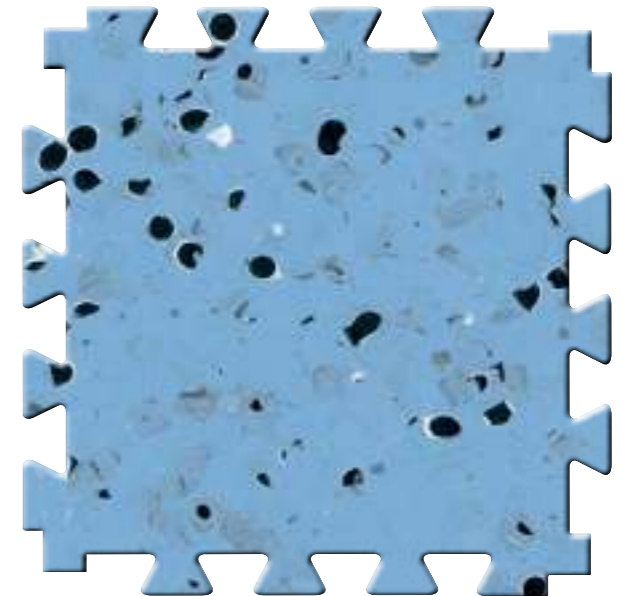

0354 Blue

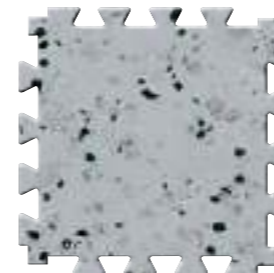

0352 Grey



0351 Black

^ Scale 1

GTI® EL5 CLEANTECH



Removable R9 Evercare™

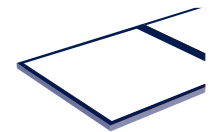

650 × 650 mm

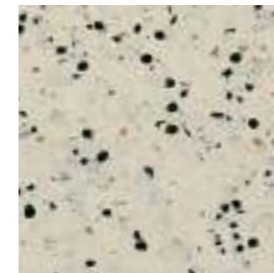

0353 Beige

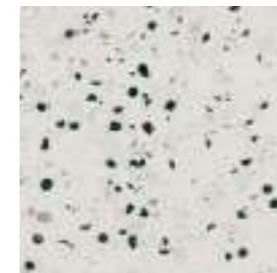

0350 Light Grey

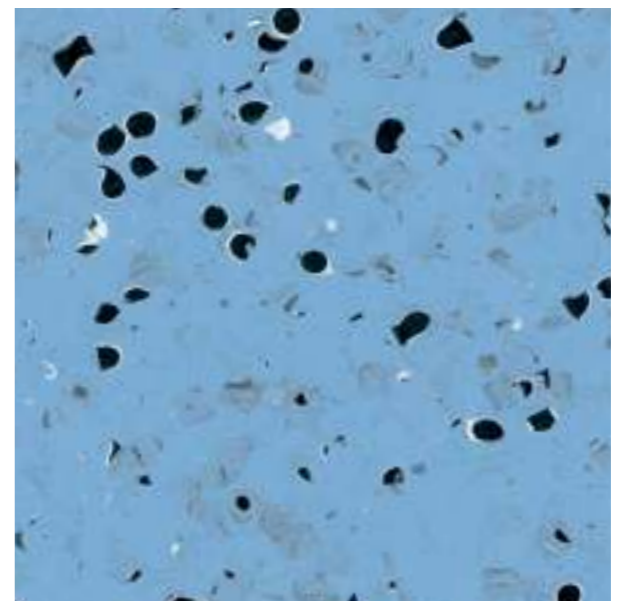

0354 Blue

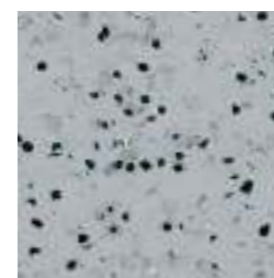

0352 Grey

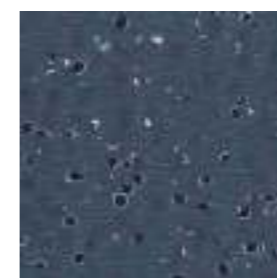

0351 Black

^ Scale 1

# Fast Track - High Traffic Tiles

Attraction®

Attraction® Connect & Cleantech

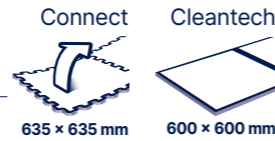

Attraction® connect

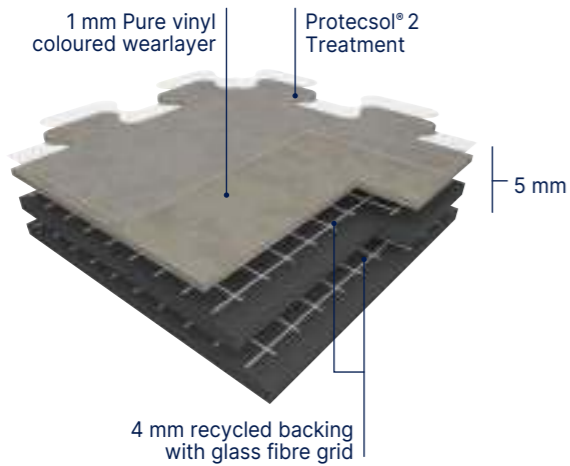

Attraction® is a semi-flexible tile constructed by compacting, at high temperature and over 3000 T, a 4 mm recycled backing and a 1 mm **Pure vinyl wear layer. This wear layer is incorporating very densely pressed coloured chips, with a mat finishing and without a transparent wear layer.** The product comprises a compact backing which is pressed and reinforced with two glass fibre grids.

Attraction® has a unique dovetail joint which allows fast loose lay installation and replacement.

Attraction® is treated with **Protecsol® 2**, a surface treatment obtained by UV laser crosslinking.

This **Protecsol® 2** ensures easy maintenance and eliminates permanently the need for acrylic emulsion (metallisation). It avoids staining of chemical products used in healthcare like iodine alcohol, Betadine, eosin and anti-bacterial hand gel.

It has a Bfl-s1 fire classification in accordance with standard EN 13501-1. The products emission rate of volatile organic compounds is **< 10 microgram/m³ (TVOC after 28 days – ISO 16000-6)**.

It is made with a phthalate free plasticizer.

It is made of 100% controlled recycled materials.

It does not contain any heavy metals or CMR 1&2 and they are 100% compliant with REACH.

It is 100% recyclable and made with up to 80% recycled content.

Attraction® cleantech

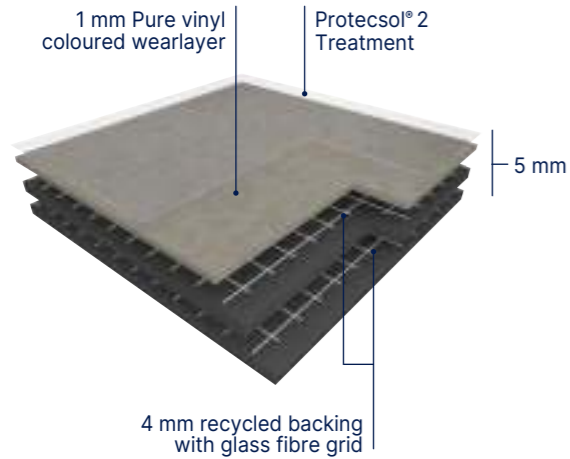

Attraction®



The Taralay Premium range in the looselay Attraction® format for an easy and longlasting renovation!

- Fast track and easy installation
- No immobilisation of the premises and no loss of turnover
- Little or no subfloor preparation
- Low maintenance cost: UV cured polyurethane Protecsol® 2 treatment

Attraction®			
<b>Description</b>			
Total thickness	EN ISO 24346	mm	5.00
Wearlayer thickness	EN ISO 24340	mm	1.00
Weight	EN ISO 23997	g/m²	7460
Size	EN ISO 24342	mm	635 × 635 Connect 600 × 600 Cleantech (without dovetail) <sup>(1)</sup>
<b>Classification</b>			
Norm / Product specification	-	-	EN ISO 10582
European classification	EN ISO 10874	class	34-43
Fire rating	EN 13501-1	class	Bfl-s1
Static electrical propensity	EN 1815 IEC 61340-4-5	kV V	< 2
Slip resistance wet: ramp test with oil	EN 16165:2021 – Appendix B (DIN 51 130)	class	R10
<b>Performances</b>			
Wear resistance	EN 660.2	mm³	≤ 2.0
Wear group	-	group	T
Type Binder content	EN ISO 10582	type	I
Dimensional stability	EN ISO 23999	%	≤ 0.15
Residual indentation	EN ISO 24343-1	mm	≤ 0.10
Castor chair test (type W)	ISO 4918	-	OK
Thermal conductivity	EN ISO 10456	W/(m.k)	0.25
Colour fastness	EN ISO 105-B02	degree	≥ 6
Surface treatment	-	-	Protecsol® 2
Chemical products resistance	EN ISO 26987	-	OK
<b>Environment</b>			
Recycled content (average)	-	%	69
Recyclability	-	%	100
EPD	-	-	Available
<b>Health</b>			
TVOC after 28 days	ISO 16000-6	microgram/m³	< 10
Certification	-	-	Floorscore®
Anti-bacterial activity (E. coli - S. aureus - MRSA) <sup>(2)</sup>	ISO 22196	-	> 99 % inhibits growth / ne favorise pas la prolifération
Anti-viral activity (human coronavirus 229E)	ISO 21702	-	99.7% after 2h
<b>CE marking</b>			



EN 14041

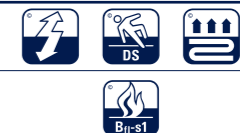

(1) Available upon request.

(2) The implementation of an effective cleaning method is the best defence against infection.

# Fast Track - High Traffic Tiles

Attraction®



**Removable R10 ProtecsoI® 2**

**100% recyclable**

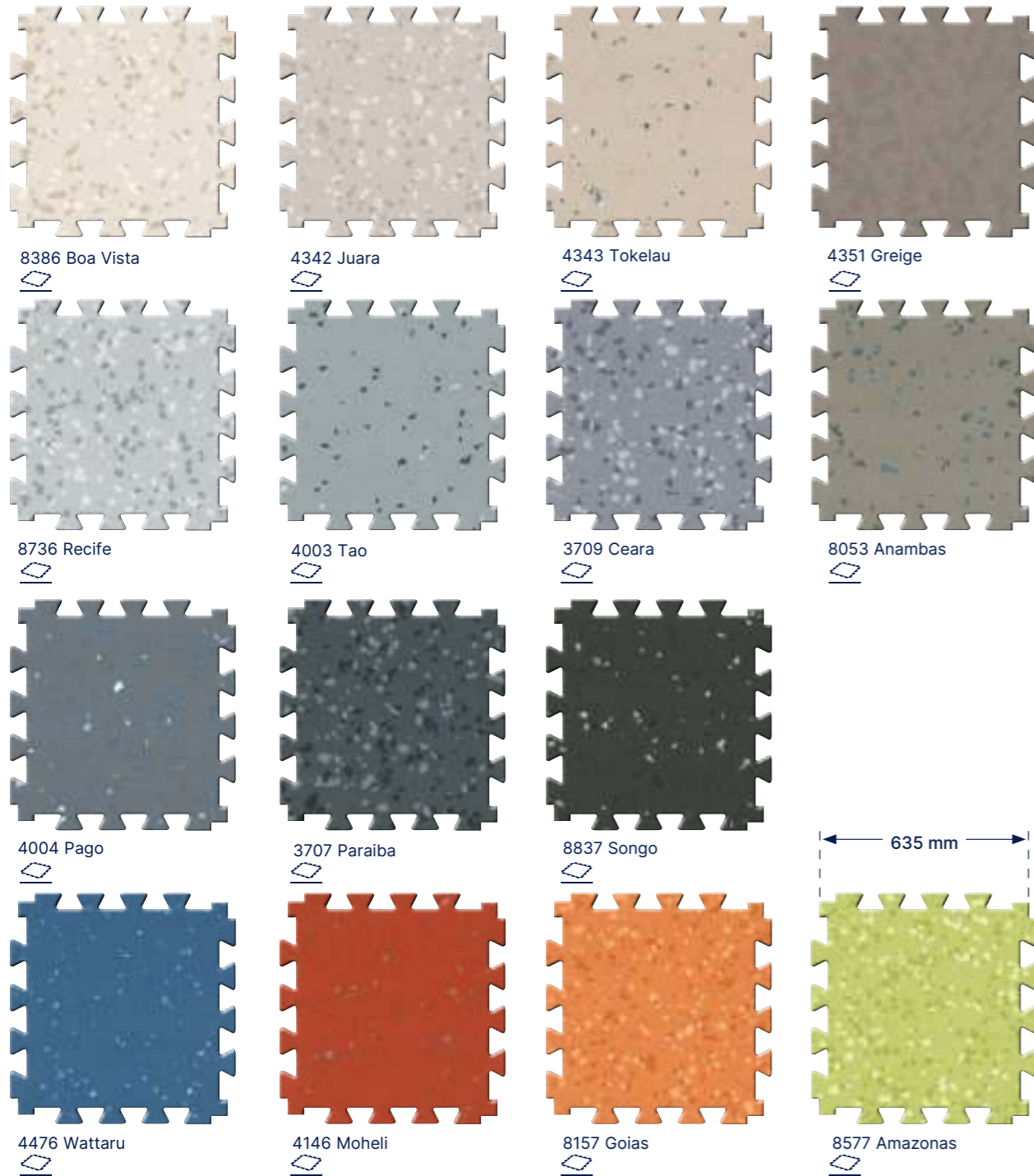

15 interlocking edges per side

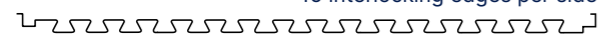

All these colours are available in **ATTRACTION® CLEANTECH**. For more details please contact your Gerflor representative.

# Attraction® - Neopolis



**Removable R10 ProtecsoI® 2**

**100% recyclable**

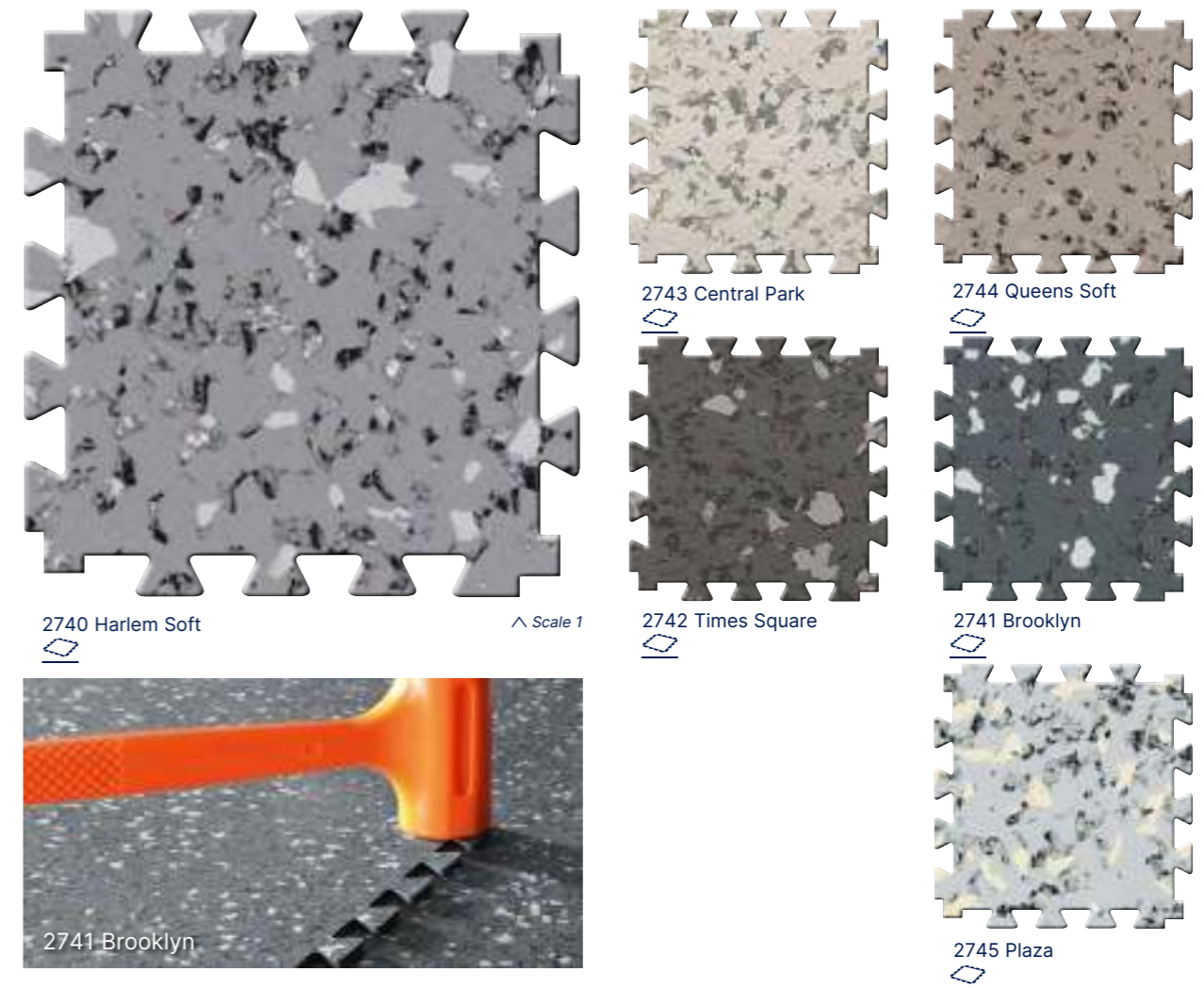

## Accessories Attraction®

Aluminium ramp srewed - 5-6 mm



0505



1513

Entrance Mat for Attraction®



Esplanade 9000 - Réf. 1700

Corner & Access



**ATTRACTION ACCESS**  
635 x 320 mm

**ATTRACTION CORNER**  
320 x 320 mm

See page 346

For more information, please refer to our Attraction® brochure.

# Fast Track - High Traffic Tiles

## Design Tile - R-Tile

### Design Tile



**Design Tile** is a synthetic, decorative, flexible, antistatic, abrasion group T floor covering. It consists in a multi-layered tile with a 0,70 mm thick transparent wear layer and a printed film on an injected molded backing. The overall thickness is 7,8 mm.

**Design Tile** is an interlocking hidden dovetail loose lay tiles with grout edges. The resistance to use (commercial / industrial use) of 34 / 43 according to EN-ISO 10874 and has Bfl -s1 class for smoke emission according to EN 13501-1.

**Design Tile** is made from ultra-stable 100% recyclable material with up to 80% of recycled content. It is REACH compliant. The product emission rate of organic compounds is < 100 micrograms/m<sup>3</sup> (TVOC <28 days - ISO 16000-6).

### R-Tile



**R-Tile** is a synthetic, flexible, antistatic, floor covering. It consists in an injected molded backing. The overall thickness is 5, 7 or 9 mm.

**R-Tile** is an interlocking dovetail loose lay tile. The resistance to use (commercial / industrial use) of 34 / 43 according to EN-ISO 10874 and has Bfl -s1 class for smoke emission according to EN 13501-1.

**R-Tile** is made from ultra-stable 100% recyclable material with up to 80% of recycled content. It is REACH compliant. The product emission rate of organic compounds is < 100 micrograms/m<sup>3</sup> (TVOC <28 days - ISO 16000-6).

### Do not forget the finishes & tools



**Aluminum Ramp**  
Screwed - 2,5m  
Code: 0663 with Insert (Black, Light Grey, Dark Grey) Code: 4096



**Diminishing profile - 2m**  
Code: 0490



**Entrance mat**  
Esplanade 9000  
Code: 1700



**Anti Bounce Mallet**  
Code: 5951

**PVC Ramp**  
2m - Code: 7032



#### Design Tile:

- Ceramic tile look
- Adhesive free
- Rolling traffic compliant\*
- Renovation over ceramic
- Circularity: 100% re-usable or re-cyclable

\* Conditions specified in installation guidelines

#### R-Tile:

##### Performance

- Withstand Mechanical traffic
- 10 colors available in 5 mm, 7 mm, 9 mm

##### Easy Installation

- Adhesive Free Interlocking system: Easy to remove and reuse
- Minimal subfloor preparation: easy to install

##### Safety & Well being

- R10 Slip resistance
- Walking comfort

	Design Tile		R-Tile			
<b>Description</b>						
Total thickness	EN ISO 24346	mm	7.8	5	7	9
Wearlayer thickness	EN ISO 24340	mm	0.70	-	-	-
Weight	EN ISO 23997	g/m <sup>2</sup>	12 000	7000	9200	12800
Size	EN ISO 24342	mm	457 × 457 / 614 × 614	503 × 503		
<b>Classification</b>						
Norm / Product specification	-	-	EN ISO 10582	EN ISO 10581		
European classification	EN ISO 10874	class	34-43	34-43		
Fire rating	EN 13501-1	class	Bfl-s1	Bfl-s1		
Static electrical propensity	EN 1815	kV	< 2	< 2		
Slip resistance wet: ramp test with oil	EN 16165:2021 - Appendix B (DIN 51130)	class	R10	R10		
<b>Performances</b>						
Wear resistance	EN 660.2	mm <sup>3</sup>	≤ 2.0	-		
Wear group	-	group	T	-		
Type Binder content	EN ISO 10582	type	I	I		
Curling	EN ISO 23999	mm	≤ 1	-		
Dimensional stability	EN ISO 23999	%	≤ 0.15	≤ 0.15		
Residual indentation	EN ISO 24343-1	mm	≤ 0.05	≤ 0.10		
Castor chair test (type W)	ISO 4918	-	OK	OK		
Flexibility	ISO 24344 METHOD A	-	-	No cracking		
Shore Hardness	EN ISO 868	H <sub>d</sub>	> 60	≥ 40		
Thermal conductivity	EN ISO 10456	W/(m.k)	0.25	0.25		
Colour fastness	EN ISO 105-B02	degree	≥ 6	≥ 6		
Surface treatment	-	-	PUR+	-		
Chemical products resistance	EN ISO 26987	-	OK	OK		
<b>Environment</b>						
Recyclability	-	%	100	100		
<b>Health</b>						
TVOC after 28 days	ISO 16000-6	microgram/m <sup>3</sup>	< 100	< 100		
<b>CE marking</b>						
CE		EN 14041				
<b>Conditions of use</b>						
Rolling traffic	Frequency	-	-	Occasional (1x per day max.)		
	Type of wheeled traffic	-	-	Manual pallet truck	Electric pallet truck and forklift	
	Max total load	kg	-	600	1500	3000
	Max contact pressure	kg/cm <sup>2</sup>	-	40	60	80

# Fast Track - High Traffic Tiles

## Design Tile

Removable R10 PUR+ 100% recyclable

614 × 614 mm format



1696 Acero Light



1696 Acero Light  
Light grey grout



1695 Manhattan Cloud  
Light grey grout



1698 Marmetta Beige  
Brown grout



1694 Manhattan Dust  
Light grey grout

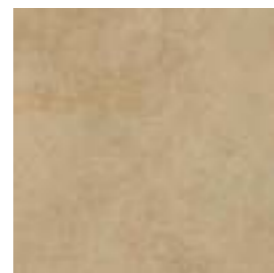

1697 Acero Beige  
Light grey grout



1693 Manhattan Grey  
Dark grey grout



1699 Luberon Grey  
Light grey grout



1692 Manhattan Storm  
Dark grey grout

Removable R10 PUR+ 100% recyclable

457 × 457 mm format



1551 Vintage Sand



1548 Limestone  
Light grey grout



1555 Sandstone  
Light grey grout



1545 Clay  
Dark grey grout



1546 Granite  
Dark grey grout

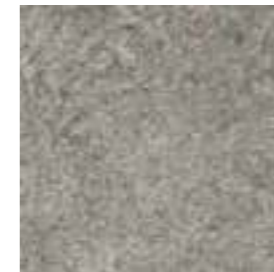

1544 Shalestone  
Dark grey grout

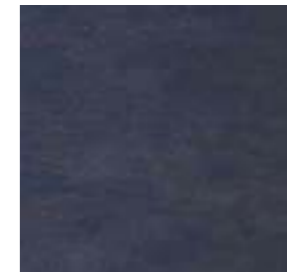

1547 Volcano  
Black grout



1553 Terrazzo Cream  
Dark grey grout

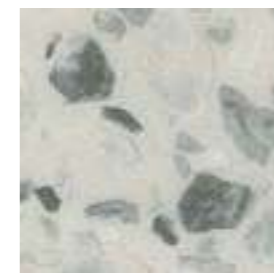

1554 Terrazzo Grey  
Dark grey grout



1549 Polished Concrete  
Light grey grout



1550 Vintage Maple  
Light grey grout

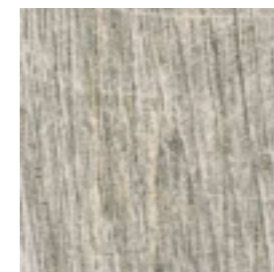

1552 Vintage Ash  
Light grey grout



1551 Vintage Sand  
Brown grout

# Fast Track - High Traffic Tiles

## R-Tile



Removable

R10



100% recyclable



7045 Light Grey / 5005 Blue



7045 Light Grey



7015 Dark Grey



9004 Black



1018 Yellow



5005 Blue



6005 Green



3020 Red



3016 Maroon



1002 Beige

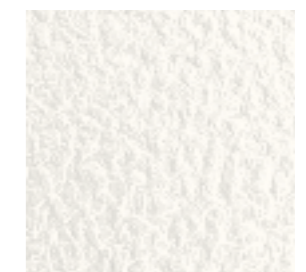

9003 White

Fast Track  
High Traffic  
Tiles



# Technical Solutions

pages 234-253

## 238. EL5 / EL7 Solutions Dissipative & conductive floors

- 240. Dissipative floors
- 240. Mipolam EL7
- 240. Mipolam Robust EL7

- 241. Conductive floors
- 241. Mipolam EL5
- 241. Mipolam Technic EL5  
GTI® EL5 (See page 220)

## 242. Safety Floorings

- 244. Tarasafe Ultra Sparclean®
- 246. Tarasafe Standard - Plus - Super
- 247. Tarasafe H<sub>2</sub>O  
Tarasafe Ultra H<sub>2</sub>O (See page 250)

## 248. Shower System

- 250. Tarasafe Ultra H<sub>2</sub>O
- 251. Tarasafe Design
- 252. Mural Calypso

# Technical solutions

EL5 / EL7  
Solutions

## Dissipative Floors

EN 1081 ( $\Omega$ ):  $10^6 \leq Rt \leq 10^8$



Mipolam EL7

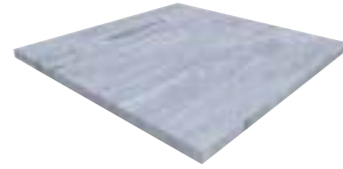

Mipolam Robust EL7

## Conductive Floors

EN 1081 ( $\Omega$ ):  $10^4 \leq Rt \leq 10^6$



Mipolam EL5

EN 1081 ( $\Omega$ ):  $10^4 \leq Rt \leq 10^6$

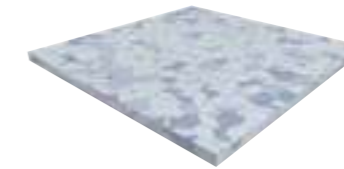

Mipolam Technic EL5

EN 1081 ( $\Omega$ ):  $5 \times 10^4 \leq Rt \leq 10^6$

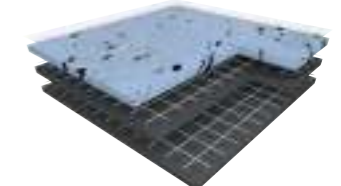

GT1 EL5

Slip Resistant  
Floorings

## SparClean® Treatment



Tarasafe Ultra



Tarasafe Design

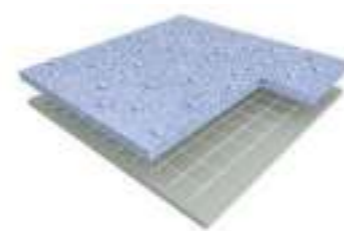

Tarasafe H<sub>2</sub>O

## SparClean® Treatment



Tarasafe Standard

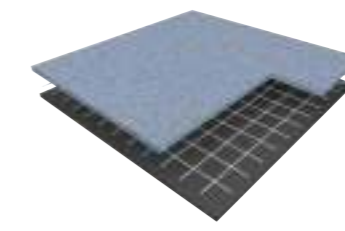

Tarasafe Super

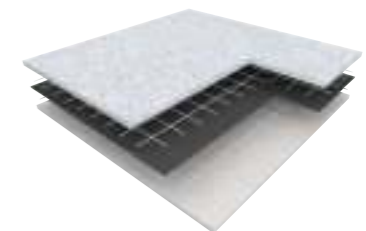

Tarasafe Plus

Shower  
System

## Floorcoverings

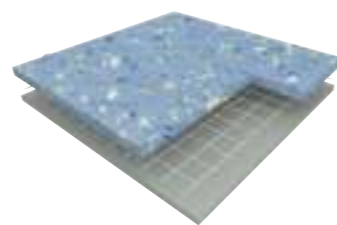

Tarasafe Ultra H<sub>2</sub>O



Tarasafe  
Standard / Ultra / Design

## Wallcoverings

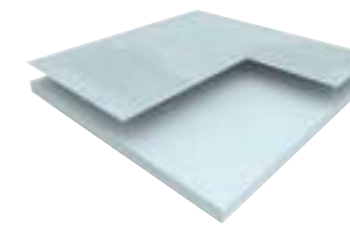

Mural Calypso

Technical  
Solutions

# Technical solutions

## EL5 / EL7 Solutions

### Dissipative floors

#### Mipolam EL7 - Mipolam Robust EL7

##### Mipolam EL7

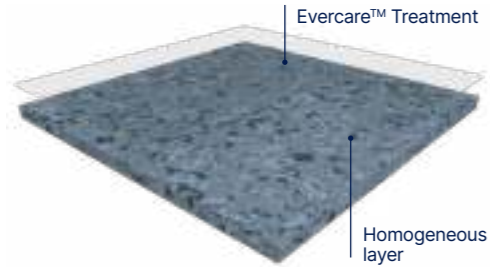

$10^6 \leq Rt \leq 10^8 \Omega$  Evercare™ 100% recyclable

**MIPOLAM EL7** is a dissipative flexible homogeneous vinyl floorcovering available in both sheet and tile form, calendered and compacted and comes in 10 colours. This floorcovering is treated with **EVERCARE™**: the latest improvements in polyurethane surface treatment obtained by UV laser cross-linking. Evercare™ avoids stain of chemical products used in healthcare like Betadine, eosin or anti-bacterial hand gel and increases the durability of the flooring. According to ISO 21702, **MIPOLAM EL7** has **anti-viral activity** against Human Coronaviruses: it reduces the number of virus by 99.7% after 2h. According to ISO 22196, **MIPOLAM EL7** has **anti-bacterial activity** against E. coli, S. aureus and MRSA of 99% after 24h. This treatment has excellent maintenance characteristics; it requires no wax for life! **MIPOLAM EL7** acts as a continuous dissipater  $10^6 \leq Rt \leq 10^8$ . The product has to be grounded with an ESD copper strip (see finishes) to meet its full performance. The product is non-reactive to residual indentation with a value  $\leq 0.02$  mm. The flooring has a binder content type II, is suitable for heavy duty traffic areas and has a Bfl-s1 fire resistance. The product is non-emissive of volatile organic compounds with  $< 10$  microgram/m<sup>3</sup> (TVOC after 28 days ISO 16000-6).

##### Mipolam Robust EL7

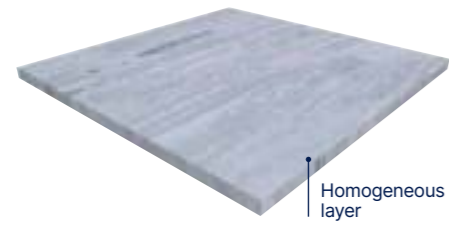

$10^6 \leq Rt \leq 10^8 \Omega$  100% recyclable

**MIPOLAM ROBUST EL7** is a dissipative flexible homogeneous vinyl floorcovering available in both sheet and tile. Calendered and compacted. It acts as a continuous dissipater  $10^6 \leq Rt \leq 10^8$  (EN 1081).

### Conductive floors

#### Mipolam EL5 - Mipolam Technic EL5

##### Mipolam EL5

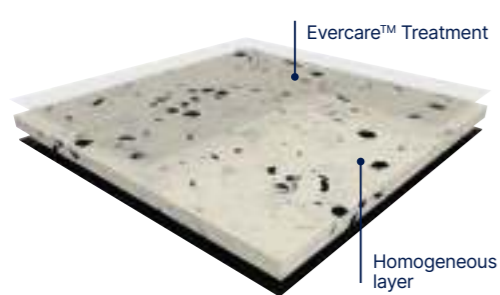

$10^4 \leq Rt \leq 10^8 \Omega$  Evercare™ 100% recyclable

**MIPOLAM EL5** is a conductive flexible homogeneous vinyl floorcovering available in sheet. The 2 mm homogeneous material incorporates carbon encapsulated granules throughout its full thickness. It has a **conductive backing** to ensure optimal and consistent conductive properties throughout its full life expectancy. This floorcovering is treated with **EVERCARE™**: the latest improvements in polyurethane surface treatment obtained by UV laser cross-linking. Evercare™ avoids stain of chemical products used in healthcare like Betadine, eosin or anti-bacterial hand gel and increases the durability of the flooring. According to ISO 21702, **MIPOLAM EL5** has **anti-viral activity** against Human Coronaviruses: it reduces the number of virus by 99.7% after 2h. According to ISO 22196, **MIPOLAM EL5** has **anti-bacterial activity** against E. coli, S. aureus and MRSA of 99% after 24h. This treatment has excellent maintenance characteristics; it requires no wax for life! **MIPOLAM EL5** acts as a continuous conductive  $10^4 \leq Rt \leq 10^8$ . The product has to be grounded with an ESD copper strip (see finishes) to meet its full performance. The product is non-reactive to residual indentation with a value  $\leq 0.02$  mm (EN ISO 24343-1). The flooring complies with the EN ISO 10874 (34-43) offering a binder content type II, is suitable for heavy duty traffic areas and has a Bfl-s1 fire resistance. The product is non-emissive of volatile organic compounds with  $< 10$  microgram/m<sup>3</sup> (TVOC after 28 days ISO 16000-6).

##### Mipolam Technic EL5

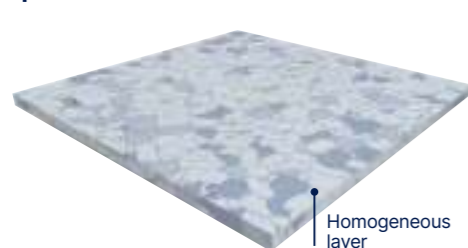

$10^4 \leq Rt \leq 10^8 \Omega$  100% recyclable

**MIPOLAM TECHNIC EL5** is a conductive flexible homogeneous compacted vinyl floorcovering available in tiles. The conductive carbon coated PVC pellets create a perfect conductive network for permanent conductive and antistatic properties throughout its full life expectancy. It acts as a continuous conductive  $10^4 \leq Rt \leq 10^8$  (EN 1081).

100% recyclable

A complete range for Hi-tech applications: electronics and telecommunication areas, computer rooms, operating theatres, radiology...

- Compacted floorcovering for better hygiene, maintenance, and traffic resistance.
- Available in tiles and sheets with specific formats especially adapted to raised floors (608 × 608 mm).

			Mipolam EL7	Mipolam Robust EL7	Mipolam EL5	Mipolam Technic EL5
<b>Description</b>						
Total thickness	EN ISO 24346	mm	2	2	2	2
Weight	EN ISO 23997	g/sqm	3100	3300	2985	3800
Width of sheet	EN ISO 24341	cm	200	200	200	-
Length of sheet	EN ISO 24341	lm	20	20	20	-
Tile size	EN ISO 24342	mm	608 × 608	608 × 608	-	608 × 608
Number of tiles per package	-	-	20	20	-	20
Phthalate free	-	-	OK	OK	OK	OK

<b>Classification</b>						
Norm / Product specification	-	-	EN ISO 10581	EN ISO 10581	EN ISO 10581	EN ISO 10581
European classification	EN ISO 10874	class	34-43	34-43	34-43	34-43
Fire rating	EN 13501-1	class	Bfl-s1	Bfl-s1	Bfl-s1	Bfl-s1
Electrical resistance <sup>(1)</sup>	EN 1081	Ohm	$10^6 \leq Rt \leq 10^8$	$10^6 \leq Rt \leq 10^8$	$10^4 \leq Rt \leq 10^6$	$10^4 \leq Rt \leq 10^6$
Static electrical propensity	EN 1815	kV	< 2	< 2	< 2	< 2
Slip resistance wet	EN 16165:2021 – Appendix B (DIN 51 130)	class	R9	-	R9	-

<b>Performances</b>						
Type Binder content	EN ISO 10581	type	II	II	I	II
Dimensional stability	EN ISO 23999	%	Sheet $\leq 0.40$ Tile $\leq 0.25$	Sheet $\leq 0.40$ Tile $\leq 0.25$	$\leq 0.40$	$\approx 0.25$
Residual indentation (norm)	EN ISO 24343-1		$\leq 0.10$	$\leq 0.10$	$\leq 0.10$	$\leq 0.10$
Residual indentation (average measured value)	EN ISO 24343-1	mm	$\approx 0.02$	$\approx 0.03$	$\approx 0.02$	$\approx 0.03$
Castor chair test (type W)	ISO 4918	-	OK	OK	OK	OK
Thermal conductivity	EN ISO 10456	W/(m.k)	0.25	0.25	0.25	0.25
Colour fastness	EN ISO 105-B02	degree	$\geq 6$	$\geq 6$	$\geq 6$	$\geq 6$
Surface treatment	-	-	Evercare™	-	Evercare™	-
Chemical products resistance <sup>(2)</sup>	EN ISO 26987	-	OK	OK	OK	OK

<b>Health</b>						
TVOC after 28 days	ISO 16000-6	microgram/m <sup>3</sup>	< 10	< 10	< 10	< 10
Certification	-	-	Floorscore®	-	Floorscore®	-
Anti-bacterial activity (E.coli – S. aureus – MRSA) after 24h <sup>(3)</sup>	ISO 22196	-	> 99% inhibits growth	-	> 99% inhibits growth	-
Anti-viral activity (human coronavirus) after 2h <sup>(3)</sup>	ISO 21702	-	> 99.7% virucidal activity	-	> 99.7% virucidal activity	-

<b>CE marking</b>						
	EN 14041					

(1) Measured before installation.

(2) Staining table available upon request.

(3) The implementation of an effective cleaning method is the best defence against infection

**Important:** please refer to Gerflor installation guidelines - [www.gerflor.com](http://www.gerflor.com)

# Technical solutions

Dissipative floors: Mipolam EL7 & Mipolam Robust EL7

## Mipolam EL7



$10^6 \leq Rt \leq 10^8 \Omega$  Evercare™ 100% recyclable



4120 Silver Grey <sup>^</sup> Scale 1



4166 Thistle



4159 Grey Storm

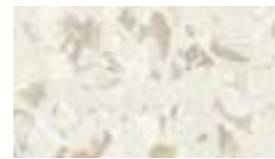

4101 Quartz



4120 Silver Grey



4116 Sapphire



4111 Raffia



4124 Smoked Opal



4110 Violet Grey



4144 Havana Brown



4132 Citrine

## Mipolam Robust EL7



$10^6 \leq Rt \leq 10^8 \Omega$  100% recyclable



0003 Ivory <sup>^</sup> Scale 1



0005 Steel



0013 Pewter



0003 Ivory



0112 Storm



0306 Green



0002 Platinum

Conductive floors: Mipolam EL5 / Technic EL5 / GTI EL5

## Mipolam EL5



$10^4 \leq Rt \leq 10^8 \Omega$  Evercare™ 100% recyclable



0354 Blue <sup>^</sup> Scale 1



0350 Light Grey



0353 Beige



0354 Blue



0352 Grey



0351 Black



0355 Green

## Mipolam Technic EL5



$10^4 \leq Rt \leq 10^8 \Omega$  100% recyclable



0637 Light Blue <sup>^</sup> Scale 1



0635 White



0636 Grey



0637 Light Blue



0640 Beige



0638 Blue



0639 Green

## GTI® EL5

GTI® EL5 (See page 220)



Removable R9 Evercare™ 100% recyclable

# Technical solutions

## Safety Floorings - Tarasafe

### Tarasafe Ultra: Sparclean® Treated

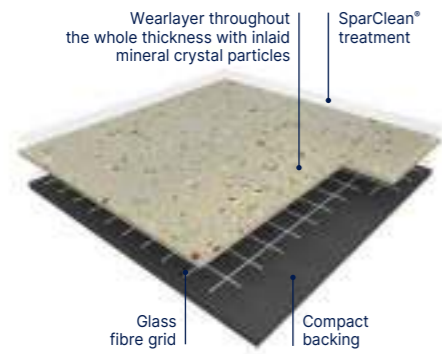

**TARASAFE ULTRA** is a hardwearing safety flooring collection that comprises of a PVC wear layer and deeply inlaid mineral crystal particles (patented) and coloured chips for a decorative design. It is suitable for heavy traffic areas and is ideal for hardworking contract applications. It delivers Safety in Numbers, with a PTV >36+ slip resistance (Dry & Wet), a R10 wet slip resistance rating and >20 Rtm/Rz surface roughness in accordance with HSE guidelines. The revolutionary **SparClean®** surface treatment improves the product performance in terms of stain resistance and durability. It contains 29% recycled content.

### Tarasafe Standard: Sparclean® Treated

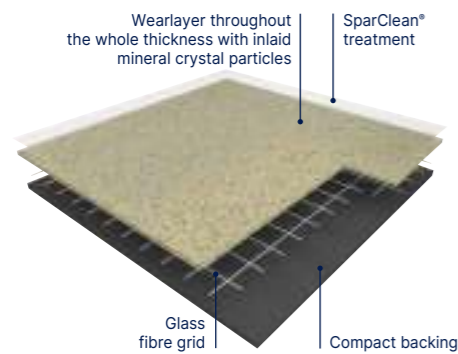

**TARASAFE STANDARD** is a hardwearing safety flooring collection that comprises of a PVC wear layer and deeply inlaid mineral crystal particles (patented). It is suitable for heavy traffic areas and is ideal for hardworking contract applications. It delivers Safety in Numbers, with a PTV >36+ slip resistance (Dry & Wet), a R10 wet slip resistance rating and >20 Rtm/Rz surface roughness in accordance with HSE guidelines. The revolutionary **SparClean®** surface treatment improves the product performance in terms of stain resistance and durability. It contains 29% recycled content.

### Tarasafe Plus / Tarasafe Super: Non-Treated

#### Tarasafe Super

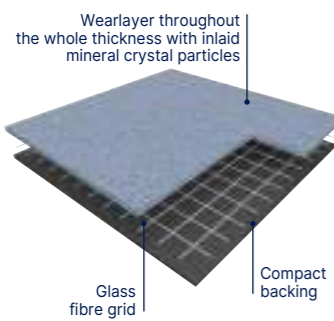

#### Tarasafe Plus

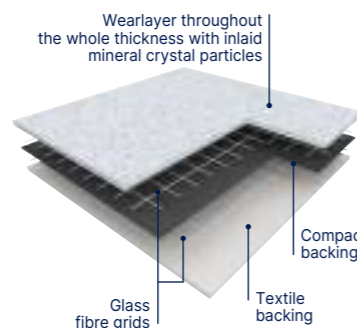

**TARASAFE PLUS** and **TARASAFE SUPER** are slip resistant safety vinyl floorcoverings, wearlayer throughout the whole thickness and deeply inlaid mineral crystal particles (patented). They are reinforced by a glass fibre grid and available in a sheet format. They are an ideal solution for heavy traffic applications where slip resistance, durability, hygiene and easy maintenance are required. **TARASAFE PLUS** comprises a textile backing for better adherence in wet areas. It helps reducing telegraphing. **TARASAFE SUPER** and **PLUS** are suitable for most contract & commercial areas. They are 100% recyclable, Floorscore® certified and do not contain any heavy metals or CMR 1&2, they are also 100% compliant with REACH. The product emission rate of volatile organic compounds is < 100 microgram/m<sup>3</sup> (TVOC after 28 days – ISO 16000 -6).

### Tarasafe Ultra H<sub>2</sub>O

See page 250

### Tarasafe H<sub>2</sub>O

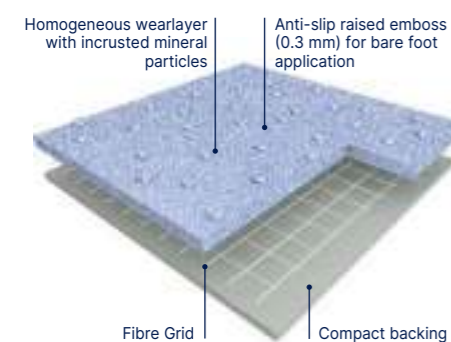

**TARASAFE H<sub>2</sub>O** is a hardwearing safety flooring collection that comprises of a PVC wear layer containing deeply inlaid mineral particles and coloured elements for a subtle and soft design. It is an ideal solution for those areas where enhanced slip resistance is required for both barefoot and shod use, such as showers, wet rooms, bathrooms, & changing areas. The specific embossing, together with the mineral particles, delivers a Class B barefoot slip resistance rating (according to EN 16165:2021-A and AS 4586-C) and R11 shod slip resistance rating (according to EN 16165: 2021-B and AS 4586-D). It delivers Safety in Numbers, with a PTV >50 slip resistance (Dry & Wet), a R11 wet slip resistance rating and >20 Rtm/Rz surface roughness in accordance with HSE guidelines. The revolutionary **SparClean®** surface treatment improves the product performance in terms of stain resistance and durability. It is reinforced with a glass fibre grid in sheet form for improved durability and is 100% recyclable. It contains 29% recycled content.



- **Easy to clean and maintain:** due to a compacted non porous surface made of vinyl content
- **Permanent slip resistance:** dense concentration of deep inlaid mineral crystal particles throughout the wear layer
- **Enhanced colour, design and brightness:** due to the mineral crystal particles
- **Highest abrasion rating**
- **Indoor Air Quality:** low VOC emission

Description	Tarasafe						
	Ultra	Standard	Super	Plus	H <sub>2</sub> O		
<b>Description</b>							
Total thickness	EN ISO 24346	mm	2.0	2.0	2.2	2.5	2.00
Thickness of wearlayer	EN ISO 24340	mm	0.85	0.85	1.12	1.14	0.85
Weight	EN ISO 23997	g/sqm	2360	2360	2880	3090	2350
Width/Length of sheet	EN ISO 24341	cm/ml	200/20	200/20	200/20	200/20	200/20
<b>Classification</b>							
Norm/Product specification	-	-	EN ISO 10582		EN ISO 10582		EN ISO 10582
European classification	EN ISO 10874	class	34-43	34-43	34-43		34-43
Fire rating	EN 13501-1	class	Bfl-s1	Bfl-s1	Bfl-s1		Bfl-s1
Static electrical propensity	EN 1815	kV	≤ 2	≤ 2	< 2		≤ 2
Slip resistance: Pendulum Test (dry & wet)	EN 16165:2021 – Appendix C (BS 7976-2)	PTV	> 36	> 36	-		> 50
Surface roughness Rz	-	µm	Rz ≥ 20	Rz ≥ 20	-		Rz ≥ 20
Slip resistance wet: Ramp test with oil	EN 16165:2021 – Appendix B (DIN 51130)	class	R10	R10	R12	R10	R11
Slip resistance wet: Ramp test with water	EN 16165:2021 – Appendix A (DIN 51097)	class	B	B	-		B
Slip resistance: Ramp test	EN 13845 (annex C)	class	ESf / ESb	ESf / ESb	-		ESf / ESb
Water tightness	EN 13553	-	-	-	-		OK
Slip resistance wet - areas	CTE	class	-	-	-		3
<b>Performances</b>							
Wear resistance	EN 660.2	mm <sup>3</sup>	≤2	≤2	≤2		-
Wear Group	-	group	T	T	-		-
Type Binder content	EN ISO 10582	type	I	I	I		I
Dimensional stability	EN ISO 23999	%	≤ 0.40	≤ 0.40	≤ 0.40		≤ 0.40
Residual indentation: exigency	EN ISO 24343-1	mm	≤ 0.10	≤ 0.10	≤ 0.10		≤ 0.10
Residual indentation (average measure)	-	mm	≤ 0.03	≤ 0.05	≈ 0.03		-
Castor chair test (type W)	ISO 4918	-	OK	OK	OK		OK
Thermal conductivity	EN ISO 10456	W/(m.K)	0.25	0.25	0.25		0.25
Colour fastness	EN ISO 105-B02	degree	≥ 6	≥ 6	≥ 6		≥ 6
Surface treatment	-	-	SparClean®	SparClean®	-		SparClean®
Chemical products resistance	EN ISO 26987	-	OK	OK	OK		OK
<b>Environment</b>							
Recyclability	-	%	100	100	100		100
EPD	-	-	Available	Available	Available		Available
<b>Health</b>							
TVOC after 28 days	ISO 16000-6	microgram/m <sup>3</sup>	< 100	< 100	< 100		< 100
Certification	-	-	Floorscore®	Floorscore®	Floorscore®		Floorscore®
Anti-bacterial activity (MRSA) <sup>(1)</sup>	ISO 22196	-	> 99% inhibits growth	> 99% inhibits growth	-		> 99% <sup>(2)</sup> inhibits growth
<b>CE marking</b>							
CE	EN 14041						

(1) The implementation of an effective cleaning regime is the most important defence against infection.

# Technical solutions

Tarasafe Ultra Sparclean®

Compact 2 m R10 SparClean®



8701 Opal

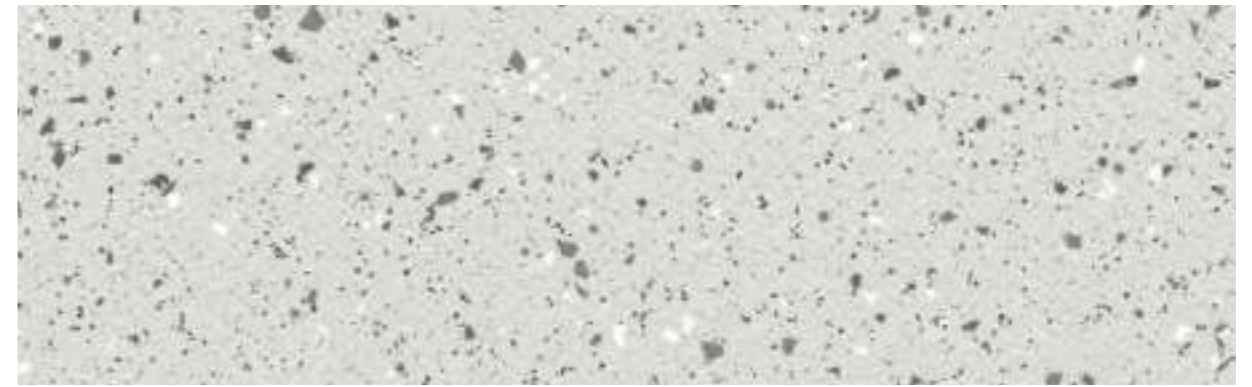

8701 Opal

^ Scale 1



Color reference available as Tarasafe Ultra H<sub>2</sub>O (R11).

# Technical solutions

## Tarasafe Standard - Plus - Super

Tarasafe Standard  
 Compact 2 m R10 SparClean®

Tarasafe Plus  
 Compact 2.5mm 2 m R10  
 Textile Backing

Tarasafe Super  
 Compact 2 m R12



7801 Noir  
 Compact

^ Scale 1



7731 Marbre<sup>(1)</sup>  
 Compact



7618 Edelweiss  
 Compact



7767 Dove Grey<sup>(1) (2)</sup>  
 Compact



7386 Savana<sup>(1) (2)</sup>  
 Compact



7773 Storm  
 Compact



7315 Jute  
 Compact



6589 Leaf  
 Compact



6084 Badian  
 Compact



6245 Atoll  
 Compact



8102 Paprika  
 Compact



2430 Rain Drop  
 Compact



6085 Grizzly  
 Compact



7709 Royal Blue  
 Compact

(1) Tarasafe Plus - (2) Tarasafe Super

## Tarasafe H2O



0036 Lagoa



0036 Lagoa  
 Compact

^ Scale 1



0034 Zambezi  
 Compact



0033 Rhine  
 Compact

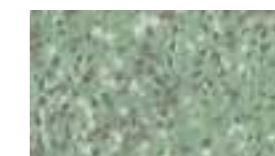

0035 Bacalar  
 Compact



0024 Peyto  
 Compact



0031 Eacham  
 Compact



0032 Malawi  
 Compact



0025 Nile  
 Compact

# Technical solutions

## Shower System

### Tarasafe Ultra H2O

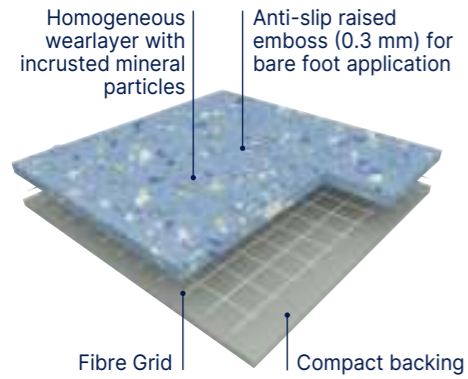

**TARASAFE ULTRA H2O** is a slip resistant vinyl floorcovering, wearlayer throughout the whole thickness and deeply inlaid mineral particles and coloured chips for a decorative design together with a raised emboss for better slip resistance. **TARASAFE ULTRA H2O** is an ideal solution for traffic applications where enhanced slip resistance with barefoot and durability are required such as wet areas. The specific embossing together with the mineral particles give a Class C barefoot slip resistance (DIN 51 097) and R11 slip resistance (DIN 51 130) which makes **TARASAFE ULTRA H2O** ideal for barefoot or shod applications. It is reinforced with a glass fibre grid in sheet form. Its homogeneous wear layer provides a group P of abrasion. According to ISO 22196, **TARASAFE ULTRA H2O** has **anti-bacterial activity** against MRSA of 99% after 24h. It does not contain any heavy metals or CMR 1&2 and it is 100% compliant with REACH. The product emission rate of volatile organic compounds is < 100 microgram/m<sup>3</sup> (TVOC after 28 days – ISO 16000 -6). This product is 100% recyclable and contains 39% recycled content.

### Tarasafe Design

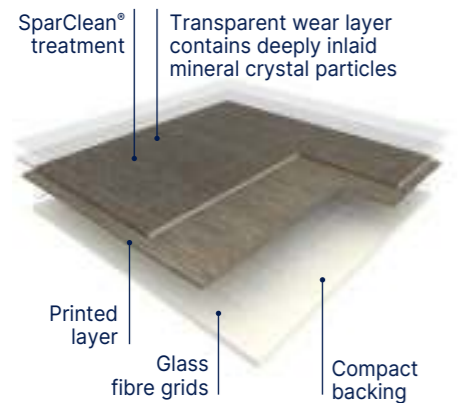

**TARASAFE COMPACT DESIGN** is a slip resistant vinyl floorcovering in sheet, which transparent wear layer contains deeply inlaid mineral crystal particles for durable shod (R10 according to DIN 51130) and barefoot (B according to DIN 51097) antislip performances. It is available in 6 realistic wood or mineral designs thanks to a printed layer. It is reinforced with a glass fibre grid and treated with SparClean® surface treatment, a low maintenance cost effective solution providing extreme resistance from soiling and staining. According to ISO 22196, it has an **anti-bacterial activity** against MRSA of 99% after 24 hours. It is an ideal solution for applications where enhanced slip resistance, durability, hygiene and easy maintenance are required – such as for instance showers, changing rooms, sanitation facilities, laboratories... It does not contain any heavy metals or CMR 1&2 and are 100% compliant with REACH. The product emission rate of volatile organic compounds is < 100 microgram/m<sup>3</sup> (TVOC after 28 days – ISO 16000-6). It is 100% recyclable.

### Mural Calypso

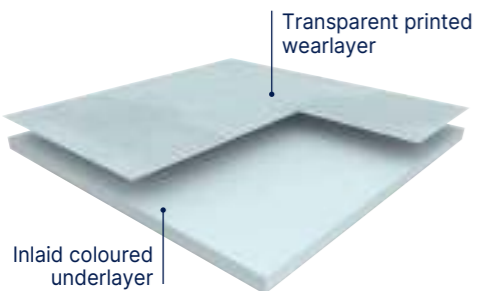

**MURAL CALYPSO** is a multilayered wall covering in 2 m width roll and with a **B-s2,d0 fire classification** according to EN 13501. It is hot welded with CR40 welding rods for a perfect water tightness. It is made of a printed transparent wear layer and a coloured under layer for a better aspect of the welding. This layer comprises up to 30% of recycled products. According to ISO 22196, **MURAL CALYPSO** has **anti-bacterial activity** against E. coli, S. aureus and MRSA of 99% after 24h. It does not contain any CMR 1 & 2 component and is 100% compliant with REACH. It is 100% recyclable. This wall covering is specially recommended for wet room areas and makes the installation in angles easier thanks to its flexibility. The Shower System is compliant with most laws on "access for all" thanks to the installation in shower without tray.

Gerflor also recommends the Tarasafe compact ranges with surface treatments (SparClean®: Ultra, Standard & Design) for the use in wet room areas. See pages 244-246 & 251

Floor & wall accessories for wet rooms (profiles, drains & threshold) on [gerflor.com](http://gerflor.com)

## Tarasafe Ultra H2O / Tarasafe Design / Mural Calypso



The SHOWER SYSTEM provides a safe and hygienic solution thanks to:

- Anti-slip resistance floorings
- 100% waterproof installation

			Tarasafe Ultra H <sub>2</sub> O	Tarasafe Design	Mural Calypso
<b>Description</b>					
Total thickness	EN ISO 24346	mm	2.0 (on grainside)	2.0	0.92
Thickness of wearlayer	EN ISO 24340	mm	1.0	0.80	0.10
Weight	EN ISO 23997	g/sqm	2400	2500	1610
Width/Length of sheet	EN ISO 24341	cm/ml	200/20	200/20	200/30
<b>Classification</b>					
Product specification	-	-	EN ISO 10582	EN ISO 10582	EN 259-1
European classification	EN ISO 10874	class	34-43	34-43	-
Fire rating	EN 13501-1	class	Cfl-s1	Bfl-s1	B-s2,d0
Static electrical propensity	EN 1815	kV	≤ 2	< 2	-
Slip resistance - Pendulum Test (dry & wet)	EN 16165:2021 – Appendix C (BS 7976-2)	PTV	> 36	> 36	-
Surface roughness	-	µm	Rz ≥ 20	-	-
Slip resistance wet - test with oil	EN 16165:2021 – Appendix B (DIN 51 130)	class	R11	R10	-
Slip resistance wet - bare foot	EN 16165:2021 – Appendix A (DIN 51097)	class	C	B	-
Slip resistance - ramp test	EN 13845 (annex C)	class	ESb	ESf / ESb	-
Water tightness	EN 13553	-	OK	OK	-
Slip resistance wet - areas	CTE	class	3	-	-
<b>Performances</b>					
Wear Resistance	EN 660.2	mm <sup>3</sup>	≤ 4	-	-
Wear Group	NF 189	group	P	-	-
Type Binder content	ISO 10582	type	I	I	-
Dimensional stability	EN ISO 23999	%	≤ 0.40	≤ 0.40	-
Residual indentation	EN ISO 24343-1	mm	≤ 0.10	≤ 0.10	-
Residual indentation (measure)	-	mm	≤ 0.03	≤ 0.03	-
Castor Chair test (type W)	ISO 4918	-	OK	-	-
Thermal conductivity	EN ISO 10456	W/(m.k)	0.25	0.25	-
Colour fastness	EN ISO 105-B02	degree	≥ 6	≥ 6	≥ 6
Surface treatment	-	-	-	SparClean®	-
Chemical products resistance	EN ISO 26987	-	OK	OK	OK
<b>Environment</b>					
Recyclability	-	%	100	100	100
EPD	-	-	Available	Available	Available
<b>Health</b>					
TVOC after 28 days	ISO 16000-6	microgram/m <sup>3</sup>	< 100	< 100	< 100
Certification	-	-	Floorscore®	Floorscore®	-
Anti-bacterial activity <sup>(1)</sup> (E. coli - S. aureus - MRSA)	ISO 22196	-	> 99% <sup>(2)</sup> inhibits growth	> 99% <sup>(2)</sup> inhibits growth	> 99% <sup>(3)</sup> inhibits growth
<b>CE marking</b>					
	EN 15102		-	-	OK
CE	EN 14041				

(1) The implementation of an effective cleaning regime is the most important defence against infection.

(2) Anti-bacterial activity (MRSA)

(3) Anti-bacterial activity (E. coli - S. aureus - MRSA)

# Technical solutions

## Antislip Floorings - Tarasafe Ultra H2O

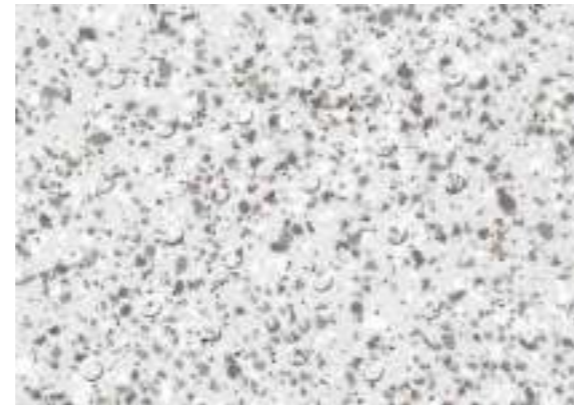

7720 Iceberg ^ Scale 1



7732 Gravel



7746 Stone



7325 Seashore



7413 Ocean Blue



## Antislip Floorings - Tarasafe Design



6171 Lofter Dark Grey

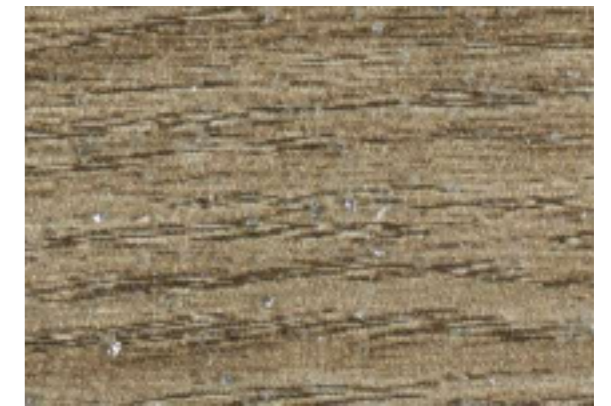

6079 Esterel Nut New ^ Scale 1



6078 Esterel Clear New



6083 Esterel Blossom New



5755 Lorca Natural New



6171 Lofter Dark Grey



6094 Infinity Sand



# Technical solutions

## Mural Calypso



Bs2d0



100% recyclable

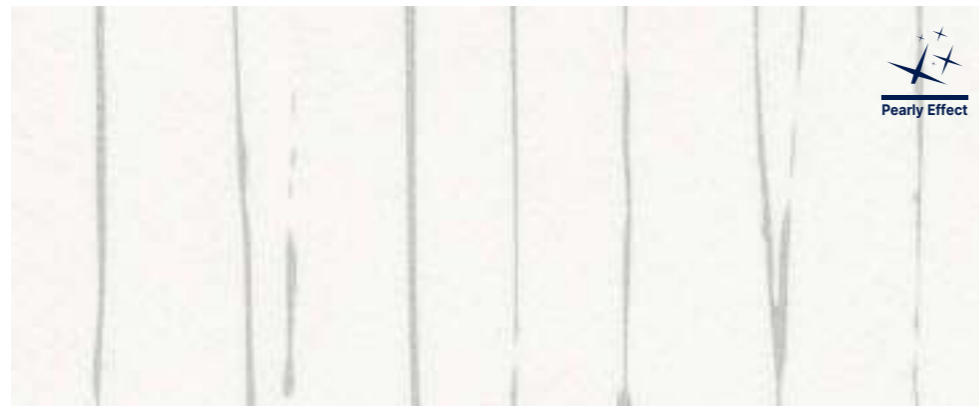

7000 Bamboo Snow Pearl\*  
Ⓢ

^ Décor échelle 1



Mural Calypso: Venice  
Tarasafe Standard: Dove Grey



7002 Bamboo Lotus\*\*  
Ⓢ

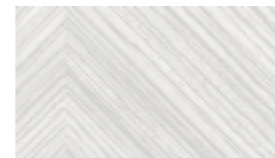

7026 Arty Grey  
Ⓢ



7025 Arty Beige  
Ⓢ



7744 Nordic Milk  
Ⓢ



7611 Uni Snow  
Ⓢ

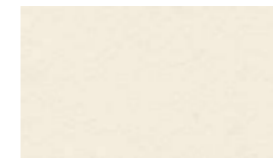

7021 Uni Lotus  
Ⓢ

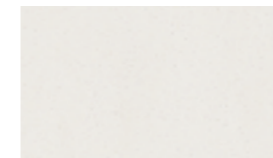

7020 Uni Ice  
Ⓢ

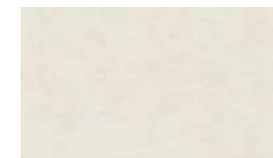

7711 Cloud Ice  
Ⓢ

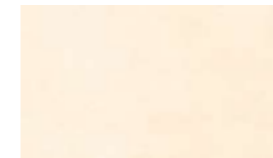

7309 Cloud Lotus  
Ⓢ



7017 Cloud Pink  
Ⓢ



7014 Ginko Snow Green\*  
Ⓢ



7013 Ginko Snow Gold\*  
Ⓢ



7022 Envol Snow Green\*  
Ⓢ



7023 Envol Snow Skyline\*  
Ⓢ



7016 Tropic Terra Copper  
Ⓢ



7015 Tropic Skyline  
Ⓢ



7018 Cloud Green  
Ⓢ

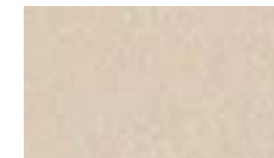

7311 Cloud Linen  
Ⓢ

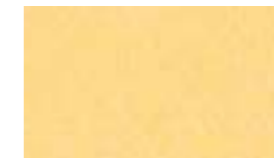

7201 Cloud Moonlight  
Ⓢ



7408 Cloud Skyline  
Ⓢ



7019 Cloud Terra  
Ⓢ



7024 Venice  
Ⓢ



7027 Verona  
Ⓢ



7740 Fabric Silk  
Ⓢ



7721 Manhattan Mist  
Ⓢ



7005 Blossom Snow Pearl\*  
Ⓢ

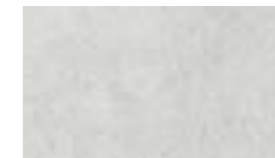

7010 Cloud Haze  
Ⓢ

\*Matching design: 7611 Uni Snow  
\*\*Matching design: 7021 Uni Lotus

More information on accessories (drains, threshold...) on [gerflor.com](http://gerflor.com).

Creative by Nature

## DLW Linoleum

pages 254-283

### 264. Compact / Acoustic Linoleum

- 266. Marmorette
- 272. Colorette
- 274. Uni Walton
- 276. Lino Art Urban **New**
- 278. Lino Art Moon **New**

### 280. Technic Linoleum

- 281. Linodur -  
High Mechanical Traffic Resistance
- 281. Marmorette LCH -  
Dissipative Linoleum for ESD areas

# DLW Linoleum

Creative by Nature



**98%**  
natural

**83%**  
Rapidly renewable

38% Linseed oil	26% Wood flour	14% Limestone
7% Jute	7% Resin	1% Coloured pigments
1% Cork	4% Coffee chaff	

To fight climate emergency and natural resources depletion, every choice counts. DLW Linoleum is a 98% natural, low carbon and circular flooring solution.

**we care / we act**

## Sustainable by Nature

### Cradle to Cradle Certified™ SILVER<sup>(1)</sup>

Developed using circular economy principles

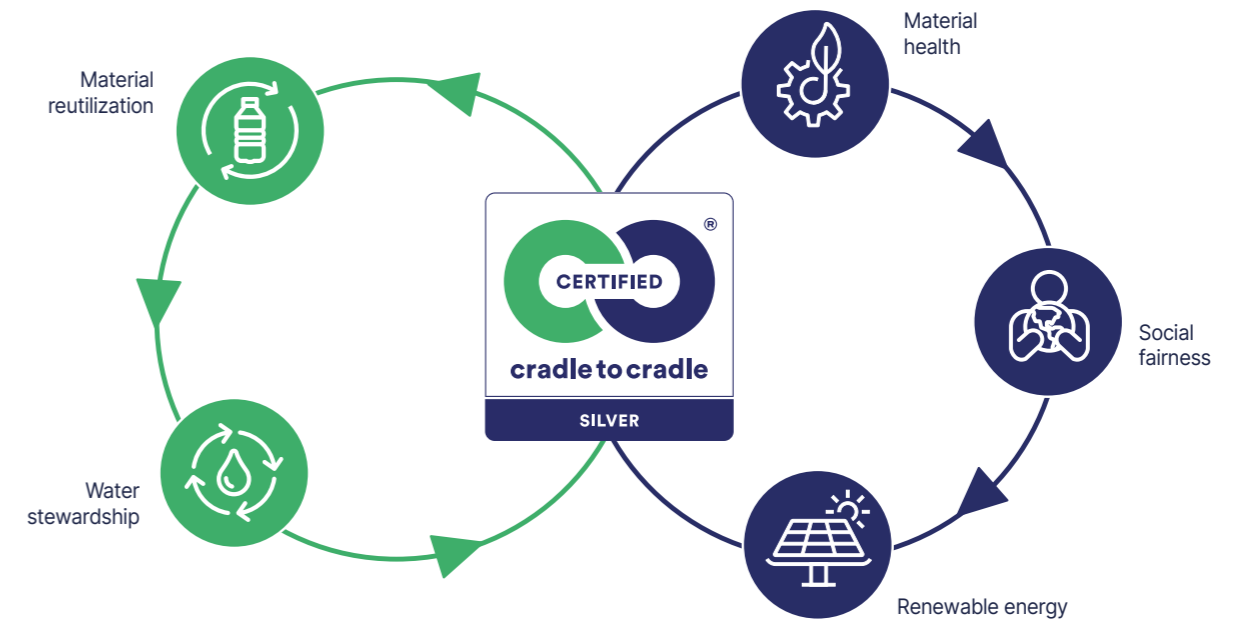

Cradle Certified™ is a registered trademark of the Cradle to Cradle Products Innovation Institute.

### Carbon neutral<sup>(2)</sup>



Third party certified EPD indicates carbon neutrality during the first stages of its life cycle.

Up to **40%**

Recycled content

### 100% recyclable



All Gerflor floorings are 100% recyclable and eligible to **Gerflor Second Life collection and recycling program**. Free collection of installation waste is available in 10 countries.

(1) Marmorette, Colorette, Uni Walton, Linodur, Marmorette Acoustic 15dB, Lino Art. / Cradle Certified™ is a registered trademark of the Cradle to Cradle Products Innovation Institute.  
 (2) Cradle to Gate: From Cradle to Gate: includes raw materials and manufacturing process (A1-A3 stages of EPD). Source: Environmental Product Declaration (EPD). Certified by Evea. More information on gerflor.com



# DLW Linoleum

Protective by Nature

Exclusive



**Solvent-free surface protection, developed exclusively for linoleum**

Extremely hard-wearing due to triple laser uv cross-linking technology



**Indoor Air Quality**



- Very low VOC emissions TVOC < 10 microgram/m<sup>3</sup> after 28 days (ISO 16516)
- Certified according to the most demanding standards



**Natural Design**



Matt Effect



Marmorette  
0056 Foggy Blue



**Easy To Clean**



Standard Linoleum

- Dirt and stain barrier
- Cost effective maintenance
- Easy cleaning with a mop or any modern cleaning equipment



Neocare™

Detailed cleaning protocol available on [www.gerfor.com](http://www.gerfor.com)



**Hygiene**

DLW Linoleum floorings contribute to lower the microbe load (bacteria, virus, ...) and to minimise the risk of a contamination chain.

- Excellent resistance against disinfection chemicals
- Anti-viral and anti-bacterial activity



**Durable**



Standard Linoleum

NEOCARE™



- No sealing and waxing needed
- Higher scratch resistance
- Easy to repair: in case of heavily damaged flooring, DLW linoleum can be easily repaired using the spray buffing method (red disk)

**Waxing**



Neocare™ is a high performing surface treatment protecting against dirt, stains and scratches and does not require any sealing & waxing throughout the life of the product. Waxing remains an option.



# DLW Linoleum

## Mix & Match

Uni Walton  
0100 Ocean Blue

Marmorette  
0148 Ink Blue

Lino Art Urban  
0586 Light Clay

Marmorette  
0023 Dusty Blue

Colorette  
0052 Oxid Grey

Marmorette  
0098 Desert Beige

Uni Walton  
0062 Mediterranean Orange





Lino Art Moon  
0233 Venus

Colorette  
0073 Sand Yellow

Marmorette  
0117 Mandarin Orange



**Visualize your project**  
Interior Designer

			Marmorette		Colorette / Uni Walton	Lino Art Urban / Moon	Marmorette Acoustic	Marmorette Acoustic Plus Colorette Acoustic Plus Uni Walton Acoustic Plus	Linodur	Marmorette LCH	
Description			R10	Bfl-s1							
Total thickness	EN ISO 24346	mm	2.0 / 2.5 / 3.2	2.5	2.5	2.5	2.5	4.0	4.0	4.0	2.5
Backing	-	-	Jute fabric		Jute fabric	Jute fabric	Cork and jute fabric backing	Foam backing	Jute fabric	Jute fabric	
Thickness of cork/foam backing	EN ISO 24340	-	-		-	-	2	1.5	-	-	
Weight	EN ISO 23997	g/sqm	2400 / 2900 / 3800	2900	2900	2900	3900	3500	4700	3000	
Width of sheet	EN ISO 24341	cm	200		200	200	200	200*	200	200	
Length of sheet	EN ISO 24341	m	20-31		20-31	20-31	20-31	20-31*	app. 28	20 - 31	
<b>Classification</b>											
Norm/Product specification	-	-	EN ISO 24011		EN ISO 24011	EN ISO 24011	EN 687	EN 686	EN ISO 24011	EN ISO 24011	
European classification	EN ISO 10874	class	23 / 34 / 43		23 / 34 / 43	23 / 34 / 43	23 / 33 / 41	23 / 33 / 41	23 / 34 / 43	23 / 34 / 43	
Classement UPEC	-	-	- / U4P3E1/2C2		-	-	-	-	-	-	
Fire rating**	EN 13501-1	class	Cfl-s1		Bfl-s1	Cfl-s1	Cfl-s1	Cfl-s1	Cfl-s1	Cfl-s1	
Slip resistance	EN 16165:2021 – Appendix B (DIN 51130)	class	R9	R10	R9	R9	R9	R9	R10	R9	
Impact sound insulation	EN ISO 717-2	dB	3 dB / 5 dB / 6 dB	5 dB	5 dB	5 dB	5 dB	15 dB	19 dB	8 dB	5 dB
<b>Performances</b>											
Residual indentation	EN ISO 24343-1	mm	≤ 0,15	≤ 0,15	≤ 0,15	≤ 0,15	≤ 0,15	≤ 0,40	≤ 0,30	≤ 0,20	≤ 0,15
Residual indentation mesurage value	EN ISO 24343-1	mm	≈ 0,08 / ≈ 0,09 / ≈ 0,10	≈ 0,09	≈ 0,09	≈ 0,09	≈ 0,09	≈ 0,20	≈ 0,16	≈ 0,15	≈ 0,09
Colour fastness	EN ISO 105-B02	rating	≥ 6		≥ 6	≥ 6	≥ 6	≥ 6	≥ 6	≥ 6	≥ 6
Vertical resistance	EN 1081	Ohm	-		-	-	-	-	-	-	10 <sup>6</sup> ≤ R ≤ 10 <sup>8</sup>
Point contact resistance	VDE 0100	kOhm	> 200		> 200	> 200	> 200	> 200	> 200	> 200	> 100
Static electrical propensity	EN 1815	kV	≤ 2		≤ 2	≤ 2	≤ 2	≤ 2	≤ 2	≤ 2	≤ 2
Castor chair test (Type W)	ISO 4918	-	OK		OK	OK	OK	OK	OK	OK	OK
Flexibility	ISO 24344	mm	Ø 40 (2.5 mm)		Ø 40	Ø 40	Ø 60	Ø 40	Ø 60	Ø 40	
Flexibility / average measured value	ISO 24344	mm	≈ Ø 30 (2.5 mm)		≈ Ø 30	≈ Ø 30	≈ Ø 30	Ø 35	≈ Ø 50	≈ Ø 30	
Thermal resistance	EN 12667	(m <sup>2</sup> /K)/W	0.012 / 0.015 / 0.018	0.015	0.015	0.015	0.04	0.044	0.023	0.015	
Thermal conductivity	EN ISO 10456	W/(m.K)	0.17		0.17	0.17	0.17	0.0937	0.17	0.17	
Surface treatment	-	-	Neocare™		Neocare™	Neocare™	Neocare™	Neocare™	Neocare™	Neocare™	
Chemical products resistance	EN ISO 26987	-	Excellent		Excellent	Excellent	Excellent	Excellent	Excellent	Excellent	
<b>Environment</b>											
Recycled content (average)	-	%	Up to 40	Up to 40	Up to 40	Up to 40	Up to 40	98	Up to 40	Up to 40	
Recyclability	-	%	100		100	100	100	100	100	100	
EPD	-	-	Available		Available	Available	Available	In progress	Available	Available	
<b>Health</b>											
TVOC after 28 days	EN 16516	microgram/m <sup>3</sup>	< 10		< 10	< 10	< 10	< 10	< 50	< 10	
Anti-bacterial activity (E. coli – S. aureus – MRSA) after 24 h***	EN ISO 22196 / JIS Z 2801	-	> 99.99 % inhibits growth		> 99.99 % inhibits growth	> 99.99 % inhibits growth	> 99.99 % inhibits growth	> 99.99 % inhibits growth	> 99.99 % inhibits growth	> 99.99 % inhibits growth	
Anti-viral activity (Human coronavirus) after 5 h***	ISO 21702	-	> 98.65 % virucidal activity		> 98.65 % virucidal activity	> 98.65 % virucidal activity	> 98.65 % virucidal activity	> 98.65 % virucidal activity	> 98.65 % virucidal activity	> 98.65 % virucidal activity	
<b>Circular economy</b>											
Certification	Cradle to Cradle	-	Silver	-	Silver	Silver	Silver	Bronze	Silver	-	
<b>CE marking</b>											
	EN 14041: 2004 AC: 2006	-					   				

\* Roll dimension 1.96m x 18-291m for single roll production.

\*\* Glued according to certificate. DOP numbers available from your local branch.

\*\*\* The implementation of an effective cleaning method is the best defence against infection.

 Depending on light exposure, the product color can vary, due to linoleum natural oxidization process. This process is reversible. We recommend that the samples be exposed to sunlight for several hours prior to making a final color choice.

# Compact Linoleum

Marmorette / Colorette / Uni Walton / Lino Art

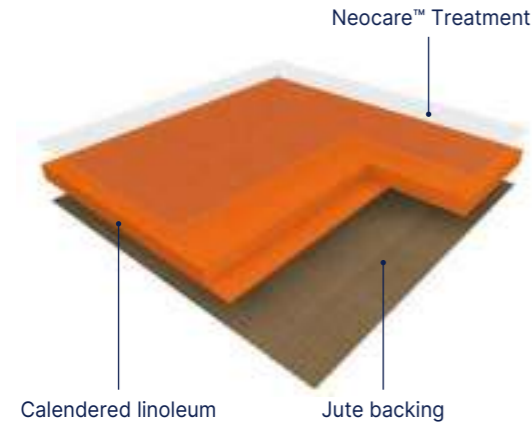

**MARMORETTE** is a calendered linoleum compact floorcovering in sheet, 2m wide, providing excellent resistance to everyday wear and tear in high traffic areas. Its weight is 2400g/sqm in 2.0mm, 2900g/sqm in 2.5mm and 3800g/sqm in 3.2mm. It features a marbled design and presents a matt finish, is composed of 98% natural materials (linseed oil, wood flour, resin, minerals, coffee chaff and jute fabric) among of which 83% are rapidly renewable.

**COLORETTE** is a calendered linoleum compact floorcovering in sheet, 2m wide, providing excellent resistance to everyday wear and tear in high traffic areas. Its weight is 2900g/sqm in 2.5mm. It features a speckled design and presents a matt finish, is composed of 98% natural materials (linseed oil, wood flour, resin, minerals, coffee chaff and jute fabric) among of which 83% are rapidly renewable.

**UNI WALTON** is a calendered linoleum compact floorcovering in sheet, 2m wide, providing excellent resistance to everyday wear and tear in high traffic areas. Its weight is 2900g/sqm in 2.5mm. It features a uni design and presents a matt finish, is composed of 98% natural materials (linseed oil, wood flour, resin, minerals, coffee chaff and jute fabric) among of which 83% are rapidly renewable.

**LINO ART** is a calendered linoleum compact floorcovering in sheet, 2m wide, providing excellent resistance to everyday wear and tear in high traffic areas. Its weight is 2900g/sqm in 2.5mm. It features a modern urban & terrazzo design (moon) and presents a matt finish, is composed of 98% natural materials (linseed oil, wood flour, resin, minerals, coffee chaff and jute fabric) among of which 83% are rapidly renewable.

## COLORETTE, MARMORETTE, UNI WALTON, LINO ART

The floorings are produced with Neocare™ solvent-free surface treatment, an exclusive photo-cured acrylate based lacquer surface treatment obtained by triple laser UV cross linking. Neocare™ offers excellent scratch resistance as well as resistance to chemicals found in aggressive environments such as bleach, hydro alcoholic solutions, Betadine and Eosin as well as markers making maintenance easier and increasing the life of the flooring. This treatment avoids performing any polishing throughout the lifetime of the product. It can however be polished following usual recommendations and according to the customer's wishes.

The products ensure perfect indoor air quality (TVOC at 28 days (EN 16516) < 10 microgram/m<sup>3</sup>) and are classified A + (the best class) in the context of health labeling. It is Floorscore®, M1 and Blue Angel certified.

The floorings are 100% recyclable, are composed of up to 40% recycled content, 100% controlled, are REACH compliant and rated Cfl-s1 for fire resistance.

Designed and manufactured in a sustainable way in a plant awarded with ISO 9001 (quality), ISO 14001 (environment) and ISO 50001 (energy) certifications, the floorings are Cradle to Cradle certified™ Silver. They are Environmental Performance Declaration (EPD) certified by an external laboratory indicating carbon neutrality during the first stages of their life cycle ("from cradle to gate"). The Camouflage (Marmorette) or Uni (Colorette, Uni Walton, Lino Art) welding rod makes the connections between the strips invisible.

They are antistatic, antibacterial according to ISO 22196 / JIS Z 2801 and antiviral according to ISO 21702.

# Acoustic Linoleum

Marmorette AcousticPlus /  
Colorette AcousticPlus /  
Uni Walton AcousticPlus

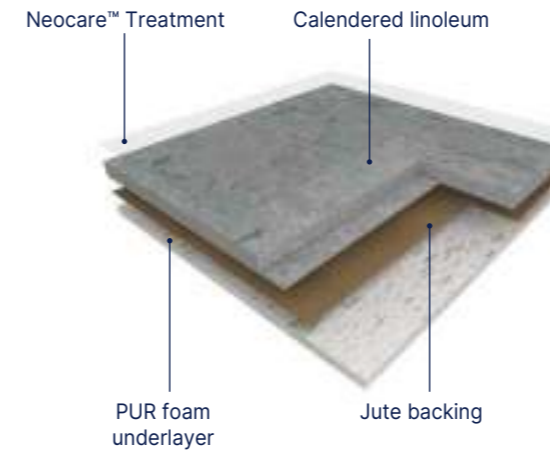

**MARMORETTE ACOUSTIC PLUS** is a calendered linoleum acoustic floorcovering in sheet, 2m wide, providing excellent resistance to everyday wear and tear in high traffic areas. Its weight is 3500g/sqm in 4.0mm. It features a marbled design and presents a matt finish, is composed of natural materials (linseed oil, wood flour, resins, minerals coffee chaff and jute fabric), rapidly renewable and features a 1.5mm recycled foam underlayer, ensuring up to 19dB impact sound reduction.

**COLORETTE ACOUSTIC PLUS** is a calendered linoleum acoustic floorcovering in sheet, 2m wide, providing excellent resistance to everyday wear and tear in high traffic areas. Its weight is 3500g/sqm in 4.0mm. It features a speckled design and presents a matt finish, is composed of natural materials (linseed oil, wood flour, resins, minerals coffee chaff and jute fabric), rapidly renewable and features a 1,5mm recycled foam underlayer, ensuring up to 19dB impact sound reduction.

**UNI WALTON ACOUSTIC PLUS** is a calendered linoleum acoustic floorcovering in sheet, 2m wide, providing excellent resistance to everyday wear and tear in high traffic areas. Its weight is 3500g/sqm in 4.0mm. It features a uni design and presents a matt finish, is composed of natural materials (linseed oil, wood flour, resins, minerals coffee chaff and jute fabric), rapidly renewable and features a 1,5mm recycled foam underlayer, ensuring up to 19dB impact sound reduction.

Marmorette Acoustic

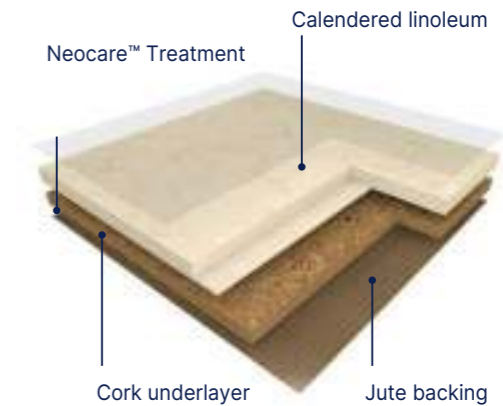

**MARMORETTE ACOUSTIC** is a calendered linoleum acoustic floorcovering in sheet, 2m wide, providing excellent resistance to everyday wear and tear in high traffic areas. Its weight is 3900g/sqm in 4.0mm. It features a marbled design and presents a matt finish, is composed of natural materials (linseed oil, wood flour, resins, cork, minerals coffee chaff and jute fabric), rapidly renewable and features a 2mm cork underlayer, ensuring up to 15dB impact sound reduction.

## MARMORETTE ACOUSTIC PLUS / COLORETTE ACOUSTIC PLUS / UNI WALTON ACOUSTIC PLUS / MARMORETTE ACOUSTIC

The floorings are produced with Neocare™ solvent-free surface treatment, an exclusive photo-cured acrylate based lacquer surface treatment obtained by triple laser UV cross linking. Neocare™ offers excellent scratch resistance as well as resistance to chemicals found in aggressive environments such as bleach, hydro alcoholic solutions, Betadine and Eosin as well as markers making maintenance easier and increasing the life of the flooring. This treatment avoids performing any polishing throughout the lifetime of the product. It can however be polished following usual recommendations and according to the customer's wishes.

The products ensure perfect indoor air quality (TVOC at 28 days (EN 16516) < 10 microgram/m<sup>3</sup>) and are classified A + (the best class) in the context of health labeling. They are Floorscore®, M1 and Blue Angel certified. The floorings are 100% recyclable, are composed of up to 44% recycled content (Acoustic Plus), 100% controlled, are REACH compliant and rated Cfl-s1 for fire resistance.

Designed and manufactured in a sustainable way in a plant awarded with ISO 9001 (quality), ISO 14001 (environment) and ISO 50001 (energy) certifications, the floorings are Cradle to Cradle certified™ Bronze (Marmorette Acoustic Plus, Colorette Acoustic Plus) and Cradle to Cradle certified™ Silver (Marmorette Acoustic). Their Environmental Performance Declaration (EPD) certified by an external laboratory, indicate carbon neutrality during the first stages of their life cycle ("from cradle to gate").

The Camouflage (Marmorette) or Uni (Colorette, Uni Walton, Lino Art) welding rod makes the connections between the strips invisible. They are antistatic, antibacterial according to ISO 22196 / JIS Z 2801 and antiviral according to ISO 21702.

## Korkment: Cork Acoustic Underlayer



2.0 mm underlayer  
(weight 1.2 kg/sqm)  
15 dB impact sound  
reduction

Ref R1020102

# Compact / Acoustic Linoleum

## Marmorette



Neocare™



0155 Smoked Pearl  
2,5 mm



0056 Foggy Blue  
2,5 mm / 3,2 mm



0153 Greystone Grey  
2,5 mm



0158 Tabac Grey  
2,5 mm



0055 Ash Grey  
2,0 mm / 2,5 mm / 3,2 mm



0053 Ice Grey  
2,0 mm / 2,5 mm / 3,2 mm



0050 Quartz Grey  
2,0 mm / 2,5 mm / 3,2 mm



0059 Plumb Grey  
2,0 mm / 2,5 mm / 3,2 mm



0054 Concrete Patty  
2,5 mm



0160 Industrial Grey  
2,0 mm / 2,5 mm

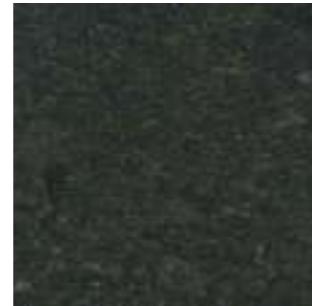

0096 Midnight Grey  
2,5 mm



0108 Mokka Brown  
2,5 mm



0254 Mineral Grey  
2,5 mm

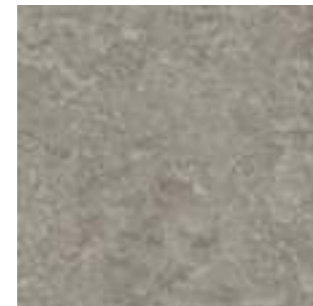

0166 Clay  
2,5 mm



0164 Milk Coffee  
2,5 mm



0252 Light Grey  
2,5 mm

^ Scale 1



0251 Cream  
2,5 mm



0146 Beeswax Beige  
2,5 mm



0059 Plumb Grey



0253 Pebble Grey  
2,5 mm



0090 Soapstone  
2,5 mm



0106 Hazelnut Shake  
2,5 mm



0003 Dark Brown  
2,5 mm



0091 Shiitake Mushroom  
2,5 mm



0089 Peacan Pie  
2,5 mm

**A** Acoustic 15 dB in stock   **A+** AcousticPlus 19 dB in stock   **R10** R10: in stock   **Bfl** Bfl-s1: in stock

All other colours can be manufactured in Acoustic 15dB version. Special request - Minimum order quantity: 1500sqm. Below 1500sqm, use Korkment underlayer.  
All other colours can be manufactured in Acoustic Plus 19dB version. Special request - Minimum order quantity: 58sqm.

# Compact / Acoustic Linoleum

## Marmorette



Neocare™

2.0mm

2.5mm

3.2mm



0072 Golden Yellow  
2,5 mm



0172 Papaya Orange  
2,5 mm



0076 Pale Yellow  
2,5 mm



0098 Desert Beige  
2,0 mm / 2,5 mm

A



0070 Rocky Brown  
2,0 mm / 2,5 mm / 3,2 mm

A+ R10 Bfl

^ Scale 1



0042 Shortcrust  
2,5 mm



0073 Spicy Orange  
2,5 mm



0173 Melon Orange  
2,5 mm

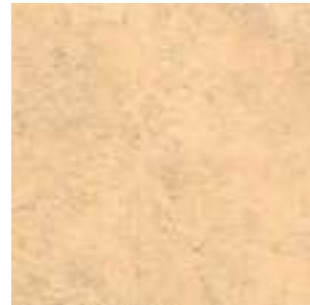

0243 Marble Beige  
2,5 mm



0045 Sand Beige  
2,0 mm / 2,5 mm

A A+ R10 Bfl



0040 Light Sahara  
2,0 mm / 2,5 mm

A+



0117 Mandarin Orange  
2,5 mm



0118 Chili Red  
2,5 mm



0018 Lobster Red  
2,5 mm



0145 Banana White  
2,5 mm



0119 Terracotta  
2,5 mm

A+



0019 Sunset Orange  
2,5 mm

A



0075 Light Aurora  
2,5 mm



0211 Pink  
2,5 mm



0092 Beach  
2,5 mm

A Acoustic 15 dB in stock    A+ AcousticPlus 19 dB in stock    R10 R10: in stock    Bfl Bfl-s1: in stock

All other colours can be manufactured in Acoustic 15dB version. Special request - Minimum order quantity: 1500sqm. Below 1500sqm, use Korkment underlayer.  
All other colours can be manufactured in Acoustic Plus 19dB version. Special request - Minimum order quantity: 58sqm.

# Compact / Acoustic Linoleum

## Marmorette



Neocare™



0129 Curacao Petrol  
2,5 mm



^ Scale 1  
0099 Grey Turquoise  
2,5 mm

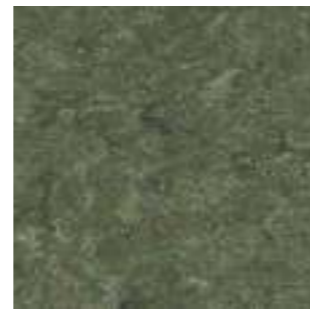

0083 Jungle  
2,5 mm



0132 Lime Green

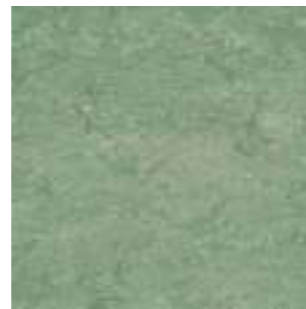

0043 Leaf Green  
2,5 mm



0138 Khaki  
2,5 mm



0130 Antique Green  
2,5 mm



0100 Frog Green  
2,5 mm



0132 Lime Green  
2,5 mm

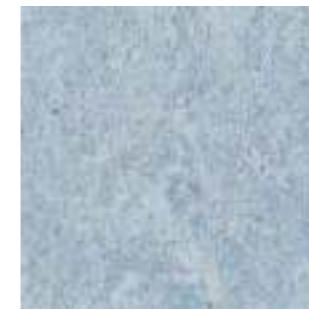

0121 Blue Eyes  
2,5 mm



0122 Fluffy Blue  
2,5 mm



0026 Sky Blue  
2,5 mm



0023 Dusty Blue A A+ R10 Bfl  
2,0 mm / 2,5 mm /  
3,2 mm

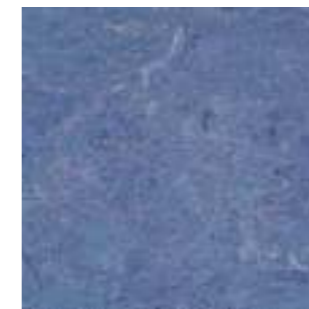

0049 Royal Blue  
2,5 mm / 3,2 mm



0022 Autumn Blue A+  
2,5 mm / 3,2 mm



0224 Mystery Blue  
2,5 mm

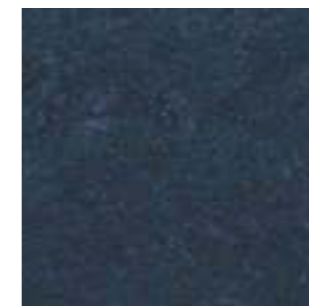

0149 Dark Blue  
2,5 mm



A+ 0148 Ink Blue  
2,5 mm



0128 Violet  
2,5 mm



0028 Dive  
2,5 mm



0136 Turquoise Bay  
2,5 mm

A Acoustic 15 dB in stock A+ AcousticPlus 19 dB in stock R10 R10: in stock Bfl Bfl-s1: in stock

All other colours can be manufactured in Acoustic 15dB version. Special request - Minimum order quantity: 1500sqm. Below 1500sqm, use Korkment underlayer.  
All other colours can be manufactured in Acoustic Plus 19dB version. Special request - Minimum order quantity: 58sqm.

# Compact / Acoustic Linoleum

## Colorette



0001 Banana Yellow  
2,5 mm

^ Scale 1



0071 Straw Beige  
2,5 mm

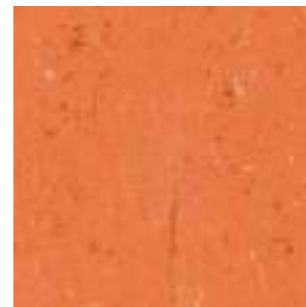

0016 Deep Orange  
2,5 mm

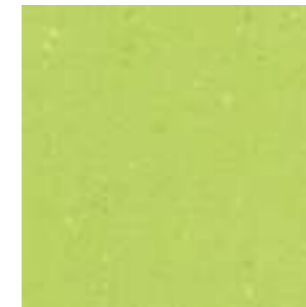

0132 Spicy Green  
2,5 mm



0052 Oxid Grey  
2,5 mm

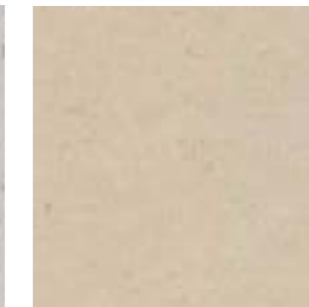

0012 Light Beige  
2,5 mm



© Jose Hevia



0073 Sand Yellow  
2,5 mm



0170 Kumquat Orange  
2,5 mm



0171 Sunrise Orange  
2,5 mm



0118 Power Red  
2,5 mm



0110 Cadillac Pink  
2,5 mm

AcousticPlus 19dB in stock



0006 Vivid Green  
2,5 mm

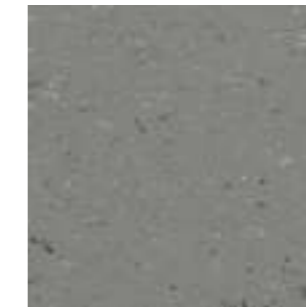

0059 Stone Grey  
2,5 mm



0043 Light Mud  
2,5 mm

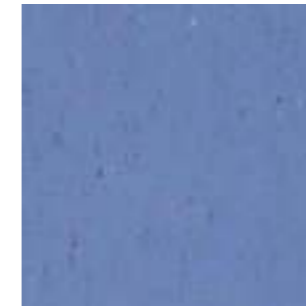

0004 Bluebird  
2,5 mm

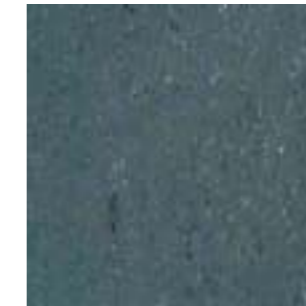

0080 Elephant Grey  
2,5 mm

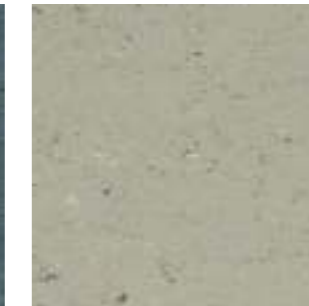

0058 Aluminium Grey  
2,5 mm



0123 Poppy Blue  
2,5 mm

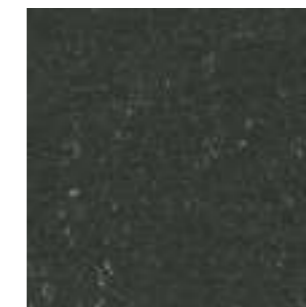

0081 Private Black  
2,5 mm

# Compact / Acoustic Linoleum

## Uni Walton



0100 Ocean Blue  
2,5 mm

^ Scale 1



0059 Frost Grey

© Celia Unalide Photog

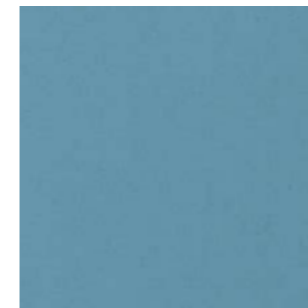

0095 Spring Blue  
2,5 mm



0062 Mediterranean Orange  
2,5 mm

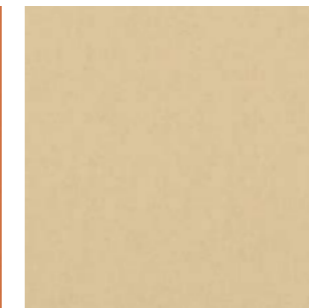

0043 Neutral Beige  
2,5 mm



0059 Frost Grey  
2,5 mm



0082 Broken Grey  
2,5 mm

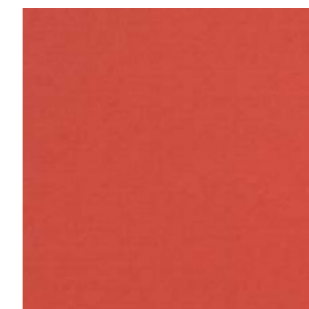

0010 Pompeji Red  
2,5 mm

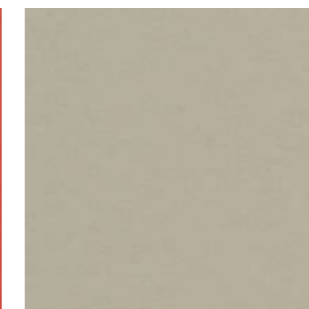

0085 Warm Concrete Grey  
2,5 mm



**A+** 0081 Nickel Grey  
2,5 mm

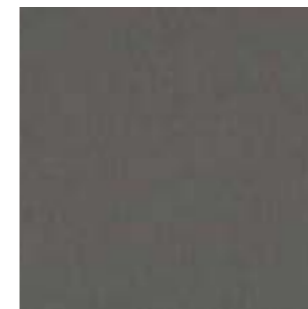

0083 Architects Grey  
2,5 mm

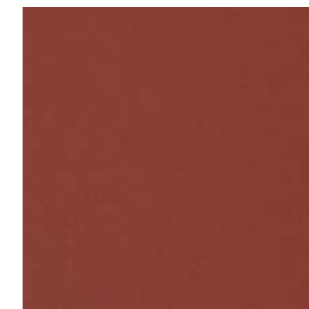

0088 Chestnut  
2,5 mm



0090 Olive  
2,5 mm

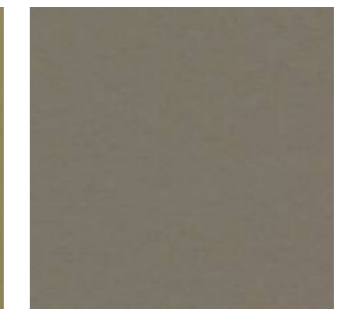

0058 Clay Grey  
2,5 mm

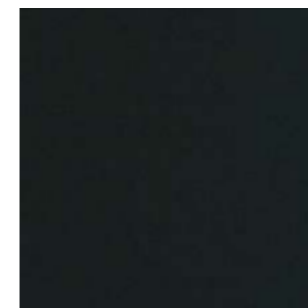

0080 Black  
2,5 mm

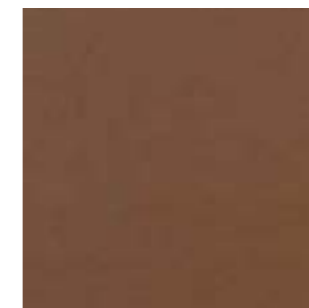

0060 Deep Brown  
2,5 mm

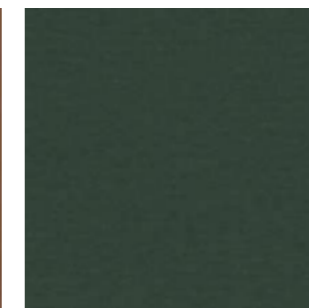

0035 Racing Green  
2,5 mm

**A+** AcousticPlus 19dB in stock

All other colours can be manufactured in Acoustic 15dB version. Special request - Minimum order quantity: 1500sqm. Below 1500sqm, use Korkment underlayer.  
All other colours can be manufactured in Acoustic Plus 19dB version. Special request - Minimum order quantity: 58sqm

# Compact / Acoustic Linoleum

Lino Art - Urban **New**

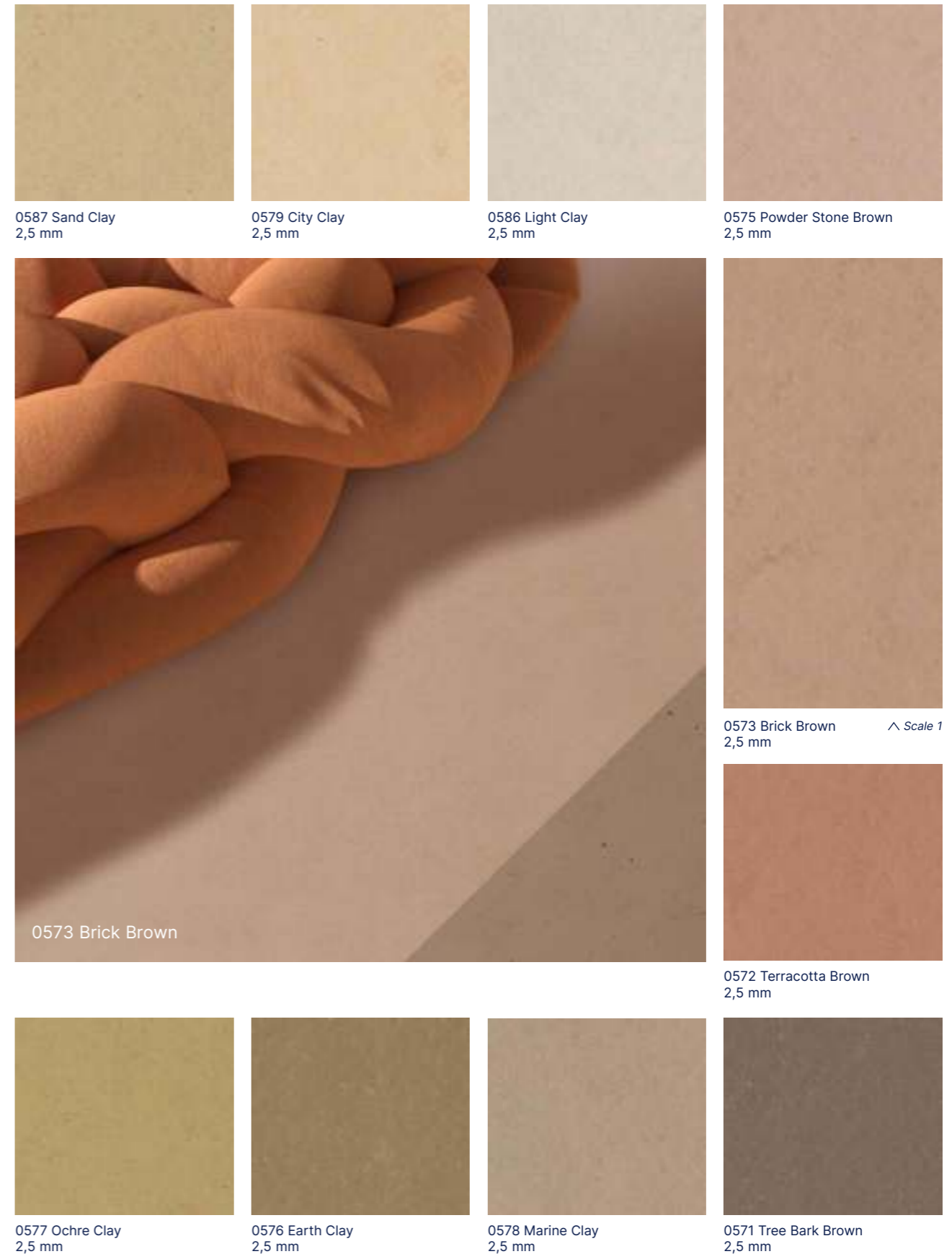

276 All colours can be manufactured in Acoustic 15dB version. Special request - Minimum order quantity: 1500 qm. Below 1500sqm, use Korkment underlayer.  
All colours can be manufactured in Acoustic Plus 19dB version. Special request - Minimum order quantity: 58sqm

# Compact / Acoustic Linoleum

Lino Art - Moon **New**



0235 Soil  
2,5 mm



0233 Venus  
2,5 mm



0232 Mercury  
2,5 mm



0231 Earth  
2,5 mm



0234 Sand  
2,5 mm



0236 Sun  
2,5 mm



0243 Space



0242 Stone  
2,5 mm

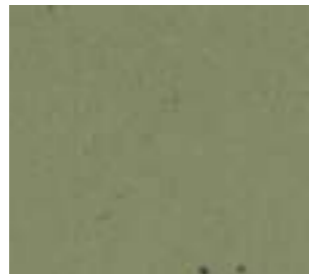

0241 Green Flash  
2,5 mm



0240 Rock  
2,5 mm



0238 Meteorite  
2,5 mm



0237 Volcanic  
2,5 mm

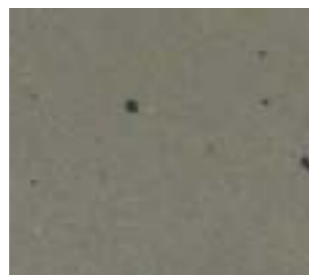

0239 Shadow  
2,5 mm



0243 Space  
2,5 mm

^ Scale 1



0235 Soil

**278** All colours can be manufactured in Acoustic 15dB version. Special request - Minimum order quantity: 1500 qm. Below 1500sqm, use Korkment underlayer.  
All colours can be manufactured in Acoustic Plus 19dB version. Special request - Minimum order quantity: 58sqm

# Technic Linoleum

## Linodur - High Mechanical Traffic Resistance

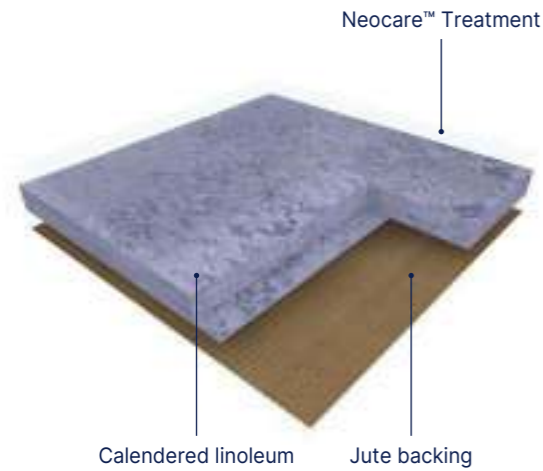

**LINODUR** is a calendered linoleum compact floorcovering in sheet, 2m wide, providing excellent resistance to everyday wear and tear in high pedestrian and mechanical traffic areas. Its weight is 4700g/sqm in 4.0mm. It features a discreet grain design and is composed of 98% natural materials (linseed oil, wood flour, resins, minerals coffee chaff and jute fabric) among of which 83% are rapidly renewable. The flooring is produced with Neocare™ solvent-free surface treatment, an exclusive photo-cured acrylate based lacquer surface treatment obtained by triple laser UV cross linking. Neocare™ offers excellent scratch resistance as well as resistance to chemicals found in aggressive environments such as bleach, hydro alcoholic solutions, Betadine and Eosin as well as markers making maintenance easier and increasing the life of the flooring. This treatment avoids performing any polishing throughout the lifetime of the product. It can however be polished following usual recommendations and according to the customer's wishes. The Camouflage welding rod makes the connections between the strips invisible. It is antistatic, antibacterial according to ISO 22196 / JIS Z 2801. The flooring is 100% recyclable, is composed of up to 32% recycled content, 100% controlled, is REACH compliant and rated Cfl-s1 for fire resistance. It is designed and manufactured in a sustainable way in a plant awarded with ISO 9001 (quality), ISO 14001 (environment) and ISO 50001 (energy) certifications. The Camouflage welding rod makes the connections between the strips invisible. It is antistatic, antibacterial according to ISO 22196 / JIS Z 2801.

## Marmorette LCH - Dissipative Linoleum For ESD Areas

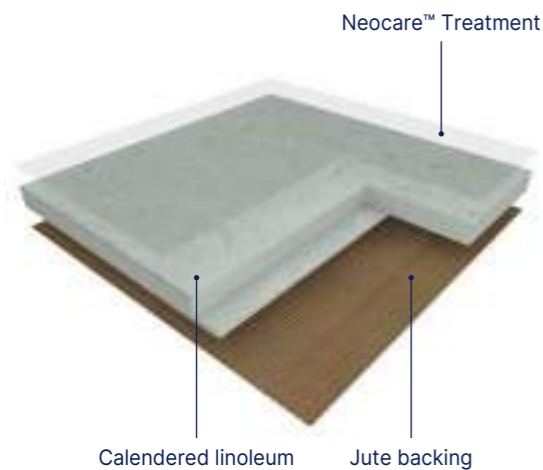

**MARMORETTE LCH** is a calendered linoleum compact dissipative floorcovering in sheet, 2m wide, providing excellent resistance to everyday wear and tear in high traffic areas. Its vertical resistance is  $106 < R < 108 \Omega$ . Its weight is 3000g/sqm in 2.5mm. It features a marbled design and presents a matt finish, is composed of 98% natural materials (linseed oil, wood flour, resins, minerals coffee chaff and jute fabric) among of which 76% are rapidly renewable. The flooring is produced with Neocare™ solvent-free surface treatment, an exclusive photo-cured acrylate based lacquer surface treatment obtained by triple laser UV cross linking. Neocare™ offers excellent scratch resistance as well as resistance to chemicals found in aggressive environments such as bleach, hydro alcoholic solutions, Betadine and Eosin as well as markers making maintenance easier and increasing the life of the flooring. This treatment avoids performing any polishing throughout the lifetime of the product. It can however be polished following usual recommendations and according to the customer's wishes. The flooring is 100% recyclable, is composed of up to 40% recycled content, 100% controlled, is REACH compliant and rated Cfl-s1 for fire resistance. It is designed and manufactured in a sustainable way in a plant awarded with ISO 9001 (quality), ISO 14001 (environment) and ISO 50001 (energy) certifications. The Camouflage welding rod makes the connections between the strips invisible. It is antistatic, antibacterial according to ISO 22196 / JIS Z 2801.

## Linodur - High Mechanical Traffic Resistance



1020 Spring Blue  
4.0 mm

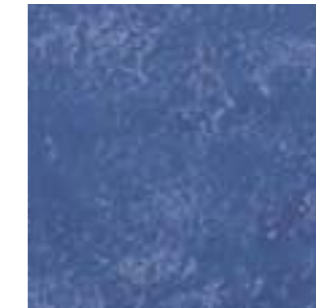

1024 Speckled Blue  
4.0 mm



1056 Marble Grey  
4.0 mm



0020 Spring Blue



1081 Sporty Black  
4.0 mm



1011 Avocado Green  
4.0 mm



1072 Peach Orange  
4.0 mm

## Marmorette LCH - Dissipative Linoleum for ESD areas



0023 Dusty Blue  
2.5 mm



0055 Ash Grey  
2.5 mm

# Finishes

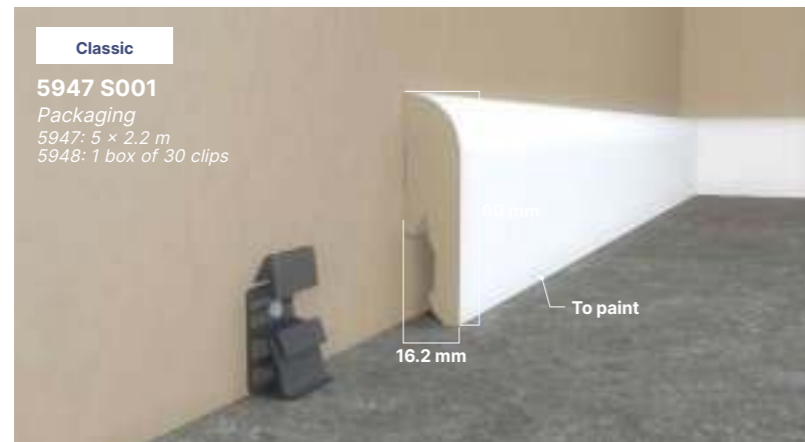

## Skirtings mdf

Color: White



## Skirtings cove former

Color: 6512



## Skirtings HSLA

## Welding rods

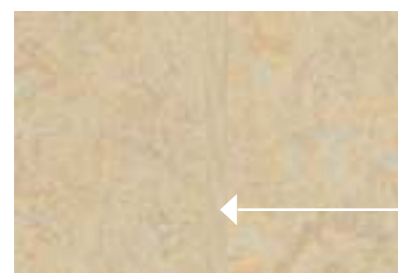

**Marmorette & Linodur**

Camouflage welding rod: invisible joints



**Colorette, Uni Walton & Lino Art**

Uni welding rod: a large palett of colours

Welding rod matching table available on: [gerflor.com](http://gerflor.com)

# Cleaning Neocare™-Treated Linoleum Floors

Marmorette / Colorette / Uni Walton / Lino Art



**Damp sweeping equipment**  
Flexible mop preferably fitted with single-use antistatic and/or pre-impregnated mop pads



**Manual cleaning equipment**  
Flat mop and washable microfinber pad



**Mechanical cleaning equipment**  
Auto scrubber, rotary cleaner or single-brush machine



**Steam cleaning equipment**  
Follow the manufacturer's recommendations



**Mechanical cleaning disk**  
3M colour discs or equivalent / melamine discs



**3M red rectangular pad or equivalent, or melamine rectangular pad**  
Can be used with or without pad holder and telescopic handle

	Equipment used	Cleaning products	Cleaning methods
<b>First use</b>	+  +  Melamine disc if very soiled	Water without detergent	<ul style="list-style-type: none"> <li>Damp sweeping</li> <li>Mechanical cleaning with melamine disc at 150-300 rpm (with water recovery)</li> </ul>
<b>Mechanical cleaning</b>	+  +  OR  or  if soil	Neutral detergent or Alkaline detergent	<ul style="list-style-type: none"> <li>Damp sweeping</li> <li>Mechanical cleaning at 150-300 rpm (with water recovery)</li> </ul>
<b>Regular cleaning</b>	+	Water or, if necessary Neutral detergent / Disinfectant detergent / Cleaning care product	<ul style="list-style-type: none"> <li>Damp sweeping</li> <li>Manual cleaning with flat mop and microfiber</li> </ul>
<b>Manual cleaning</b>	+  +  OR  or  light green	Water or, if necessary Neutral detergent / Cleaning care product	<ul style="list-style-type: none"> <li>Damp sweeping</li> <li>Mechanical cleaning at 150-300 rpm (with water recovery)</li> </ul>
<b>Mechanical cleaning</b>			<ul style="list-style-type: none"> <li>Follow the supplier instructions</li> </ul>
<b>Deep cleaning</b>		Water or neutral detergent	<ul style="list-style-type: none"> <li>Damp sweeping</li> <li>Manual cleaning with rectangular melamine pad</li> <li>Rinsing with clean water</li> </ul>
<b>Manual cleaning</b>		Alkaline detergent	<ul style="list-style-type: none"> <li>Damp sweeping</li> <li>Manual cleaning with red rectangular pad</li> <li>Rinsing with clean water</li> </ul>
<b>Mechanical cleaning</b>	+  +  OR  or  light green	Alkaline detergent	<ul style="list-style-type: none"> <li>Damp sweeping</li> <li>Mechanical cleaning at 150-300 rpm (with water recovery)</li> <li>Rinsing with clean water</li> </ul>
<b>Mechanical cleaning</b>	+  +  Melamine disc	Water or neutral detergent	<ul style="list-style-type: none"> <li>Damp sweeping</li> <li>Mechanical cleaning with melamine disc at 150-300 rpm (with water recovery)</li> </ul>

These cleaning instructions have to be adapted depending on traffic and location of the area.

Gerflor DLW flooring products are to be installed in full accordance with Gerflor DLW installation instructions and recognized trade standards.

An effective, regular cleaning and maintenance program is vital for retaining a high appearance level. Gerflor DLW flooring products should only be used as floorcoverings.

Note: Gerflor DLW reserve the right to amend this specification without giving prior notice. For the latest versions of the technical specifications, check our website: [www.gerflor.com](http://www.gerflor.com)

**INSTALLATION & MAINTENANCE GUIDELINES AVAILABLE ON GERFLOR.COM**





## Sports Floorings

pages 284-329

- 290. **Taraflex®**  
Synthetic Sports Floorings
- 312. **Connor Sports® Aspire I New**  
Engineered wood Flooring System
- 316. **Sport Court®**  
Outdoor Surfaces
- 322. **DLW**  
Linoleum Sports Floorings
- 326. **Powershock**  
Fitness Rubber Solutions
- 329. **Our solutions for yor fitness center**

# Gerflor, where champions play



## Indoor synthetic floors: the best performing products on the market

Taraflex® has been one of the pioneer in 1947 when developing synthetic floors and is today the world leading brand for indoor sports floor.

With a complete range of products, Gerflor offers the perfect solution adapted to all users and usages, from low impact activities through to elite and performance sports. Gerflor sets itself the highest standards when it comes to the environmental quality of its products.

Made in France 

## Taraflex® sport floors are recognised all over the world

Every day more than **8 millions children** play on a Taraflex® sports floor.

Per year, **3 500**

high level competitions are played on a Taraflex® sports floor.



Engineered wood flooring systems: more than 100 years of experience



Founded in 1872, Connor Sports® is the market leader in portable and permanent hardwood sports flooring systems. Connor Sports® professional engineers lead the industry in new product design and development, setting the standard for innovative solutions in sports surfacing. In 1914, Connor Sports® installed the first basketball court in the USA. In the late 90's, Boston Celtics selected Connor Sports® to repurpose their famed parquet into a portable flooring system.

*Please check availability in your zone with your local representative.*



Outdoor surfaces: world's leading outdoor sport surface



In 1974, Sport Court® created the outdoor game court. Since then, over 150,000 courts have been installed worldwide. Sport Court®'s superior outdoor play surface is designed to:

- keep athletes safe
- allow for year-round sports activity
- eliminate costly annual maintenance



Indoor sport areas: historic leader in linoleum sport flooring



DLW Linoleum has been manufacturing high class sport linoleum for over 30 years and is proud to deliver uncompromising product quality. Adapted to both specific and multi-function use, linoleum high performance floors are a great option to address various applications, from kindergartens to multipurpose halls and fitness centres. Thanks to its acknowledged sustainable features, millions of square metres of sport linoleum have been installed over the years and still convince new generations of users.

# Partner of major events

## Official and exclusive floor supplier

Taraflex® has become the trusted historical partner to a host of well-known major international sporting federations, delivering exclusive partnerships which demonstrates Gerflor's position as a worldwide leader in sports flooring.



# Gerflor, supplier of major international sports events



Sport is a catalyst for values such as solidarity and unity. At Gerflor, we embody these principles by designing Taraflex® sports flooring to promote an inclusive experience. We are proud to promote inclusion by designing products for Paralympic sports such as sitting volleyball and boccia. It enables everyone to actively participate and feel valued in the world of sport.

*"Gerflor Taraflex® is an amazing floor. Our athletes look forward to playing on this surface. They tell me they can move well because it slides well. They also appreciate the padding on the floor. It takes a lot of pressure off their shoulders, arms, and hands when they move. It is a fantastic floor for sitting volleyball!"*

**Bill Hamiter**, Women's Head Coach/Program Director, Sitting Volleyball USA National Team.



# Taraflex® Sport Floors

## Why should you choose Taraflex®?

### Sports floors are classified into 3 categories:

- Point-elastic floors such as Taraflex® sports floors
- Area-elastic floors such as sprung wooden floors
- Combined floors, providing a combination of point-elastic and area-elastic floor features

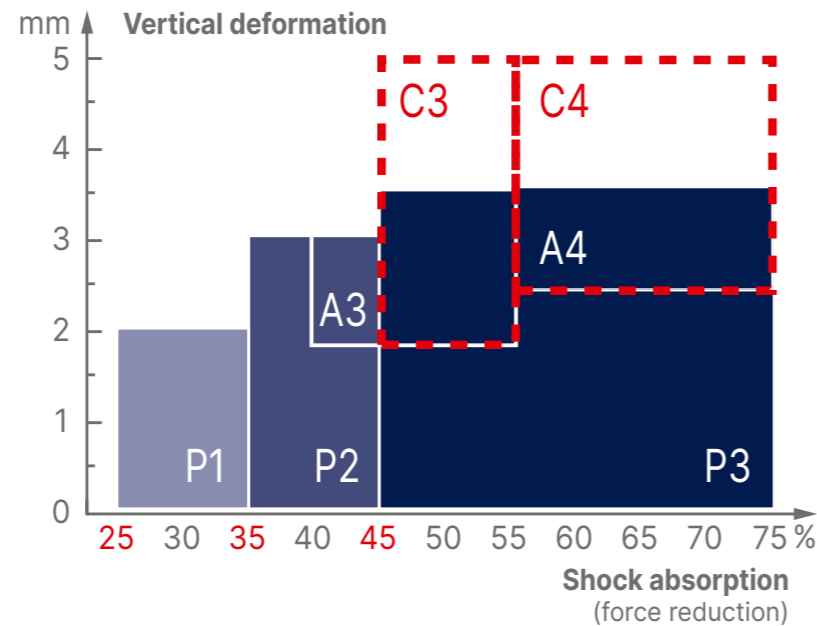

The objective of the European sport standards EN 14904 is to draw attention to the necessity of installing safe, comfortable floors. The purpose of a sports floor is to minimise the force of impact on the body and reduce the risk of long-term injury. This property is called safety and is measured by shock absorption.

EN 14904 determines shock absorption classes for all floors. A floor needs to provide minimum 25% shock absorption to be considered a sports floor.

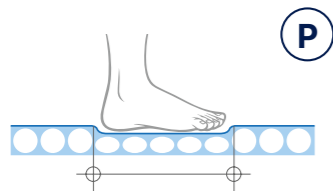

**Adapted to the greatest number of players** (children, teenagers, adults) and sports activities

#### Point-elastic floors

Point-elastic floors compress around the impact point to absorb the force of the impact. Point-elastic material deformation is a comfort indicator and makes this kind of floor particularly adapted to children. These properties make it more comfortable to walk and run, for every players.

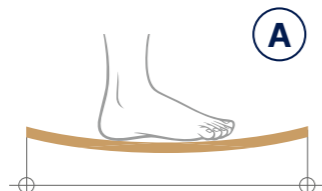

**Adapted to rolling sports and high-level basketball practice**

#### Area-elastic floors

Engineered to disperse impact energy across a wider surface area, these area-elastic floors offer athletes superior energy restitution, ensuring peak performance with every move. Plus, their unmatched ball bounce makes them the ultimate choice for top-tier sports facilities.

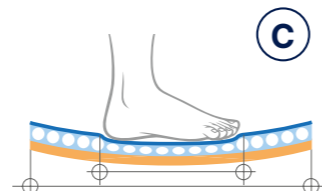

**Adapted to intense to high-level practice**

#### Combined floors

Combined floors are the association of a point-elastic floor and an area-elastic floor. They combine shock absorption and elasticity properties of these two categories. For example, Subflex Taraflex® Evolution is in this category, by association of Taraflex® Evolution, point elastic floor and Subflex cushioning wood subconstruction with foam.

### For protection

The floor that brings immediate protection on impact to all users when falling, diving or sliding on the floor.

Gerflor offers Taraflex® Comfort a P3 floor with the highest level of comfort on the market.

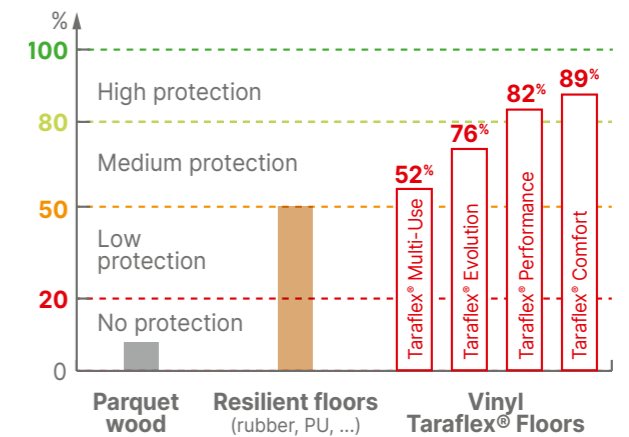

### For safety

Shock absorption **minimises the force** of impact on the body and reduces long term injury risk.

With a complete range of shock absorption P1/P2/ P3, Gerflor provides the right solution and the best safety for every user.

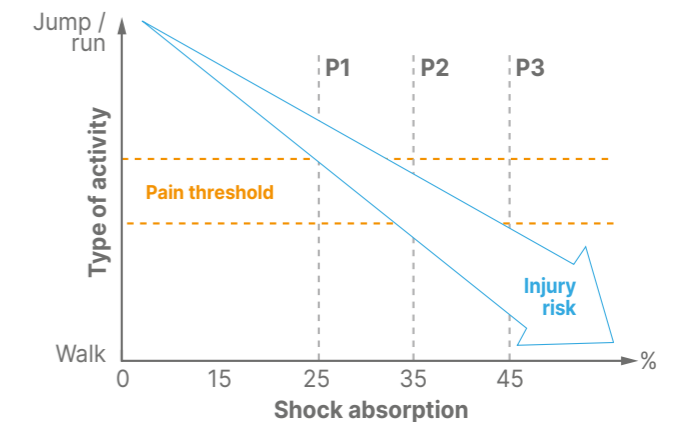

### For durability

Taraflex® technologies ensure long-lasting **High Performance**

Gerflor guarantees the category P1/P2/P3 after 15 years use\*.

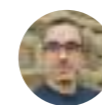

"I have been Product Development Manager at Gerflor for 12 years. My constant objective has always been to meet the needs of the market and ensure the satisfaction of our sports customers. To achieve this, I work closely with the technical teams to design and continuously improve our products. Recently, we developed the new Taraflex® products, taking care to incorporate bio-sourced content while maintaining our quality standards."

R&D - Gerflor

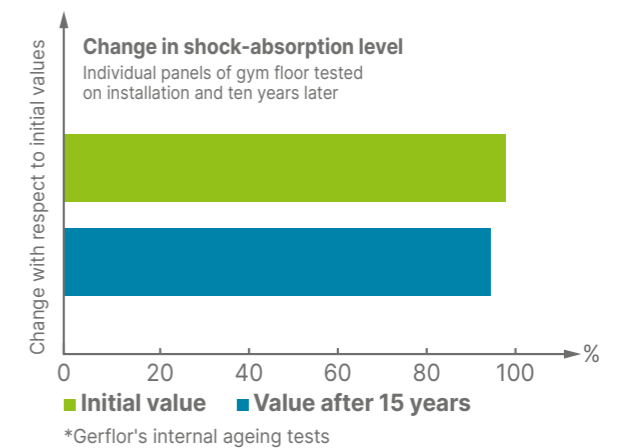

\*Gerflor's internal ageing tests

# Taraflex® Sport Floors

## Why should you choose Taraflex®?

### Sport floors are classified into 2 different levels of versatility:

- Light versatility
- Heavy versatility

Heavy or light versatility is determined by the weight of the sports and extra-sports equipment used and the duration of the load.

### Light Versatility

#### Rule of the light versatility according to the standard EN 14904

- Weight: <10 kg/cm<sup>2</sup>
- Duration of non-sport activities solicitation: 5h



Chair occupied  
up to 100 kg

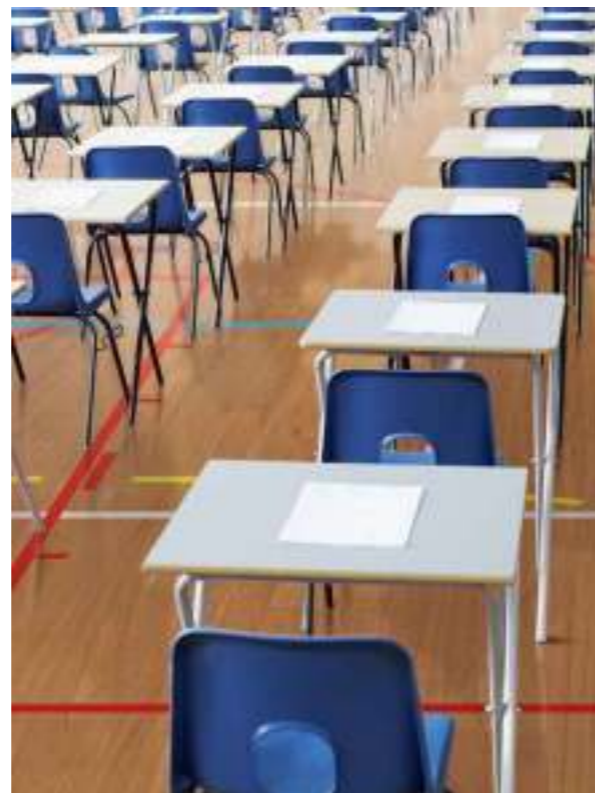

### Heavy Versatility

#### Rule of the heavy versatility

- Weight: 10 to 50 kg/cm<sup>2</sup>
- Duration of non-sport activities solicitation: 12h to 24h



Bleacher  
up to  
1500 kg



Platform  
380 kg



Concert  
scene  
500 kg



Machine on 4 wheels  
up to  
2000 kg



### IPI: Impact Protection Index

**Protection** is the property of the floor that reduces immediate injuries when falling, diving, sliding on the floor for all users (children, adults, athletes...)

**Protection** is not considered by EN 14904 but is an important criteria, as in many instances sports floors are used for educational purposes.

**Gerflor measures protection** with the Impact Protection Index and defines 3 categories of protection:

#### IPI = Impact Protection Index

≤ 50%	low protection
50% < IPI ≤ 80%	medium protection
> 80%	high protection

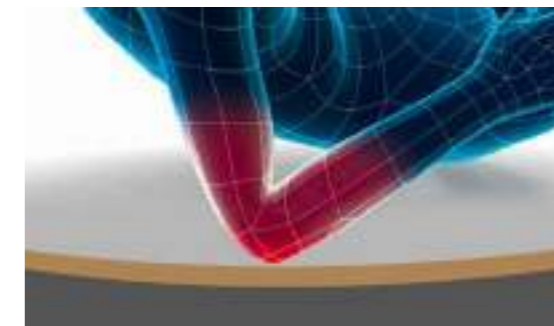

Small surface impact area, **low IPI floors**, high risks of immediate injuries.

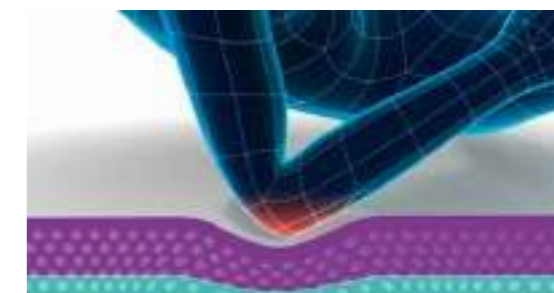

High impact surface area, **high IPI floors**.



### Choosing a sports floor requires a good understanding of the usage of the sports hall:

- Type of users: from children to high level athletes
- Type and variety of sports
- Type of sport equipment: tennis or volleyball posts, gym equipment, ...
- Use for activities other than sport: exams, concerts, requiring other specific equipment

# Taraflex® Sport Floors

## Champions in Sustainability

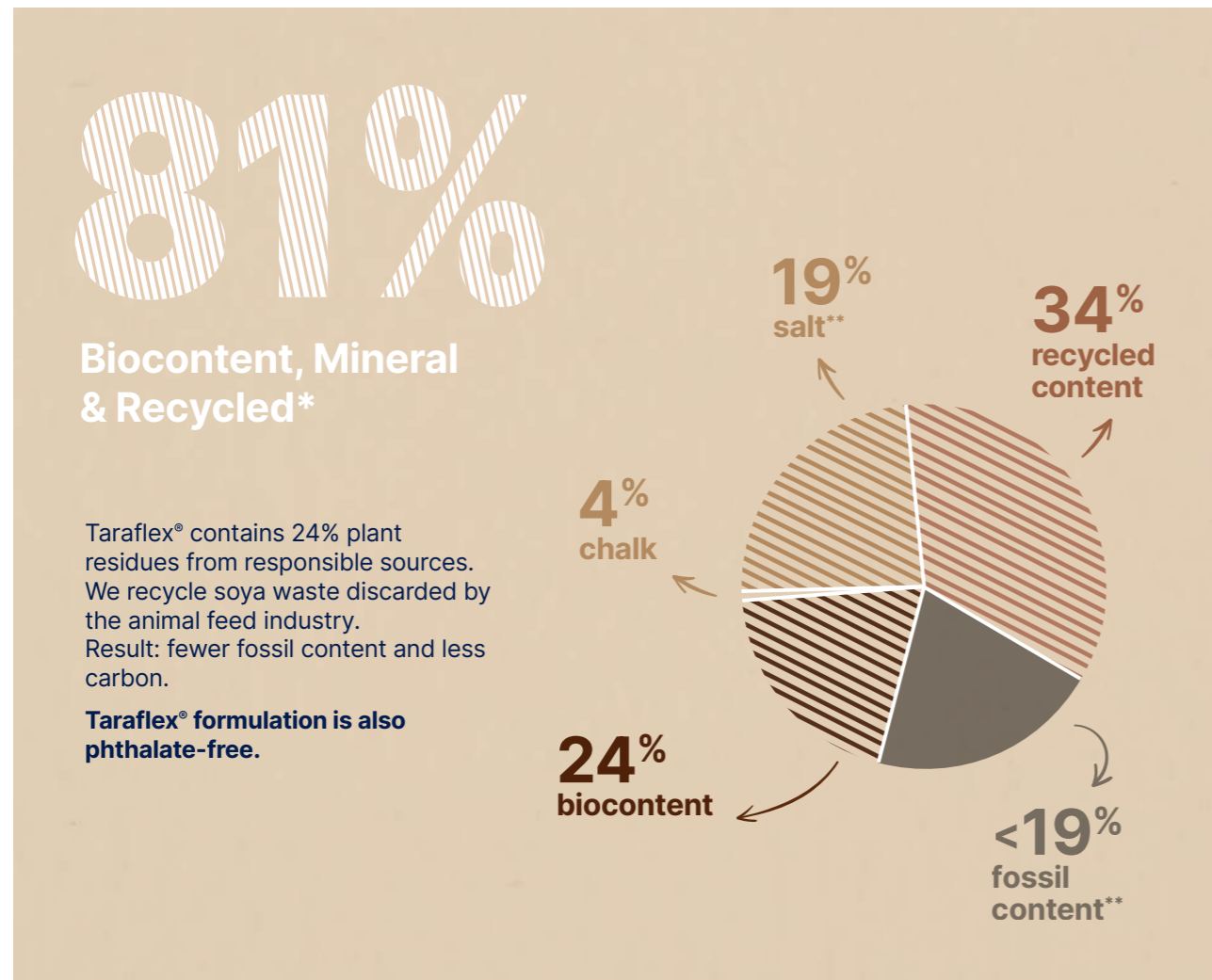

### Best in class carbon footprint



Thanks to 360° eco conception, Taraflex EPD is the lowest of the sports flooring market.

**A good choice for decarbonising your projects.**

### 100 % recyclable



All Gerflor floorings are 100% recyclable and eligible to **Gerflor Second Life collection and recycling program**. Free collection of installation waste is available in 10 countries.

## The secret of Taraflex® Sport Flooring

### 1 ProtecSol®

An intelligent surface with the unique and patented triple action ProtecSol®:

- Best solution to maximise both slide and grip
- A friction-burn free surface, on which the temperature during a fall is reduced by 25%
- Cost effective and easy to maintain

### 2 D-Max™

D-Max™ surface is a UNIQUE complex made of calendered PVC sheets reinforced with a fibreglass grid.

- High durability
- Outstanding dimensional stability

### 3 CXP<sup>COMFORT</sup> HD

Taraflex® CXP-HD dual-density foam provides shock absorption for ideal player protection and safety.

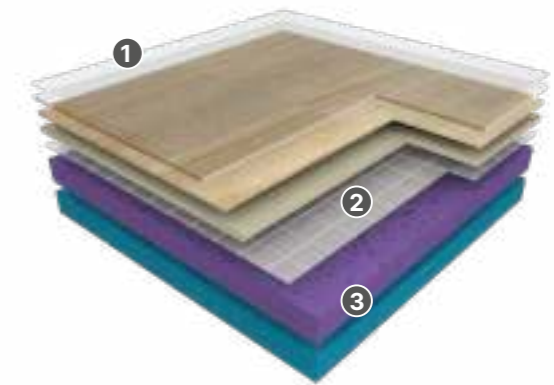

### 4 different foams

Low Density	Density +	Density ++	Density +++
Lightness	Elasticity	Energy restitution	Compactness

### 3 types of products

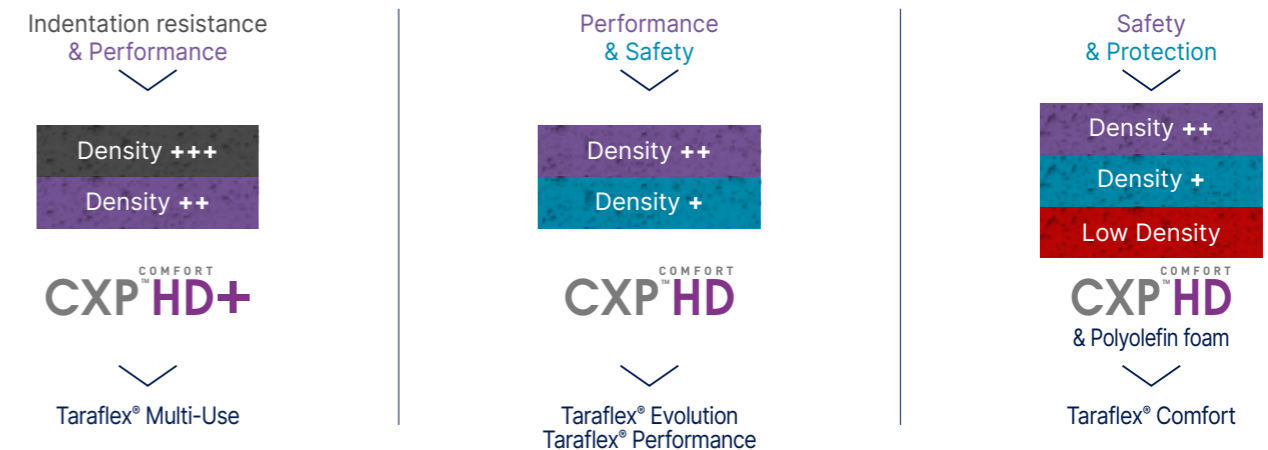

"I'm committed to listening carefully to our customers to find solutions to their problems, while promoting Taraflex®, 'the floor of champions'. Whether young, amateur, professional or senior, I believe that every player has the right to the best possible floor. This conviction has driven my daily work for the past 7 years, to continue to offer excellence and create great experiences of conviviality, pleasure and optimal performance over time on #Taraflex®."

Sports Product Marketing Manager

\*Taraflex® Evolution solid colours  
\*\* Vinyl is made from two primary ingredients: salt (abundant mineral) and ethylene (fossil)

# Taraflex® Sport Floors

How to choose the right floor?

## Multi Sport, Education, Club & Competition

### Taraflex® Evolution

The reference in sports flooring

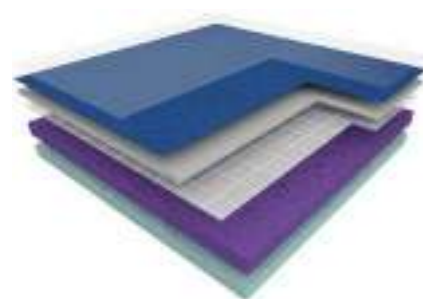

- 7.5 mm** P1
- Natural inside
- Also available in Taraflex® Evolution SL
- DTx** Also available with Dry-Text™ System



### Taraflex® Performance

Best balance of sport performance and safety



- 9 mm** P2
- Natural inside
- Also available in Taraflex® Performance SL
- DTx** Also available with Dry-Text™ System



©VOLLEYBALL WORLD - COURTESY

### Taraflex® Comfort

Maximum protection & safety

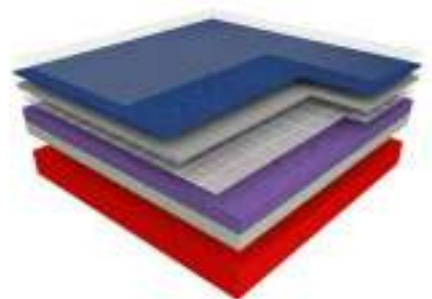

- 12.5 mm** P3
- Natural inside



## Multi Purpose, Sport & Non-Sport Activities

### Taraflex® Surface

Compact surface, to be used alone or on sub-construction\*

\*Meets EN14904 with sub-construction

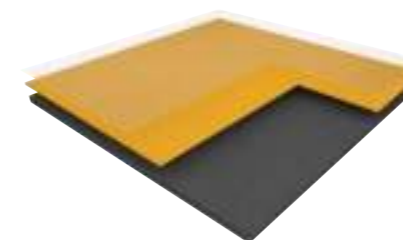

- 2 mm**
- Natural inside



### Taraflex® Multi-Use

Performance & very high indentation resistance

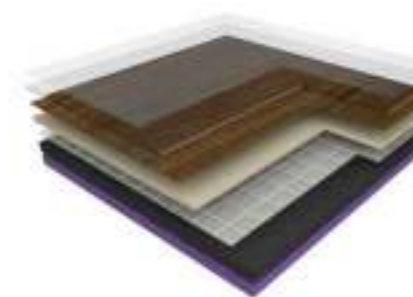

- 6.2 mm** P1
- Natural inside



	Basketball	Volleyball	Handball	Netball	Floorball	Futsal	Table Tennis	Badminton	Multi-sports	Rolling Sports & Wheel sports	Disability sports	Heavy versatility	Light versatility
Taraflex® Evolution (P1)	■	■	■	■	■	■	□	■	■	□	×	×	■
Taraflex® Performance (P2)	□	■	■	■	■	■	×	□	■	□	□	×	□
Taraflex® Comfort (P3)	×	□	□	□	□	□	×	□	■	×	■	×	×
Taraflex® Multi-Use (P1)	□	□	□	□	□	□	■	■	■	■	×	■	■
Taraflex® Surface	■	□	□	□	□	□	□	□	■	■	×	■	■

Installed over undercarriage system

■ = Recommended / □ = Possible / × = Not recommended

# Taraflex® Sport Floors

## Smooth Harmony

Taraflex® Surface, Taraflex® Evolution, Taraflex® Performance, Taraflex® Comfort



Ecru



4345 - Ecru / Y = 52.7

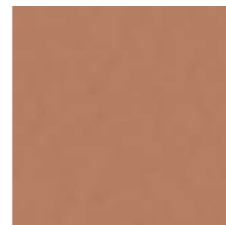

6348 - Clay / Y = 23.1

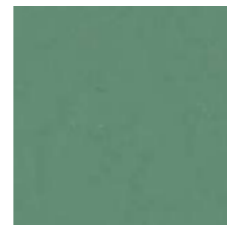

6553 - Fern / Y = 20.9

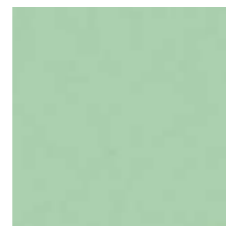

0654 - Sage / Y = 43.6



0047 - Mallow / Y = 41.6



« Sport and well-being has become an essential part of our daily lives, the balance between physical and mental fitness is like a rule of life for some people.

This new palette of softer, more contemporary colours create the right ambience for users looking for places that combine sport and relaxation but also to the expectations of architects for new sports complexes, which are often increasingly integrated into the environment.

The two new shades of green (sage and fern) are much closer to the shades found in nature and can be blend perfectly with our wood designs.

Terracotta (clay) is a colour that has been used for a long time in many sports surfaces such as tennis and athletics and this earthy colour provides a reassuring touch.

We've reworked beige (new ecru) to make them more neutral and blend in with all the other colours. Mauve (mallow) is the palette's funniest, trendiest touch. »

Designer - Gerflor

## Timeless Nature

Taraflex® Surface, Taraflex® Evolution, Taraflex® Performance, Taraflex® Comfort



6350 - Light Cherry / Y = 43.3



Scan scale: 25%



5742 - Wood Oak / Y = 27.8



Scan scale: 25%



5763 - Maple Sun / Y = 40.2



Scan scale: 25%



6379 - Maple Desert / Y = 23.2



Scan scale: 25%



Light Cherry & Wood Oak

# Taraflex® Sport Floors

## Colourful Games

Taraflex® Surface, Taraflex® Evolution, Taraflex® Performance, Taraflex® Comfort



2404 - London Light Blue / Y = 33.8



6431 - Teal / Y = 19.2

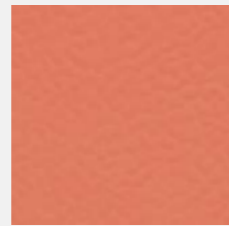

6146 - Coral / Y = 27.8



6038 - Terracotta / Y = 19.9



6445 - Lagoon / Y = 24.9



6570 - Mint Green / Y = 16.6



6211 - Gold / Y = 41.5



6180 - Red / Y = 9.8



6430 - Blue / Y = 8.0

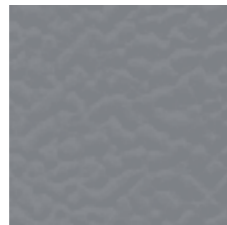

6873 - Anthracite / Y = 20.5



6758 - Silver Gray / Y = 32.6

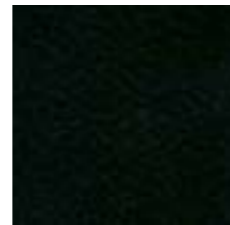

6830 - Black / Y = 3.1



© Volleyball World - Courtesy

Teal / Coral

## Masking designs for multi-use

### Taraflex® Multi-Use



6844 - Black Strips / Y = 14.5



6391 - Maple Stone / Y = 30.6



6373 - Maple Ocean / Y = 21.1



6392 - Maple Earth / Y = 10.2



6379 - Maple Desert / Y = 23.2



2790 - Polished Concrete Dark Grey / Y = 15.3



2791 - Polished Concrete Light Grey / Y = 27.4



6350 - Light Cherry Design / Y = 43.3

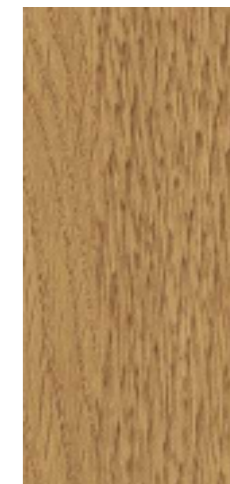

5742 - Wood Oak / Y = 27.8



7762 - Pure Concrete Blue / Y = 12.5



7764 - Pure Concrete Lagoon / Y = 28.7



6445 - Lagoon / Y = 24.9



6873 - Anthracite / Y = 20.5



6180 - Red / Y = 9.8

# Taraflex® Sport Floors

## Specific applications racket sports

- Racket sport floors should offer an excellent compromise between slide and grip for lateral moves, accelerations and changes of direction.
- Gerflor offers a complete range of solutions for racket sports with different types of installation methods (portable and permanent floors) to meet player's expectations and facilities needs.

### Taraflex® Table Tennis

Engineered and developed in partnership with the International Table Tennis federation (ITTF)

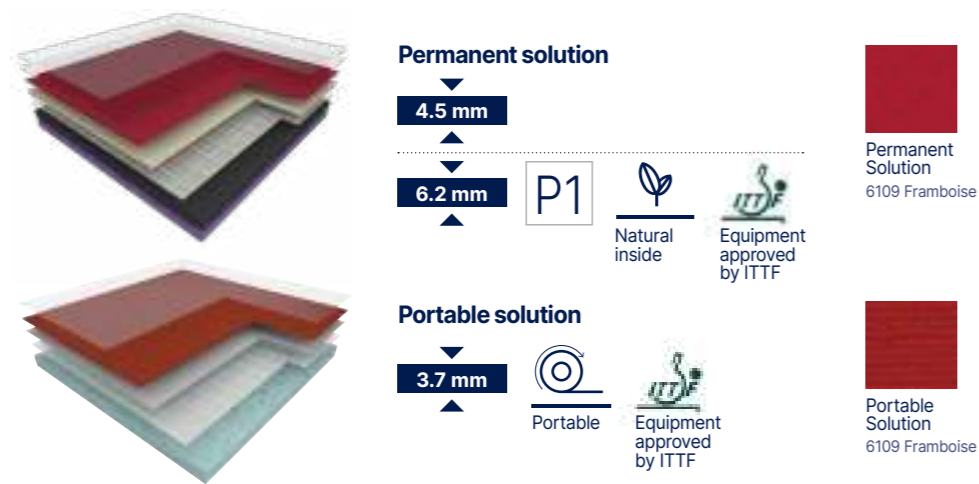

### Taraflex® Badminton

The ultimate floor for badminton movements

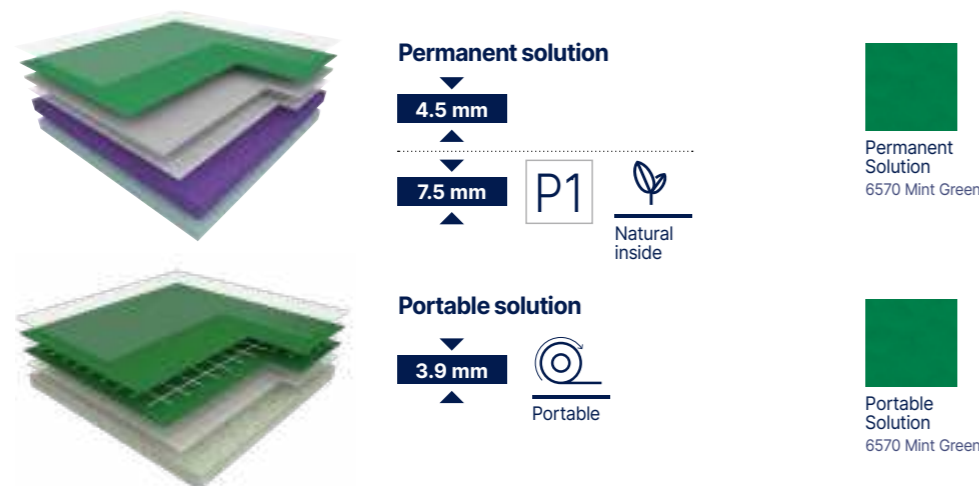

## A sub-construction for each usage

### Subflex **New**

SUBFLEX is a sports sub-construction that can be combined with a floor covering of your choice. It consists of an 18.8mm wooden panel, shock-absorbing and energy-releasing foam, and a protective layer against rising damp. These complete and combined assemblies ensure excellent sporting performance for athletes, as this sub-construction offers unrivalled stability and solidity.

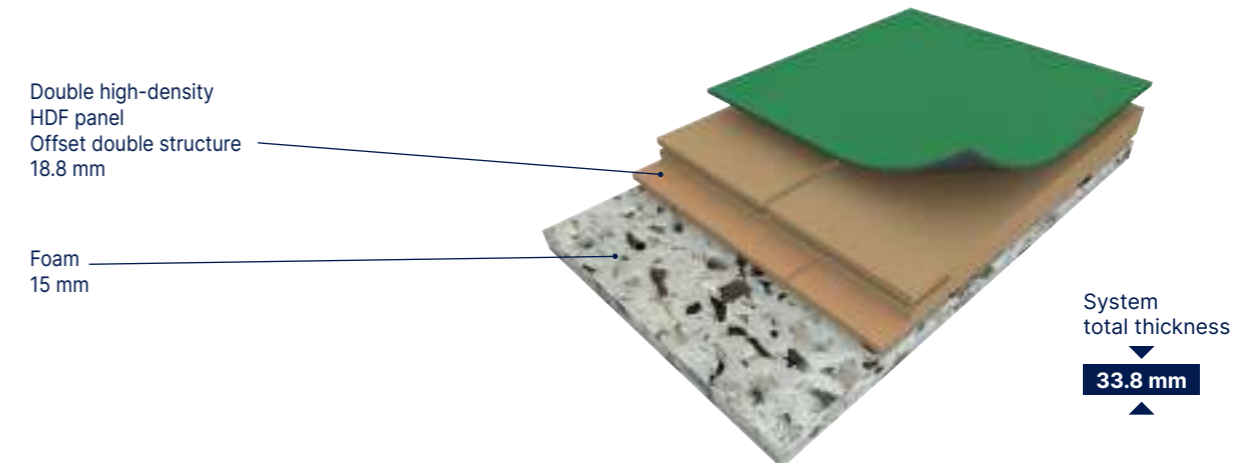

### Subflex benefits



**Resistance against humidity** rises, up to 7%



Wide ranges of designs for an **ultra-realistic wood aspect**



No need to sand or treat joints before surface flooring installation: **easy installation**

Modular installation: **Easy to fix**

GERFLOR SOLUTION



Offset double-layer structure that enables a full assembly coverage: **solidity, stability and superior resistance to static and rolling loads**

Available with Taraflex® Evolution, Taraflex® Surface, Taraflex® Multi-Use, Linodur Sport, Marmorette 3.2.

OTHER MARKET SOLUTIONS



High-density surface with 900 kg/m³ HDF: **resistance to impact, static and rolling loads**



"With SUBFLEX, we've developed a simple, high-performance sub-construction that's easy to install and allows a wide range of sports floors to be combined for an optimised playing experience."

Sports Product Manager

# Taraflex® Sport Floors

## Taraflex® technologies

Gerflor has developed durable technologies to cover all types of installation, responding to the constraints of substrates, such as humidity, for renovation or temporary installation. These technical solutions can be combined with the products in the range to ensure the best performance, while preserving the sporting characteristics of Taraflex® floors.

### Adhesive free sustainable installation

#### Taraflex® SL

SL® is an installation technology that works in conjunction with our Taraflex® floors.

This installation does not require any adhesive meaning an easier, faster and more sustainable installation without compromising sport performances and quality.

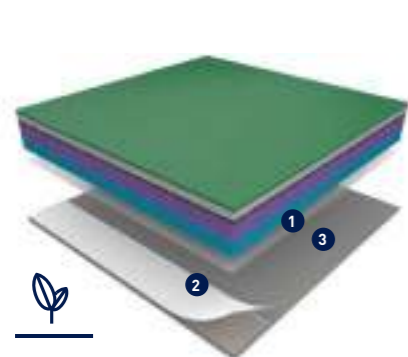

Natural inside

- 1 **Taraflex® sports flooring with reinforced textile backing**  
Improved dimensional stability allowing for the only true adhesive-free sports floor installation including onto damp sub-floors with up to 7%.
- 2 **Long-lasting Tarafix® SL holding strips**  
Strips installed under welded seams and floor perimeter to provide optimal stability and durability.
- 3 **Concrete slab**



Choose the SL solution, a smart choice representing 3 advantages in 1

#### SUSTAINABLE ADHESIVE FREE INSTALLATION

- Eliminating adhesives improves laying comfort and indoor air quality for installers and users
- Reduce the installation time

#### EASY RECYCLING

- Eco-design: SL textile fibers are composed of recycled plastic bottles



- Can easily be reused\* or recycled



#### UNBEATABLE QUALITY & PERFORMANCE

- Same level of quality and performance as traditionally adhered Taraflex®
- High resistance to all sports demands
- Compliant with sub floors with up to 7% of humidity

Available with Taraflex® Evolution and Taraflex® Performance.  
\* Can be reused in a 10% smaller area.

### Solution for damp subfloors

#### Dry-Tex™ System

DryTex® is an installation technology that works in conjunction with our Taraflex® floors. The action between our Gerpur adhesive and a textile backing applied under the CXP-HD foam during the manufacturing process ensures unequalled stability on very damp surfaces.

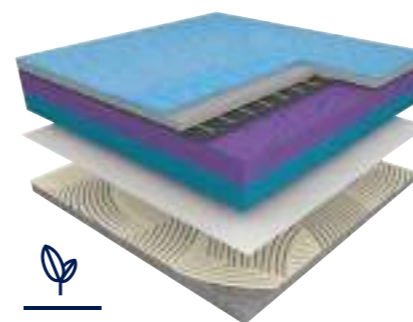

Natural inside

Available with:  
Taraflex® Evolution  
Taraflex® Performance

- **Cost-effective** - no need for additional moisture barriers (DPM's) saving both labour and material costs
- **Time-effective** - no need to wait for the slab to dry out
- **Greater durability and performance** - unbeatable bonding strength to the subfloor

#### Installation criteria:

Moisture	No limit*
Flatness	< 6mm / 3m
Surface	Hydraulic concrete**

\*No surface water on the slab  
\*\*For more information contact us

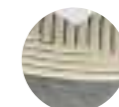

- **DTx™** textile material with CXP HD foam backing
- **GERPUR** proprietary mono component adhesive that reacts to humidity: the higher the moisture, the quicker the bonding!

### Solution for cost-effective renovation works

#### Taraflex® Isolsport

Isolsport is a non-adhesive technical underlay that uses a foam formulation optimised and researched by the R&D department to provide technical and sporting properties suited to all types of application. This solution can be applied to damp substrates and is ideal for renovation.

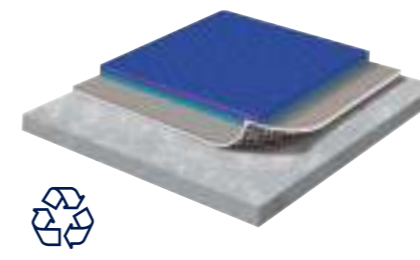

100% recyclable

Available with Taraflex® Evolution,  
Taraflex® Performance, Taraflex® Multi-use (and Recreation 60)

#### For damp surfaces

- Loose lay installation: save money and reduce installation times by leaving the existing floor in place
- Specific texture on the backing to allow humidity to circulate: Minimizes risks from rising dampness
- Provides a complete solution for renovation and build work

#### Installation criteria:

Moisture	RH < 92% (BS 8203) or < 7% humidity (CCM)
Flatness	< 6mm / 3m
Surface	Hydraulic concrete / Porous subfloor

# Taraflex® Sport Floors

## Technical Data

Description	Standard	Requirement	Units	Taraflex® Surface	Taraflex® Multi-Use	Taraflex® Evolution	Taraflex® Performance	Taraflex® Comfort	Taraflex® Badminton			Taraflex® Table Tennis			Taraflex® Bateco	Taraflex® Isolsport	
									Portable	4.5	7.5	Portable	4.5	6.2			
Dry-Tex™ System	-	-	-	-	-			-	-	-	-	-	-	-	-	-	
Taraflex® SL (Sustainable and Looseelay)	-	-	-	-	-			-	-	-	-	-	-	-	-	-	
<b>Product Description</b>																	
Surface treatment	-	-	-	Triple-Action ProtecSol®	Triple-Action ProtecSol®	Triple-Action ProtecSol®	Triple-Action ProtecSol®	Triple-Action ProtecSol®	Triple-Action ProtecSol®	PUR Protect®	Triple-Action ProtecSol®	Triple-Action ProtecSol®	PUR Protect®	Triple-Action ProtecSol®	-	-	
Surface complex	-	-	-	D-Max™	D-Max™	D-Max™	D-Max™	D-Max™	100% Pur PVC	100% Pur PVC	D-Max™	100% Pur PVC	100% Pur PVC	D-Max™	-	-	
Foam	-	-	-	-	CXP-HD +™	CXP-HD™	CXP-HD™	CXP-HD™	CXP	CXP	CXP-HD™	CXP	CXP	CXP-HD+™	-	-	
Thickness	EN ISO 24346	-	mm	2	6.2	7.5	9	12.5	3.9	4.5	7.5	3.7	4.5	6.2	1.5	1.65	
Weight	EN ISO 23997	-	kg/m²	2.7	4.2	4.7	5.2	5.1	1.95	2.6	4.7	1.9	2.6	4.2	2.05	1.35	
Length*	EN ISO 24341	-	lm	26.5 Max	26.5 Max	26.5 Max	26.5 Max	26.5 Max	16 STD	26.5 Max	26.5 Max	16 STD	26.5 Max	26.5 Max	45 Max	45 Max	
Width	EN ISO 24341	-	lm	1.5	1.5	1.5	1.5	1.5	3 x 2.7	1.5	1.5	1.5	1.5	1.5	1.5	2	
<b>Sport Properties</b>																	
Shock absorption	EN 14808	≥ 25	%	-	P1	P1	P2	P3	-	-	P1	-	-	P1	-	-	
Vertical deformation	EN 14809	≤ 3.5	mm	≤ 2	≤ 2	≤ 2	≤ 3	≤ 3.5	≤ 2	≤ 2	≤ 2	≤ 2	≤ 2	≤ 2	-	-	
Sliding coefficient	EN 13036-4	80 to 110	-	80 to 110	80 to 110	80 to 110	80 to 110	80 to 110	80 to 110	80 to 110	80 to 110	80 to 110	80 to 110	80 to 110	-	-	
Ball bounce	EN 12235	≥ 90	%	≥ 90	≥ 90	≥ 90	≥ 90	≥ 90	-	≥ 90	≥ 90	-	≥ 90	≥ 90	-	-	
<b>Technical Characteristics</b>																	
Abrasion resistance	EN ISO 5470-1	≤ 1000	mg	≤ 350	≤ 350	≤ 350	≤ 350	≤ 350	≤ 350	≤ 350	≤ 350	≤ 350	≤ 350	≤ 350	≤ 300	-	
Impact resistance	EN 1517	≥ 8	N/m	≥ 8	≥ 8	≥ 8	≥ 8	≥ 8	-	-	≥ 8	-	-	≥ 8	-	-	
Indentation resistance	EN 1516	≤ 0.5	mm	≤ 0.5	≤ 0.5	≤ 0.5	≤ 0.5	≤ 0.5	≤ 0.5	≤ 0.5	≤ 0.5	≤ 0.5	≤ 0.5	≤ 0.5	≤ 0.5	≤ 0.5	
<b>Classification</b>																	
Fire	EN 13501-1	-	-	B <sub>fl</sub> -s1	C <sub>fl</sub> -s1	C <sub>fl</sub> -s1	C <sub>fl</sub> -s1	C <sub>fl</sub> -s1	B <sub>fl</sub> -s1	C <sub>fl</sub> -s1	C <sub>fl</sub> -s1	C <sub>fl</sub> -s1	C <sub>fl</sub> -s1	C <sub>fl</sub> -s1	C <sub>fl</sub> -s1	B <sub>fl</sub> -s1	C <sub>fl</sub> -s1
Anti-bacterial activity (E. coli - S. aureus - MRSA) <sup>(1)</sup>	ISO 22196	-	-	> 99% inhibits growth						> 99% inhibits growth							
<b>CE Marking</b>																	
	EN 14 904	-	-	Fire Sliding Coefficient Abrasion Resistance Rolling load Resistance	Fire Shock Absorption Sliding Coefficient Abrasion Resistance Rolling load Resistance	Fire Sliding Coefficient Abrasion Resistance Rolling load Resistance	Fire Sliding Coefficient Abrasion Resistance Rolling load Resistance	Fire Sliding Coefficient Abrasion Resistance Rolling load Resistance	Fire Sliding Coefficient Abrasion Resistance Rolling load Resistance	Fire Sliding Coefficient Abrasion Resistance Rolling load Resistance	Fire Sliding Coefficient Abrasion Resistance Rolling load Resistance	Fire Sliding Coefficient Abrasion Resistance Rolling load Resistance	Fire Sliding Coefficient Abrasion Resistance Rolling load Resistance	Fire Sliding Coefficient Abrasion Resistance Rolling load Resistance	Fire	Fire	

The proposed specifications fall within the tolerance limits usually accepted in this sector whilst still complying with standards.

(1) The implementation of an effective cleaning method is the best defence against infection

\* For different roll lengths please contact us

### INSTALLATION ON DAMP SUBFLOOR

Gerflor provides installation on Isolsport (free floating underlay) or Taraflex® Dry-Tex™ System or Taraflex® SL.

Please contact your sales representative for more information.

# Taraflex® Sport Floors

Innovative personalized services to make your floor unique

## My Taraflex®



Personalize your sports floor using the digital printing process

- **Choose from collection**  
choose one of our designs from our catalogue (examples shown below)
- **Change colour**  
recolour the standard design of your choice
- **Customise**  
create your own design

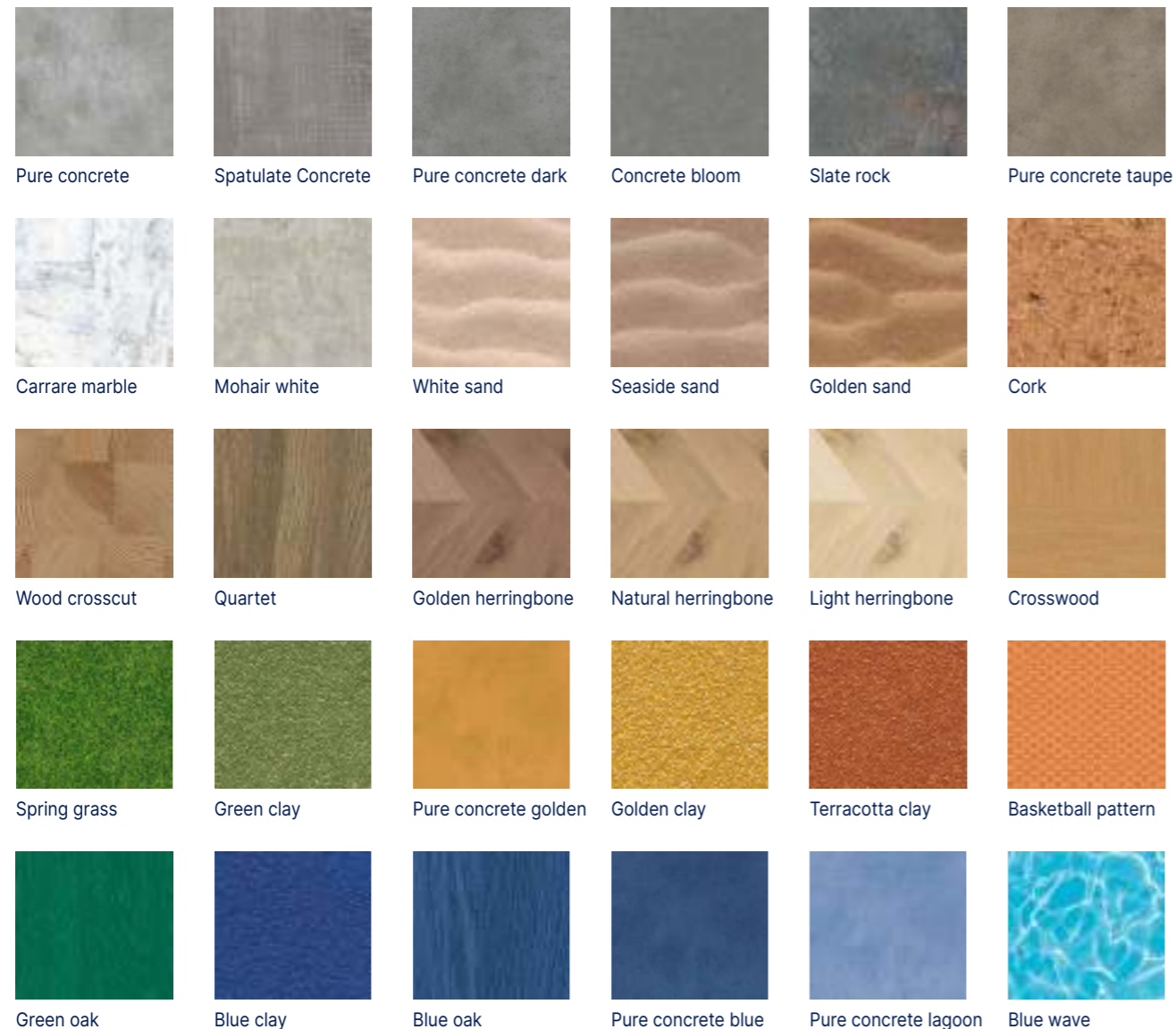

## My Logo

For a stunning result

Thanks to the waterjet cutting technology, **customize your floor** with your city or club colours. For further information, please contact your local Gerflor representative.



## 3D court designer

This intelligent tool lets you customize the sports surface of your choice and the surrounding environment in 3 dimensions to test different pitch configurations.



- 1 Choose your surface: monosport or multisports
- 2 Choose your colours
- 3 Visualise your sport hall

Available on: [courtdesigner.gerflor.com](http://courtdesigner.gerflor.com)

## Interior designer

For a realistic view of your environment

This tool lets you test different sports floors in 2 dimensions with all the colours available in the range. You can also upload your own photo.



- 1 Download your picture and include the floor
- 2 Or change the floor colours in selected pictures
- 3 Visualise your sport hall

Available on: [interiordesigner.gerflor.com](http://interiordesigner.gerflor.com)

# Taraflex® Sport Floors

A wide range of complementary solutions

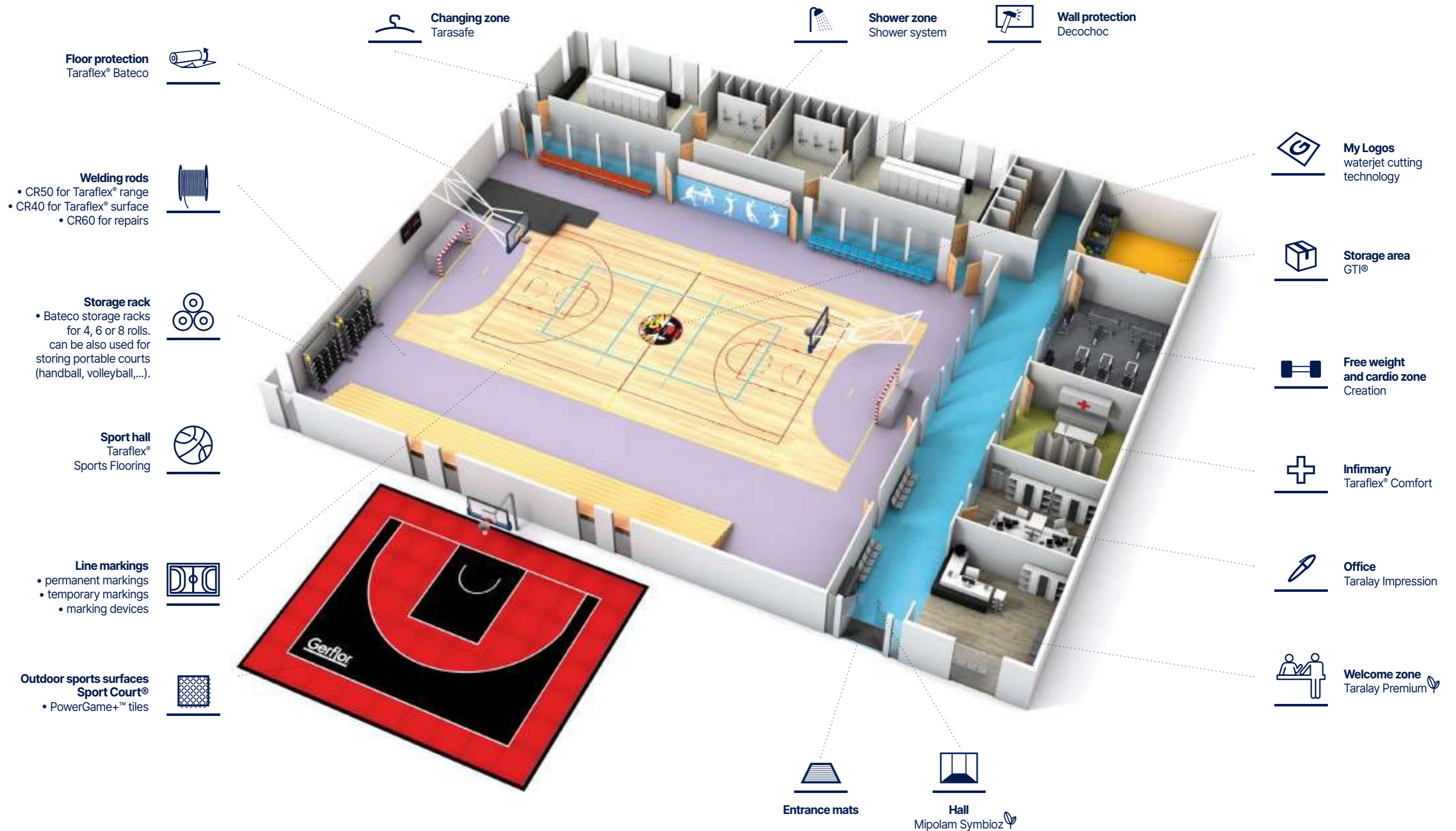

# Connor Sports® Aspire I

## Engineered wood Flooring Systems



## Where Champions Play™

### Top competitions take place on Connor Sports®

#### BASKETBALL

- ▶ 2020 Olympic Games (Tokyo)
- ▶ 2019 FIBA World Cup (China)
- ▶ 2016 Olympic Games (Rio)
- ▶ NCAA Final Four since 2006 (USA)



## Champions deserve exceptional sport surface



### So we select exceptional maple lumber for them

Connor Sports® hand selects north american maple trees grown north of the 35<sup>th</sup> parallel, where the shorter growing season produces a more dense and uniform woodgrain excellent for sports flooring.



Since its establishment in 1897, the Maple Flooring Manufacturers Association (MFMA) is the authoritative source of technical and general information about maple flooring and related sports flooring systems. Connor Sports® is a charter member of the MFMA and the 1<sup>st</sup> member of that group to be certified by the Rainforest Alliance.



Connor Sports® is proud to be the only ZeroWaste company in the sports flooring industry. Recycling, avoiding waste, developing innovative technology and a strong environmental consciousness are a major part of Connor Sports® corporate policy.



Connor Sports® works with FSC (Forest Stewardship Council®). This organization oversees high conservation value forest and protects the communities and indigenous people that rely on the forest. FSC ensures that everyone delivers the most environmentally friendly product.

## Champions of sport

### Hardwood systems for professional teams

More than half of the teams in the NBA have purchased a Connor Sports® hardwood system:



More information on [gerflor.com](http://gerflor.com)

# Connor Sports® Aspire I

Designed to perform

## High-Performance Structure

With durability in mind, the **Connor Sports® Aspire I** was developed by listening to what the market needs. The top 14 mm thick engineered wood board is made with three strips of European Oak in the top layer, while the cross-layered construction of the board ensures a high level of dimensional stability. Thanks to its factory-applied varnish, it also offers easy maintenance and long-lasting appearance.

### Sport Varnish

- Compatible with **EN 14904** Factory applied ensuring high resistance to abrasion, scratches.

### Flooring (14mm)

- Solid oak wood **3.5mm** 3-strip wide engineered wood boards, with cross layer construction offering high level dimensional stability.

### Premium pads (12mm)

- **12mm** Aspire pads Premium resilient pads provide exceptional cushioning under heavy impacts, enhancing player comfort and safety throughout the game.

### Subfloor (24mm)

- Double plywood **2x12mm** Double plywood (2x12mm) structure offering a greater stability of the floor and increased resistance to static and rolling loads.



## Key points

**3.5mm**  
Solid Wood

**>55%**  
Schock  
Absorption

**10 YEARS**  
warranty

**A4**  
category



Top view: Oak Standard grade

## Technical data

### Wall base detail

- 1 3 Strips Oak engineered board (14mm)
- 2 Plywood panels 2 Layers (12mm)
- 3 Aspire resilient pads (12mm)
- 4 Vapour Barrier
- 5 Vented Cove Base (76mm x 1220mm)
- 6 Expansion Space

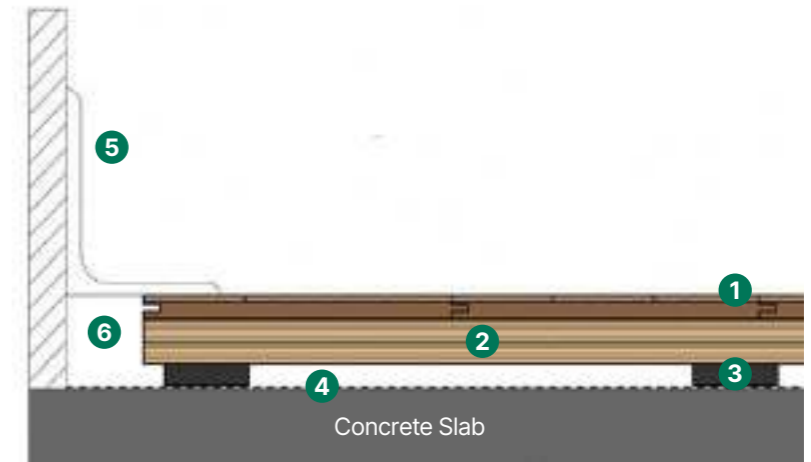

### Product characteristics

Performance	Standard	Requirement	Unit	Results
Thickness	EN 428	-	mm	50
Shock absorption	EN 14808	≥ 25	%	≥ 55
Vertical deformation	EN 14809	≤ 5	mm	≤ 5
Sliding coefficient	EN 13036-4	80 to 110	-	80 to 110
Ball bounce	EN 12235	≥ 90	%	≥ 90
Abrasion resistance	EN ISO 5470-1	≤ 0.08	g	≤ 0.08
Impact resistance	EN 1517	≥ 8	N/m	PASS
Indentation resistance	EN 1516	≤ 0.5	mm	PASS
Fire	EN 13501-1	-	-	



Fire  
Shock Absorption  
Sliding Coefficient  
Resistance to rolling load  
Resistance to wear

Installation informations: find all details on our installation guidelines.

# Sport Court® Outdoor Surfaces

Gerflor, Where Champions Play™

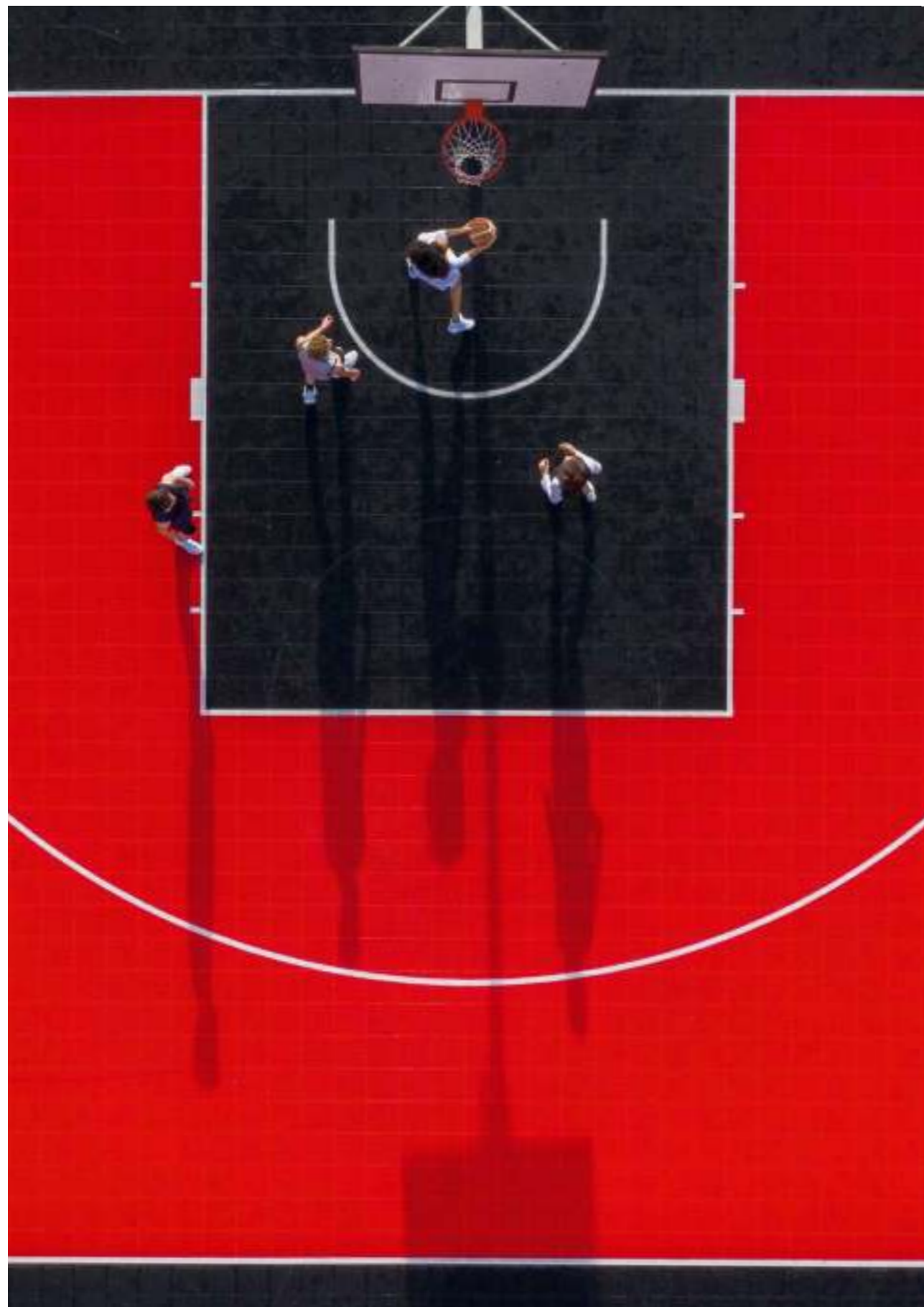

## Sharing more than sport!

### Bring people together for unforgettable moments and lifetime memories

With our modular PowerGame+ tiles, we offer everyone the opportunity to share such memorable sport and recreational experiences.

Our premium surfaces are not only fun, great-looking and safe to play on, but they can also be easily installed in all facilities. You can be sure you're providing the ideal playing outdoor surface for every practice and ambitions, from children to champions.

## Designed for multi-sports

Sport Court® surfaces are designed for a wide variety of sports. All game courts can be easily configured to accommodate basketball, futsal, handball, tennis and more, without compromising on playability or safety.

A number of temporary or permanent applications are possible, from multi-sport school facilities to multi-use game areas to all kinds of sporting events.



Event-based courts



School facilities



Multi-Use Game Areas

# Sport Court® Outdoor Surfaces

They trust us

## Partner of sports federations

Sport Court® surfaces are used at the highest levels of competition by leading sports federations around the world. Our courts are perfect for both temporary events and permanent installations.

**150 000**  
courts installed since 1974



## Long-lasting aesthetics

Design a court that makes an impression. With a selection of 10 fade-resistant tile colours, you have more ways to customise the look of your playing surfaces to fit your requirements, whether you want a fun colourful court, or to customise it with your company's or school's colours.

## Choose your colours

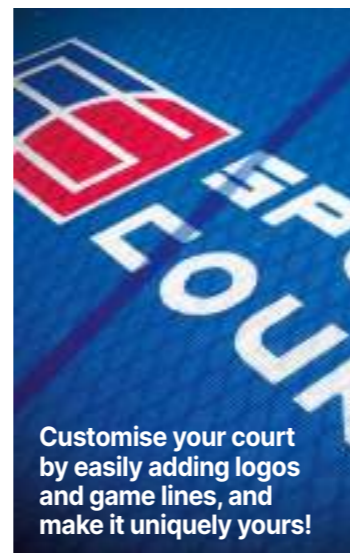
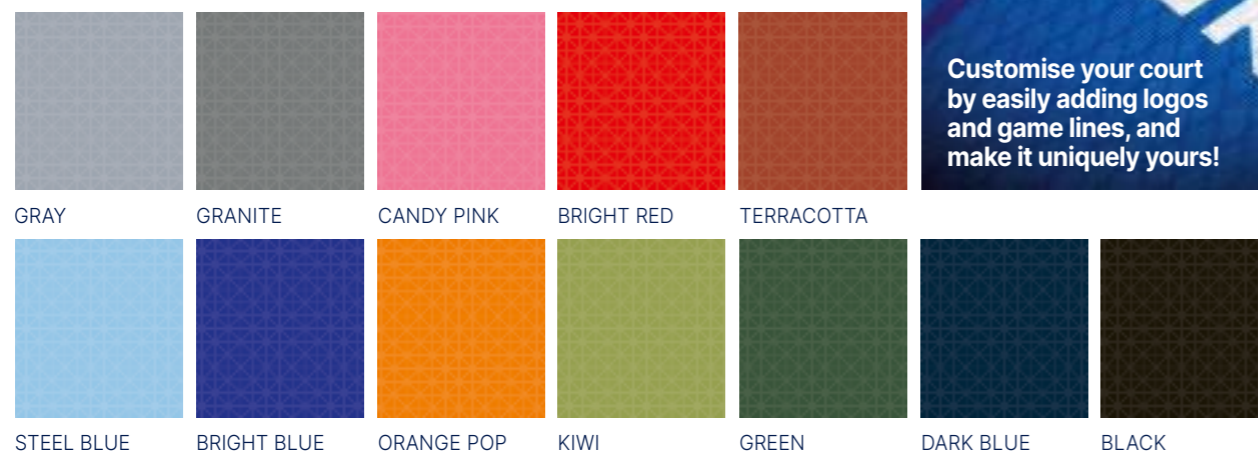

Customise your court by easily adding logos and game lines, and make it uniquely yours!

## Optimal playability and safety

Powergame+ tiles provide exceptional protection against abrasion, head injuries and joint strain. Extensive third-party testing ensures that athletes of any age remain safe while playing and competing on Sport Court® surfaces.

## Accomodate many sports with unmatched playability and safety



## Powergame+ enhances game experience

- Highly versatile multisport surface
- Same dribbling response as a hardwood flooring
- Remarkably stable surface

## Powergame+ provides a unique balance between safety, comfort and durability

- High tile stability optimises ball rebound and game performance
- Improved water drainage enables faster drying and playability after rain
- Low skin abrasion protects players when falling without compromising on traction



## Superior Impact Protection

A head impact from just 10 cm above a concrete surface can cause a concussion. Sport Court® tiles are significantly more forgiving, with PowerGame+ reducing the likelihood of a serious head injury from a fall of 50 cm

Critical Fall Height is a test used in conjunction with the European Standards EN 1177-2018, used for evaluating playground surfaces, such as sand, wood chips, resilient rubber and asphalt.

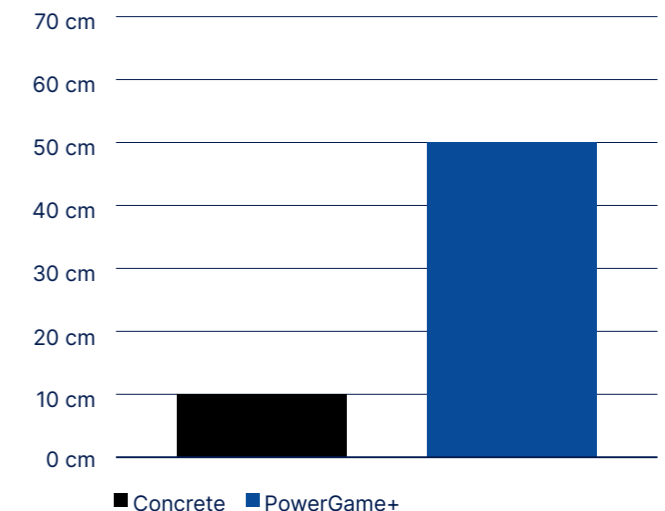

# Sport Court® Outdoor Surfaces

Save time and money

## Easy installation and maintenance

The simple and strong interlocking system enables the installation of a 1,000 sqm court in 4h



**1,000M<sup>2</sup> COURT = 4H COURT INSTALLATION + 2H GAME LINE PAINTING**

WITH A 4-PERSON TEAM

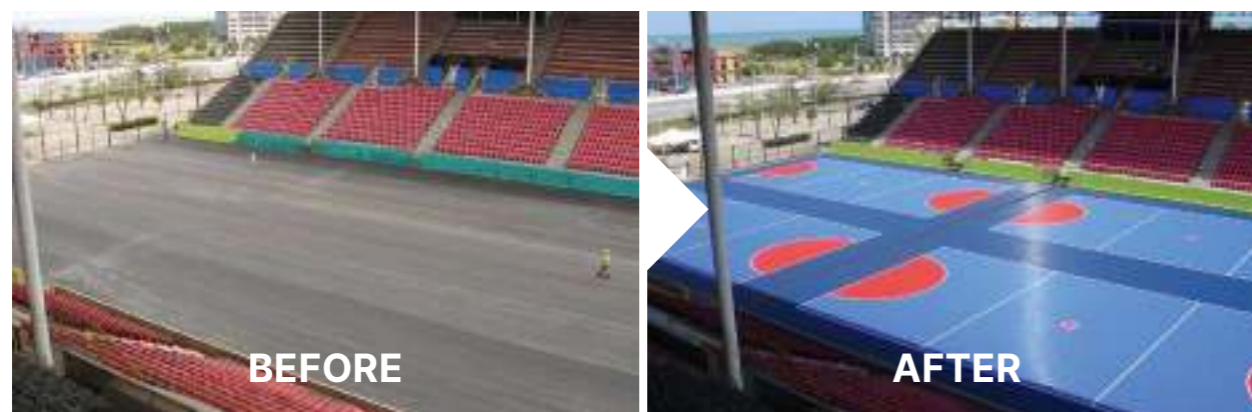

The next step in multi-sports outdoor surfacing

## POWERGAME+

Made in France  
Designed to provide the highest levels of safety and playability. PowerGame+ is the perfect choice for your facility.

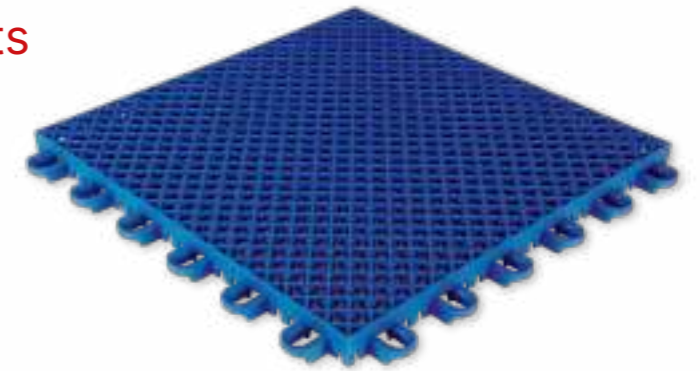

### Long-lasting aesthetics



**UV protection**  
Outstanding colour durability

### Durabilité et confort de jeu



**Wide and deep connection loops**  
High stability and durability over installation and removal, safety of the players

### Optimal playability

#### Optimal grid design

Double-grid structure for faster drying, reduced water rebound, and optimal safety



**Top-grid:**  
"Open Diamond" design  
For better drainage



**Lower grid:**  
"Saddle" Shape  
To prevent water retention

A greater court with finishing profiles

Discover our complete range of finishing profiles, adapted to every court configuration.

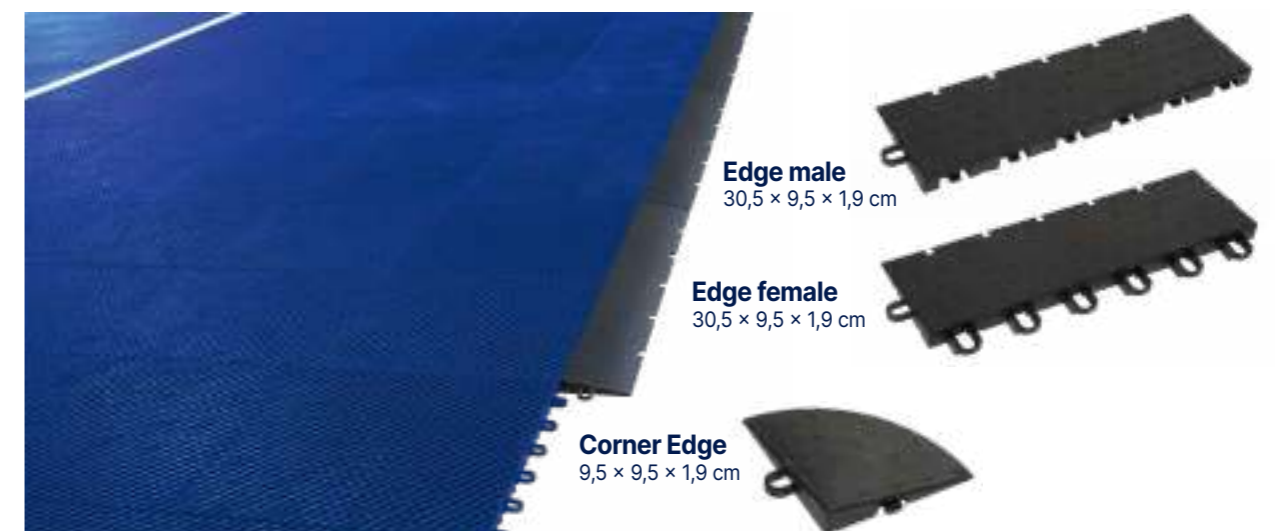

### Polypropylene Profiles

- Easy and fast installation
- Beautiful additional elements to finish the court

# Linoleum Sports Floorings

## Colorette Sport / Linodur Sport / Marmorette Sport 3.2 mm



### Colorette Sport

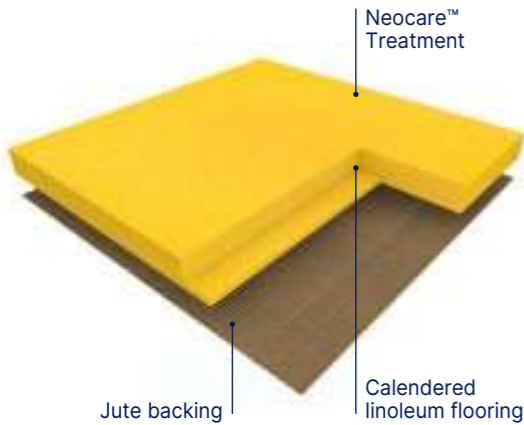

**COLORETTE SPORT** is a calendered linoleum compact floorcovering in sheet, 2 m wide, compatible with Gymflex II rubber underlay for a point elastic installation. Its weight is 4700 gr/sqm in 4.0 mm. It features a speckled design. It is composed of 98% natural materials (linseed oil, wood flour, resins, cork, minerals and jute fabric) among which 79% are rapidly renewable. The flooring is 100% recyclable. The flooring is produced with Neocare™ solvent-free surface treatment, an exclusive photo-cured acrylate based lacquer surface treatment obtained by triple laser UV cross linking. Neocare™ offers excellent scratch resistance as well as resistance to chemicals found in aggressive environments such as bleach, hydro alcoholic solutions, Betadine and Eosin as well as markers making maintenance easier and increasing the life of the flooring. This treatment avoids performing any polishing throughout the lifetime of the product. It can however be polished following usual recommendations and according to the customer's wishes. The flooring is 100% recyclable, 100% controlled, is REACH compliant and rated Cfl-s1 for fire resistance. The product also benefits from international certifications such as Floorscore® and Blue Angel (emissions). Designed and manufactured in a sustainable way in a plant awarded with ISO 9001 (quality), ISO 14001 (environment) and ISO 50001 (energy) certifications, the flooring is certified "Cradle to Cradle Silver".

### Linodur Sport

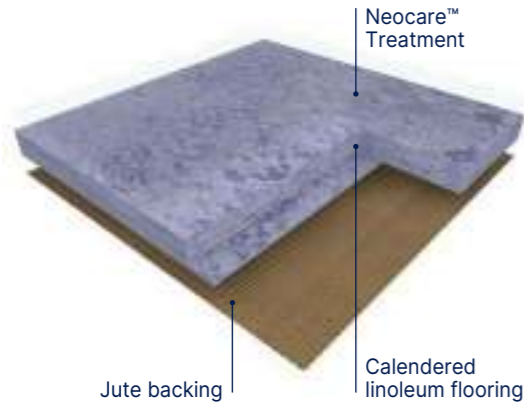

**LINODUR SPORT** is a calendered linoleum compact floorcovering in sheet, 2 m wide, compatible with Gymflex II rubber underlay for a point elastic installation. Its weight is 4700 gr/sqm in 4.0 mm. It features a modern design with a fine grain effect. It is composed of 98% natural materials (linseed oil, wood flour, resins, minerals coffee chaff and jute fabric) among which 83% are rapidly renewable. The flooring is 100% recyclable and contains up to 32% recycled content. The flooring is produced with Neocare™ solvent-free surface treatment, an exclusive photo-cured acrylate based lacquer surface treatment obtained by triple laser UV cross linking. Neocare™ offers excellent scratch resistance as well as resistance to chemicals found in aggressive environments such as bleach, hydro alcoholic solutions, Betadine and Eosin as well as markers making maintenance easier and increasing the life of the flooring. This treatment avoids performing any polishing throughout the lifetime of the product. It can however be polished following usual recommendations and according to the customer's wishes, 100% controlled, is REACH compliant and rated Cfl-s1 for fire resistance. The product also benefits from international certifications such as Floorscore® and Blue Angel (emissions). Designed and manufactured in a sustainable way in a plant awarded with ISO 9001 (quality), ISO 14001 (environment) and ISO 50001 (energy) certifications, the flooring is certified "Cradle to Cradle Silver".

### Marmorette Sport 3.2 mm

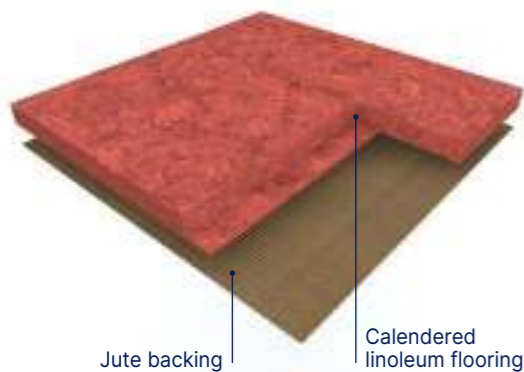

**MARMORETTE SPORT 3.2 mm** is a calendered linoleum compact floorcovering in sheet, 2 m wide. Its weight is 3800 gr/sqm in 3.2 mm. It features a marbled design. It is composed of 98% natural materials (linseed oil, wood flour, resins, minerals and jute fabric) among which 83% are rapidly renewable. The flooring is 100% recyclable, up to 40% recycled content, 100% controlled, is REACH compliant and rated Cfl-s1 for fire resistance. The product also benefits from international certifications such as Floorscore® and Blue Angel (emissions). Designed and manufactured in a sustainable way in a plant awarded with ISO 9001 (quality), ISO 14001 (environment) and ISO 50001 (energy) certifications, the flooring is certified "Cradle to Cradle Silver".

## Colorette Sport / Linodur Sport / Marmorette Sport 3.2 mm



			Colorette Sport	Linodur Sport	Marmorette Sport 3.2 mm
<b>Description</b>					
Total thickness	EN ISO 24346	mm	4.0	4.0	3.2
Backing	-	-	Jute fabric	Jute fabric	Jute fabric
Weight	EN ISO 23997	g/sqm	4700	4700	3800
Width of sheet	EN ISO 24341	cm	200	200	200
Length of sheet	EN ISO 24341	m	Ca. 28	app. 28	app. 28
Material content	-	-	98% natural materials (bio-based & mineral), among which 79% are rapidly renewable, 100 % recyclable	98% natural materials (bio-based & mineral), among which 83% are rapidly renewable, recycled content up to 32%, 100 % recyclable	98% natural materials (bio-based and mineral) among which 83% are rapidly renewable. 100 % recyclable, contains up to 40 % recycled
<b>Classification</b>					
Norm / Product specification	-	-	EN 14904 / DIN V 18032-2 2001/04	DIN EN 14904 DIN V 18032-2	EN 14904 / DIN 18032-2
European classification	EN ISO 10874	class	23 / 34 / 43	23 / 34 / 43	23 / 34 / 43
Fire rating	EN 13501-1	class	Cfl-s1 <sup>(1)</sup>	Cfl-s1 <sup>(1)</sup>	Cfl-s1 <sup>(1)</sup>
Dynamic friction coefficient	DIN V 18032-2 2001/04	μ	0.4 - 0.6 OK	0.4 - 0.6 OK	0.4 - 0.6 μ - OK
Sliding Coefficient	EN 13036 - 4	-	80 - 110 OK	80 - 110 OK	80-110 - OK
Impact sound insulation	EN ISO 717-2	dB	8	8	6 dB
<b>Performances</b>					
Residual indentation	EN ISO 24343-1	mm	≤ 0.20	≤ 0.20 OK	≤ 0.15
Indentation resistance	EN 1516	mm	≤ 0.5 OK	≤ 0.5 OK	-
Slip resistance	EN 16165 App B (DIN 51130)	class	R10	R10	-
Colour fastness	EN ISO 105 - B02	degree	≥ 6	≥ 6	≥ 6
Point contact resistance	VDE 0100	-	-	-	p ≥ 0.20 OK
Light reflection	DIN 5036-3	-	ρ ≥ 0.20 OK (except colours 1004,1080 und 1118)	ρ ≥ 0.20 OK (except colours 1013,1024,1059,1073,1081)	-
Static electrical propensity	EN 1815	kV	≤ 2	≤ 2	app. 2.0
Castor chair test (Type W)	ISO 4918	-	OK	OK	OK
Thermal resistance	EN 12667	(m <sup>2</sup> K)/W	0.023	0.023	0.018
Thermal conductivity	EN ISO 10456	W/(m.K)	0.17	0.17	0.17
Chemical products resistance	EN ISO 26987	class	Excellent <sup>(2)</sup>	Excellent <sup>(2)</sup>	OK
Impact resistance	EN1517	N/m	≥ 8 OK	≥ 8 OK	-
Abrasive wear resistance	EN ISO 5470-1	mg	≤ 1000 OK	≤ 1000 OK	-
Gloss level	EN ISO 2813	-	OK	OK	-
Surface Treatment	-	-	NEOCARE™	NEOCARE™	-
Anti-viral activity (Human coronavirus) after 5 h <sup>(3)</sup>	ISO 21702	-	> 98.65 % virucidal activity	> 98.65 % virucidal activity	-
Anti-bacterial activity (E. coli - S. aureus - MRSA) <sup>(3)</sup>	EN ISO 22196 (JIS Z 2801)	-	> 99.99% inhibits growth after 24h	> 99.99% inhibits growth after 24h	-
Indoor air quality (TVOC after 28 days)	EN 16516	μg/m <sup>3</sup>	< 30	< 50	-
<b>Circular Economy</b>					
Certification	Cradle to Cradle	-	Silver	Silver	Silver
<b>CE Marking</b>					
CE	EN 14904: 2006	-			

(1) Glued according to certificate.

DOP numbers available from your local branch.

(2) Resistant to non-colouring alcohol-based sanitisers, domestic chemicals and acid and alkaline solutions for short periods.

(3) The implementation of an effective cleaning method is the best defence against infection.

⚠ Depending on light exposure, the product color can vary, due to linoleum natural oxidization process. This process is reversible. We recommend that the samples be exposed to sunlight for several hours prior to making a final color choice.

# Linoleum Sports Floorings

## Linodur Sport

Compact Neocare™ 4 mm



## Colorette Sport

Compact Neocare™ 4 mm



## Marmorette Sport 3.2 mm

Compact 3,2 mm



## Linogym II - 10 mm

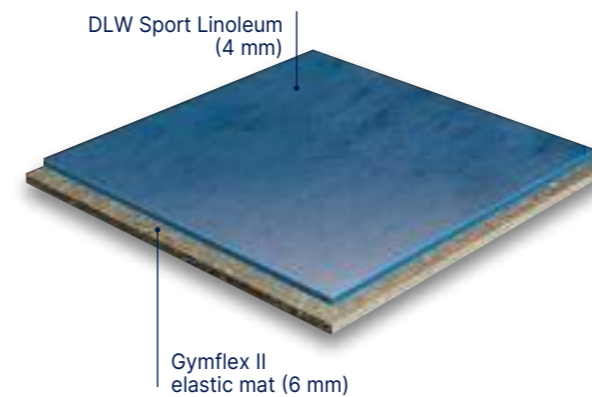

Ideally suited for kindergardens. With a 26% impact absorption rate, **LINOGYM II SYSTEM** provides outstanding cushioning qualities.

**THE LINOGYM II SYSTEM** – point-elastic flooring!

**LINOGYM II SYSTEM** brings together the best of Sport Linoleum and elastic matting. It consists of the 6 mm elastic matting Gymflex II on which a 4 mm Sports Linoleum (Linodur or Colorette) will be installed. With a 26% impact absorption rate, **LINOGYM II SYSTEM** provides outstanding cushioning qualities. The elastic matting is made of PUR and rubber.

# Powershock Fitness Rubber Solutions



## High impact rubber solutions for fitness

### Powershock 80

#### Cardio & Free-weight zone

##### POWERSHOCK 80 is:

- ✓ Highly **durable**
- ✓ **Easy to clean and maintain**
- ✓ **Highly resistant** to static loads and to dumbbells thanks to the vulcanization process of this 8 mm vulcanized rubber

Vulcanized rubber is a chemical process through high pressure and temperature enables the sulfur atoms to form links and bridges between long chains of rubber molecules. This increases the overall strength and durability of the rubber.

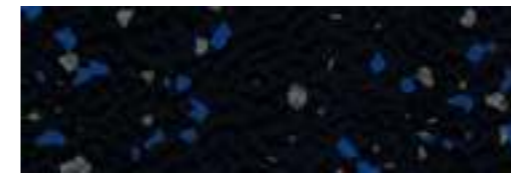

Black



8 mm  
Interlocking tiles with dovetail edges

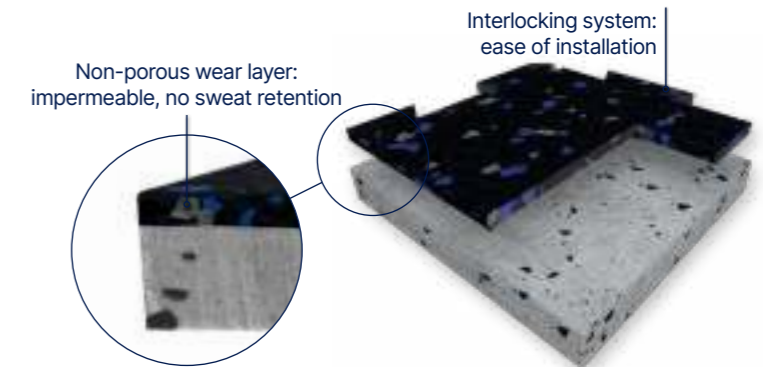

Non-porous wear layer:  
impermeable, no sweat retention

Interlocking system:  
ease of installation

#### Accessories

(available from Romus)



Aluminium reducer  
Unit : 3 lm

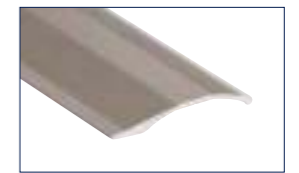

Multilevel coverstrip  
Unit : 2,7 lm

### Powershock 300

#### Crossfit & Heavy-weight area

##### POWERSHOCK 300

avoids deep-impact damage while providing an outstanding sound deadening, as well as:

- ✓ high **shock absorption**
- ✓ **Sound insulation** of 24 dB
- ✓ great **protection of the subfloor** being a 30 mm high impact rubber.



Dark Grey

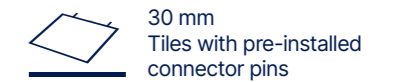

30 mm  
Tiles with pre-installed connector pins

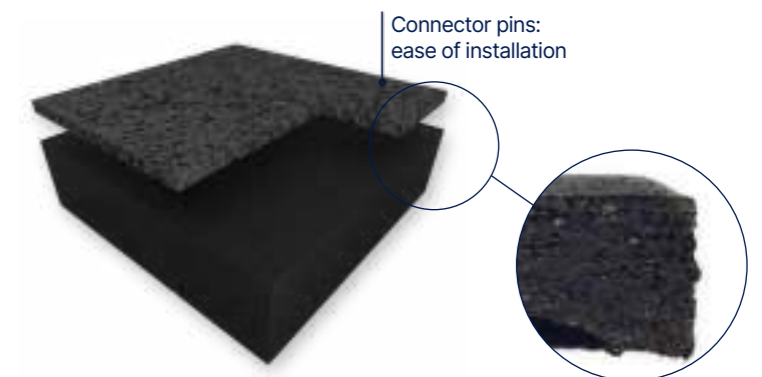

Connector pins:  
ease of installation

#### Accessories

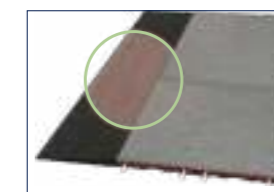

Ramp edge rubber 30 mm  
1 lm



Corner ramp edge rubber  
30 mm  
2 units (1000 x 250 mm)

# Powershock Fitness Rubber Solutions

## Technical Data

Powershock						
			300	80		
			Crossfit & heavy-weight area	Cardio & free-weight area		
Description						
Thickness	NF EN ISO 24346	mm	30 (± 2)	8		
Weight	NF EN ISO 23997	kg/tile	6,8 (±0,2)	11,9		
Size	NF EN ISO 24342	mm	500 × 500 (±0,8 %)	980 × 980 (incl. dovetails)		
Classification						
Fire resistance	EN 13501-1	class	Cfl,s1	Bfl,s1		
VOC	ISO 16000-6	class	A+	A+		
Performance						
Dimensional stability	NF EN ISO 23999	%	< 0,1	< 0,3		
Abrasion	EN ISO 5470-1	g	1,5	< 0,5		
Light resistance	EN ISO 20105 - B02	level	3	4		
Indentation resistance	EN 1516	mm	0,12	< 0,1		
Slip resistance in dry condition	EN 13036-4	unit	80-110	80-110		
Sound insulation	EN ISO 717/2	dB	24	13		
Hardness shore A	Int.	-	60	> 75		



# Our solutions for your fitness center

Each zone in your club has different constraints and requirements; we have solutions for each one of them.

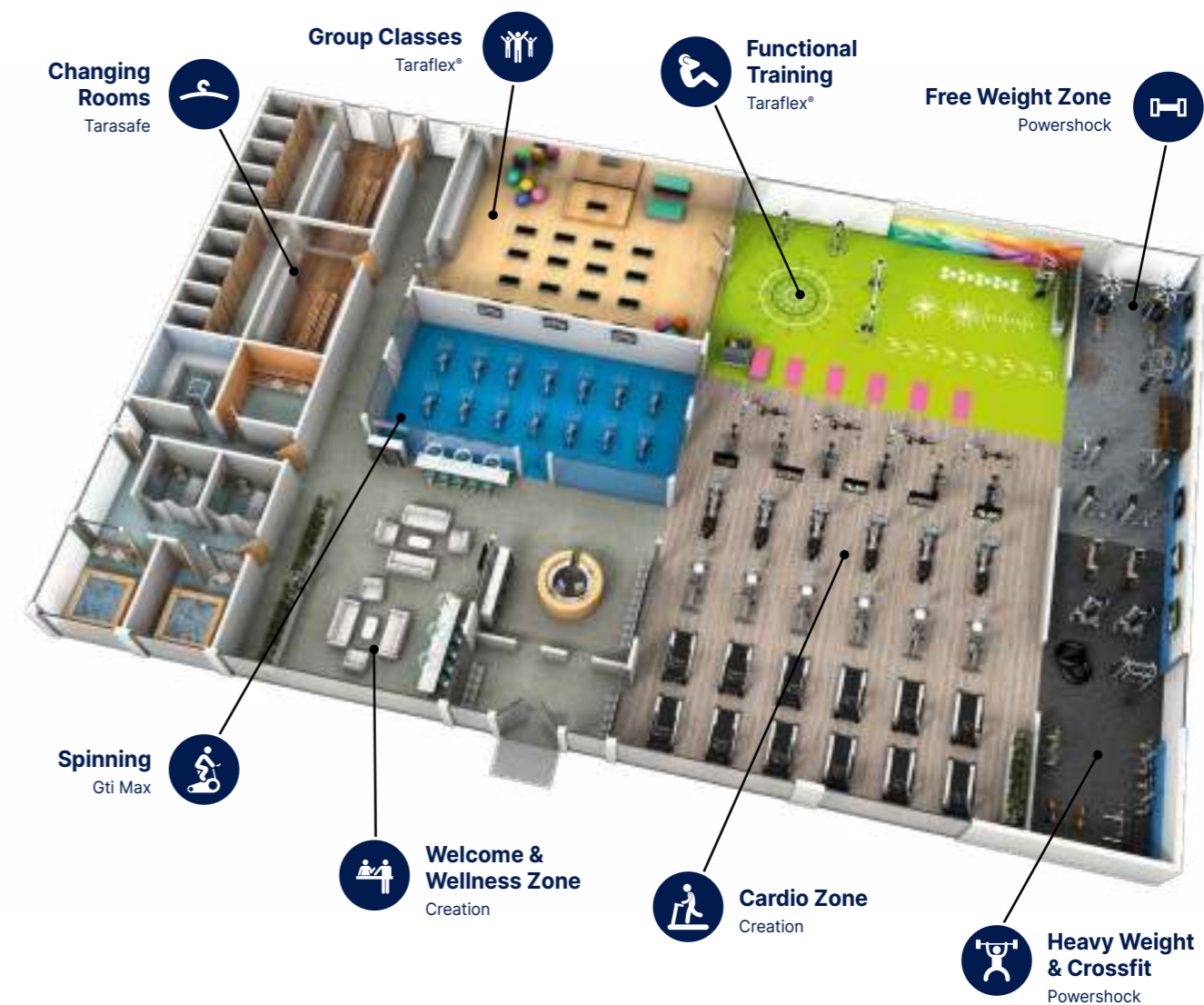

Welcome Zone



Functional Training



Spinning Zone



Cardio Zone



Group Classes



Weightlifting Zone

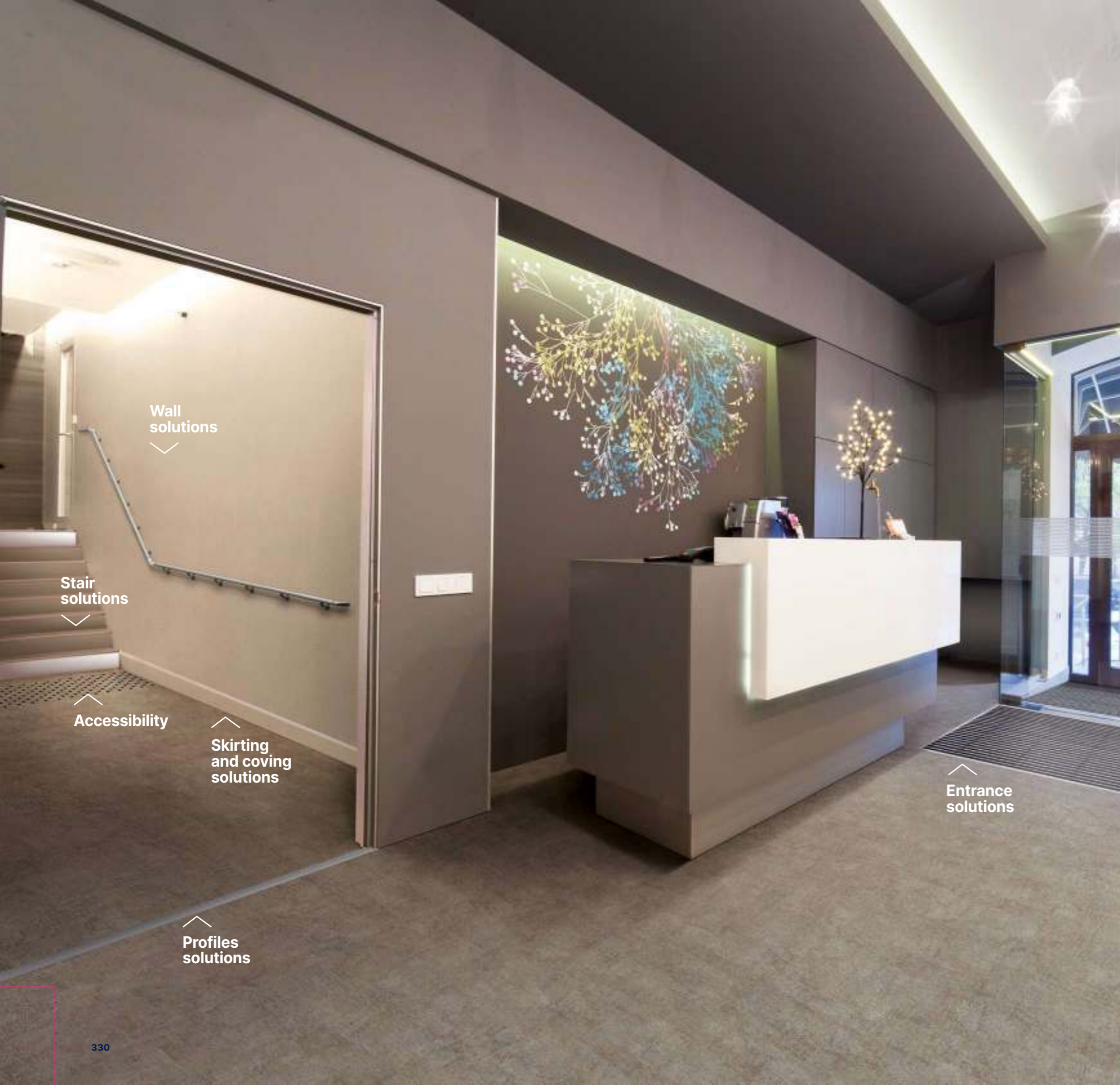

## Finishes

pages 330-363

332. Finishes

350. Technical Solutions

358. Sports Finishes

## Specifications

pages 364-371

# Finishes

## 333. Skirting and coving solutions

### 338. Stair solutions

- 338. Stair nosing inserts
- 340. Tarastep Pro / Clip System

### 344. Profile solutions

### 347. Welding solutions

### 348. Entrance solutions



# Finishes

## Skirting and coving solutions

There are two ways of finishing the junction between the floor and wall:



PVC Cove former + Capping strip



Design skirting (MDF)



Design skirting (PVC)



Flexible full cove former



Semi-rigid skirting

Making a cove.  
**This solution makes it easier to clean inside angles and edges.**  
**It gives a waterproof connection wall/floor covering.**

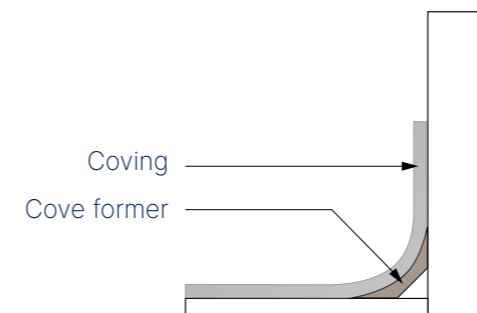

Installing the PVC covering up to the edge of the wall and using a skirting insert.  
**This is cost effective and time saving.**

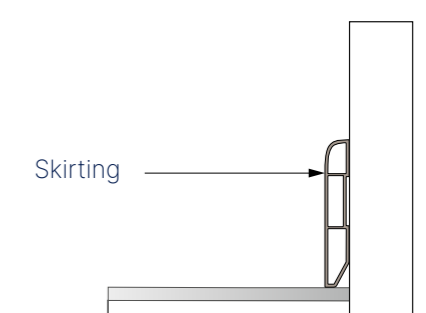

### FOCUS











Gerflor provides a complete range of solutions including skirting, stairs, profiles and welds.

# Finishes

## Coving solutions

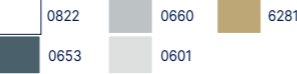
### PVC CAPPING STRIPS

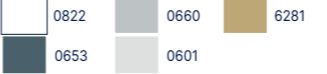
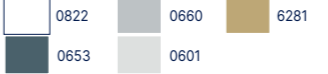

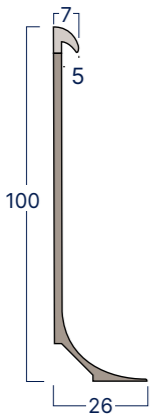
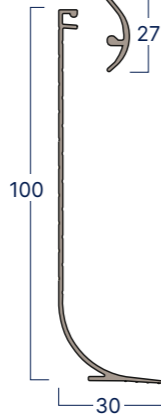
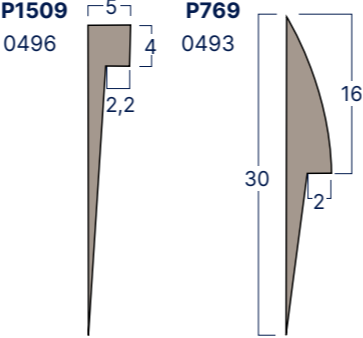
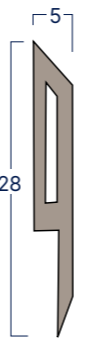
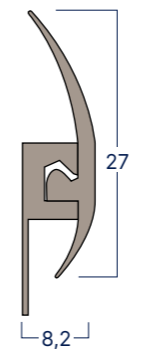
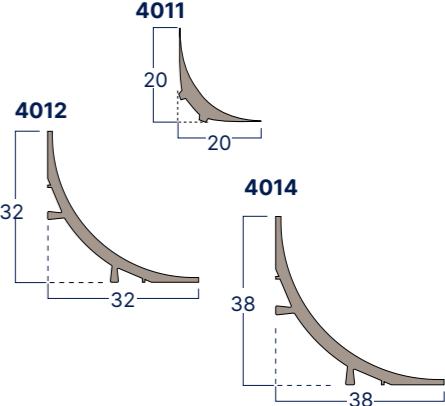

### PVC CAPPING STRIPS

Description	 <p><b>0488</b></p> <p><b>FLEXIBLE FULL COVE FORMER</b></p> <p>PVC profile combining the cover former and the capping strip into a single product.)</p> <ul style="list-style-type: none"> <li>Adapted to the hospital sector and any room requiring a waterproof skirting</li> </ul>	 <p><b>0487</b></p> <p><b>FULL COVE FORMER CLIP-SYSTEM</b></p> <p>PVC profile combining the cover former and the capping strip into a single product.</p> <ul style="list-style-type: none"> <li>Adapted to the hospital sector and any room requiring a waterproof skirting.</li> </ul>	 <p><b>0496 0493</b></p> <p><b>P1509 / P769</b></p> <p>Finishes that can be welded to the floor covering.</p> <ul style="list-style-type: none"> <li>Do not use in commercial kitchens and showers</li> </ul>	 <p><b>0491</b></p> <p><b>CAPPING STRIPS</b></p> <p>Rigid capping strip with flexible lip</p> <ul style="list-style-type: none"> <li>Do not use in commercial kitchens and showers</li> </ul>	 <p><b>0486</b></p> <p><b>CAPPING STRIP CLIP SYSTEM</b></p> <p>Rigid clipped finishing profile with 2 flexible lips</p> <ul style="list-style-type: none"> <li>Capping strip that covers the skirting</li> </ul>	 <p><b>4011 - 4012 - 4014</b></p> <p><b>PVC COVE FORMER</b></p> <p>This accessory allows the floor-wall cove to be formed</p>
Colours						
Benefits	<ul style="list-style-type: none"> <li>Maximum floor covering thickness <b>4 mm</b></li> <li>Guarantees <b>watertightness</b></li> <li><b>Quick to install</b></li> </ul>  <p><b>Packaging</b> 15 × 3 lm strips</p>	<ul style="list-style-type: none"> <li>Maximum floor covering thickness <b>4 mm</b></li> <li>Guarantees <b>watertightness</b></li> <li><b>Quick &amp; easy to install thanks to the capping strips with clip</b></li> </ul>  <p><b>Packaging</b> 20 × 3 lm strips</p>	<ul style="list-style-type: none"> <li>P769: Adapted to 2 mm floors</li> <li>P1509: Adapted to 2.2 mm floors</li> </ul>  <p><b>Packaging</b> 30 × 3 lm strips</p> <p><b>Packaging</b> 2 rolls of 25 lm</p>	<ul style="list-style-type: none"> <li>Maximum covering thickness: 4 mm</li> <li><b>Hygienic</b></li> <li><b>Easy to install</b></li> </ul>  <p><b>Packaging</b> 15 × 3 lm strips</p>	<ul style="list-style-type: none"> <li>Maximum floor covering thickness: 4 mm</li> <li>Good watertightseal for finishing floor-wall coves and floor-wall systems notably in industrial kitchens</li> <li><b>Easy to install</b> thanks to the clip system</li> </ul>  <p><b>Packaging</b> 20 × 3 lm strips</p>	<ul style="list-style-type: none"> <li>Its rounded shape <b>makes it easier to clean</b> the floor-wall junction • Propose une meilleure esthétique</li> <li>Gives a better look</li> <li>Limits the risk of piercing the floor covering</li> <li><b>Prevents accumulation</b> of dirt and bacteria</li> </ul>  <p><b>Packaging</b> 30 × 2 lm strips</p>
Tips	<ul style="list-style-type: none"> <li>Heat the skirting with a heat gun in order to match the shape of the wall</li> <li>Use either a double bonding adhesive, a dispersion contact adhesive or a double sided tape compatible with the PVC skirting</li> </ul>	<ul style="list-style-type: none"> <li>Heat the skirting with a heat gun in order to match the shape of the wall</li> <li>Use either a double bonding adhesive, a dispersion contact adhesive or a double sided tape compatible with the PVC skirting</li> </ul>	<ul style="list-style-type: none"> <li>May also be used as a floor stopping profile</li> <li>Weld with SG916</li> <li>Use either a double bonding adhesive, a dispersion contact adhesive or a two-side adhesive compatible with the PVC skirting</li> </ul>	<ul style="list-style-type: none"> <li>Slightly heat the strip if it whitens once installed</li> <li>Use a miter shear for a perfect cut</li> <li>Use either a double bonding adhesive, a dispersion contact adhesive or a double sided tape compatible with the PVC skirting</li> </ul>	<ul style="list-style-type: none"> <li>Heat the profile with a heat gun (temperature about 150°C) for the installation of the external corners</li> <li>Use a miter shear for a perfect cut</li> <li>Use SG916 for a perfect finish of the internal corners</li> <li>Slightly heat the profile if it whitens once installed</li> <li>Use either a double bonding adhesive, a dispersion contact adhesive or a double sided tape compatible with the PVC skirting</li> </ul>	<ul style="list-style-type: none"> <li>Use a mitre shear for a perfect cut</li> </ul>

Colours and images are not contractual.

# Finishes

## Skirtings

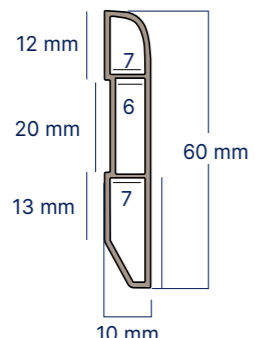
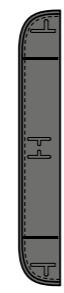
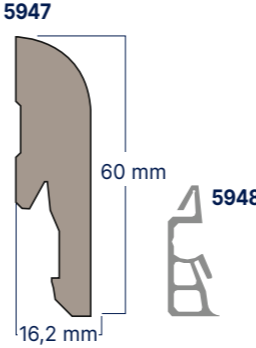
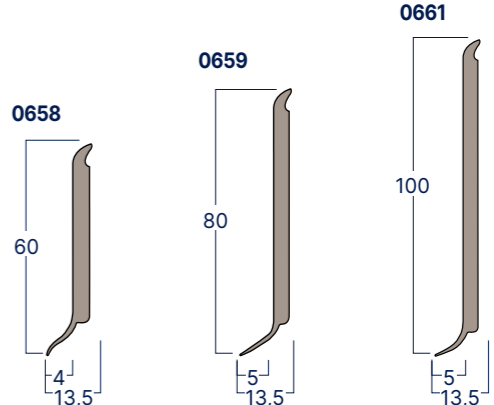
	DESIGN SKIRTING (PVC)	PVC DESIGN SKIRTING ENDCAP	DESIGN SKIRTING MDF	SEMI-RIGID SKIRTING
<b>Description</b>	 <p><b>SKIRTING (PVC)</b> Vinyl Design Skirting for a perfect finish of Gerflor floorcoverings. 100% watertight, it could be installed in all environment.</p> <p><b>6086</b></p>	 <p><b>ENDCAP (PVC)</b> These caps allow to cover PVC Design Skirting side.</p> <p><b>6087</b></p>	<div style="display: flex; justify-content: space-around;"> <div style="text-align: center;"> <p><b>GLUE DOWN</b></p>  </div> <div style="text-align: center;"> <p><b>INTERLOCKING</b></p>  </div> </div> <p><b>SKIRTING (MDF)</b> MDF Design Skirting for a perfect finish of Gerflor floorcoverings.</p> <p><b>5947</b></p>	 <p><b>VYNAFLEX</b> Semi-rigid PVC skirting to be placed on the wall</p> <p><b>60 mm: 0658 / 80 mm: 0659 / 100 mm: 0661</b></p>
<b>Colours</b>		<p>Anthracite grey 0001</p>	<p>Blanc 0822 Noir 6512 Gris 0430</p> <p>Miel 0455 Taupe 0456</p>	
<b>Benefits</b>	<ul style="list-style-type: none"> <li>Thin and discrete, it ensures an elegant finish and hides the dilatation gaps</li> <li>Available in all designs in Creation 30/40/55/70 Core Collection</li> <li>The skirting is also available in a paintable white version</li> </ul>  <p><b>Packaging</b> 6 x 2 m</p>	<ul style="list-style-type: none"> <li>PVC cap, aluminum color, fits all our PVC Design Skirtings</li> <li>Can be used for one side of the skirting or the other</li> </ul>  <p><b>Packaging</b> Bag of 10 reversible caps</p>	<ul style="list-style-type: none"> <li>Available in all designs in Creation 30/40/55/70 Core Collection</li> <li>It ensures an elegant finish and hides the dilatation gaps</li> <li>The skirting is also available in a paintable white version</li> </ul>  <p><b>Packaging</b> 5947: 5 x 2.2 m 5948: 1 box of 30 clips</p>	<ul style="list-style-type: none"> <li>Solid colour</li> <li>Resistant to washing waters</li> </ul>  <p><b>Packaging</b> 0658 / 0661: 25 format (3lm) 0659: 32 format (3lm)</p>
<b>Tips</b>	<ul style="list-style-type: none"> <li>Use a wood saw with fine teeth</li> <li>Use a mitre box for the corner</li> <li>Do not screw or nail</li> </ul>	<ul style="list-style-type: none"> <li>Cut one end, glue it, press it</li> </ul>	<ul style="list-style-type: none"> <li>Use a wood saw with fine teeth</li> <li>Use a mitre box for the corner</li> <li>For more information contact the customer service</li> </ul>	<ul style="list-style-type: none"> <li>Use skirting corner Cutter to handle internal and external angles</li> <li>Use either a double bonding adhesive, a dispersion contact adhesive or a double sided tape compatible with the PVC skirting</li> <li>Apply an adhesion primer if the sub-floor is porous</li> </ul>

Colours and images are not contractual.  
For more information contact the customer service.

# Finishes

## Stair solutions

Gerflor has developed 2 solutions for installing a Vinyl floor on stairs to complement its range of floors:

### 1 Stair nosing insert

- Install the vinyl flooring and the stair nosing by starting at the bottom of the stair
- Install the riser
- Install the stair nosing
- Install the flat of the stair
- Weld

**Adapted to straight stair nosing, rounded stair nosing and bird's beak stair nosing.**

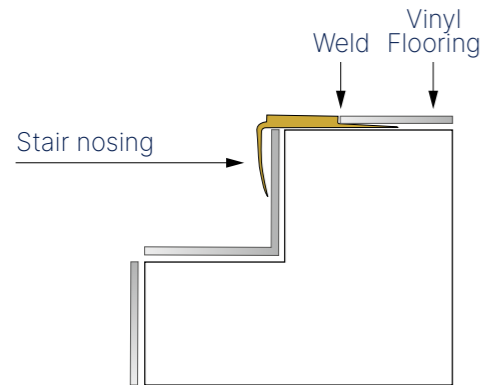

### 2 Tarastep Pro





- Install the base of the finishing clip onto the flat angle of the stair
- Install the Tarastep
- Clip the stair clip system

**Adapted to rounded stair nosing.**

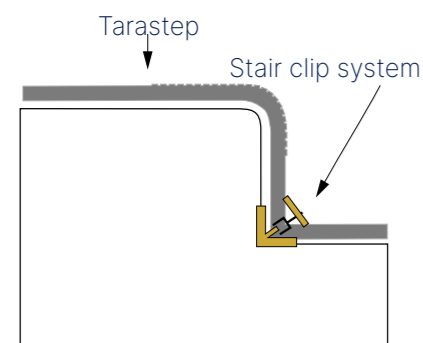
**Mill the angle for straight stair nosing.**

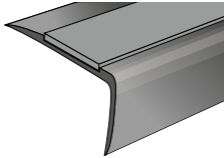
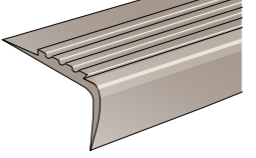
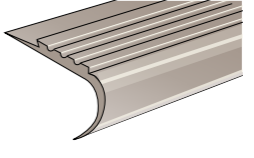
**For bird's beak stair nosing, fill the void beforehand.**

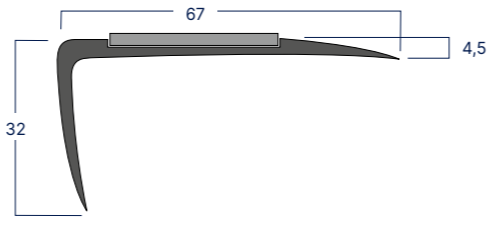
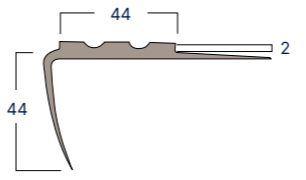
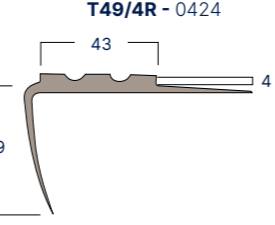
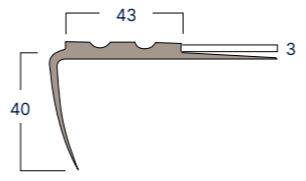
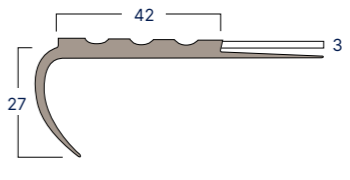

	STAIR NOSING INSERT	STAIR NOSING INSERT	STAIR NOSING INSERT
<b>Description</b>	 <p><b>ALUMINIUM STAIR NOSING</b></p> <ul style="list-style-type: none"> <li>• Landing/stair harmony</li> <li>• Guarantees floor covering durability</li> </ul> <p><b>0664</b></p>	 <p><b>GROOVED PVC STAIR NOSING</b></p> <p>T49/4R - T49/3R - T49/2R Straight angles</p> <p><b>0424 - 0462 - 0461</b></p>	 <p><b>GROOVED PVC STAIR NOSING</b></p> <p>T27/3R Rounded angles and bird's beak</p> <p><b>0467</b></p>
<b>Colours</b>	 0001		
<b>Benefits</b>	<ul style="list-style-type: none"> <li>• For a state-of-the-art stair finish</li> <li>• Delivered with a black strip made out of carborandum for an improved anti-sliping action of the stair nosing</li> </ul>  <p><b>Packaging</b> 5 × 3 lm strips + 5 carborandum strips</p>	<p>T49/4R - T49/3R - T49/2R</p> <ul style="list-style-type: none"> <li>• Adapted to 2, 3 or 4 mm floor covering</li> <li>• Weldable</li> </ul> <p><b>T49/2R - 0461</b></p>  <p><b>T49/4R - 0424</b></p>  <p><b>T49/3R - 0462</b></p>  <p><b>Packaging</b> 10 × 3 lm strips</p>	<p>T27/3R</p> <ul style="list-style-type: none"> <li>• Adapted to 3 mm floor covering</li> <li>• Weldable</li> </ul> <p><b>T27/3R - 0467</b></p>  <p><b>Packaging</b> 10 × 3 lm strips</p>
<b>Tips</b>	<ul style="list-style-type: none"> <li>• Secure with flat head cross head countersunk stainless steel screws (not included)</li> </ul>	<ul style="list-style-type: none"> <li>• Do not apply adhesive to the vertical part of the stair nosing</li> <li>• Double bonding</li> </ul>	

Colours and images are not contractual.

# Finishes

## Stair solutions / Tarastep Pro

### Tarastep Pro

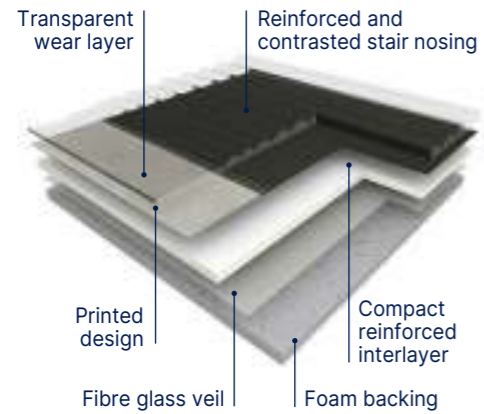

**TARASTEP PRO** is an **heterogenous, sound-absorbing** solution with reinforced layer and transparent wearlayer, used to **recover indoor stairs in a single element**. **TARASTEP PRO is an all-in-one** covering that covers the tread, the stair nosing - with a reinforced non-slip surface, and the riser. It has a total thickness of 3.45 mm, with a **wear layer of 1 mm** which gives it great resistance to traffic and a residual indentation of 0.10 mm (value measured). With a high-density foam backing, TARASTEP PRO provides 17dB of sound insulation and 63dB of walking noise. **It complies with accessibility regulations**. The stair nosing specially designed to facilitate movement presents a **tactile contrast and a visual contrast** of at least 70% on each color. **TARASTEP PRO** is suitable for premises classified **34/42 European class**. According to standard NF EN 13501-1, the coating is classified Bfls1. It is phthalate-free and complies with the European REACH regulation. TVOC air emissions at 28 days (NF EN 16000) of the selected coating are < 100 µg / m<sup>3</sup>. It is 100% recyclable.

Access for all (More details - See page 351)



- **Complete solution for stairs:** more durable
- **Concrete design with 70% minimum contrast** with stair nose
- **Mix & match with Taralay and Premium ranges:** colors harmony stair & floor
- **High thickness:** comfort underfoot
- **1 mm wearlayer:** high resistance to traffic

### Tarastep Pro

Description			
Total thickness	EN ISO 24346	mm	3.45
Thickness of wearlayer	EN ISO 24340	mm	1
Weight	EN ISO 23997	g/sqm	3005
Width of sheet	EN ISO 24341	cm	100
Length of sheet	EN ISO 24341	lm	20
Phthalate free	-	-	OK
Classification			
Norm / Product specification	-	-	EN ISO 11638
European classification	EN ISO 10874	class	34-42
Impact sound insulation	EN ISO 717-2	dB	17
Walking sound	NFS 31 074	dB	< 65
Fire rating	EN 13501-1	class	Bfl-s1
Static electrical propensity	EN 1815	kV	< 2
Slip Resistance Wet	EN 16165:2021 – Appendix B (DIN 51 130)	classe	R10
Performances			
Wear resistance	EN 660.2	mm <sup>3</sup>	≤ 2.0
Wear group	-	group	T
Dimensional stability	EN ISO 23999	%	≤ 0.40
Residual indentation (requirement)	EN ISO 24343-1	mm	≤ 0.20
Residual indentation (average measured value)	-	-	≈ 0.10
Thermal conductivity	EN ISO 10456	W/(m.k)	0.25
Colour fastness	EN ISO 105-B02	degree	≥ 6
Surface Treatment	-	-	Protecsol®
Chemical products resistance <sup>(1)</sup>	EN ISO 26987	-	OK
Environment			
Recyclability	-	%	100
EPD	-	-	Available
Health			
TVOC after 28 days	ISO 16000-6	microgram/m <sup>3</sup>	< 100
Certification	-	-	Floorscore®
Anti-bacterial activity (E. coli - S. aureus - MRSA) <sup>(2)</sup>	ISO 22196	-	> 99% inhibits growth
Anti-viral activity (human coronavirus) after 2h <sup>(2)</sup>	ISO 21702	-	> 99.3% virucidal activity
CE marking			
CE		EN 14041	

(1) Regarding the resistance to chemicals, please download the corresponding leaflet from our website.  
 (2) The implementation of an effective cleaning regime is the most important defence against infection.

# Finishes

## Stair solutions / Tarastep Pro

Acoustic 17 dB  100% recyclable

**CUTTING SERVICE AVAILABLE**

**CUTTING SERVICE AVAILABLE**



2338 Sand & Brown  
**82% contrast**

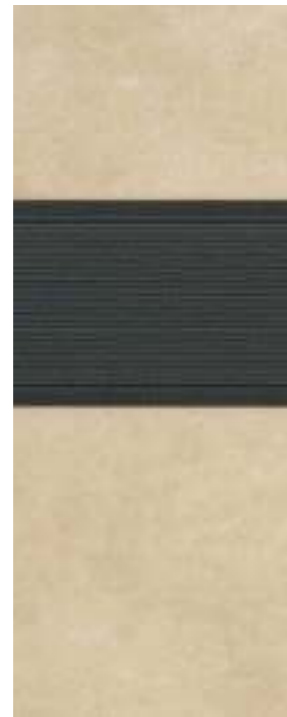

2333 Nature & Dark Grey  
**83% contrast**



2335 Capri & Black  
**79% contrast**

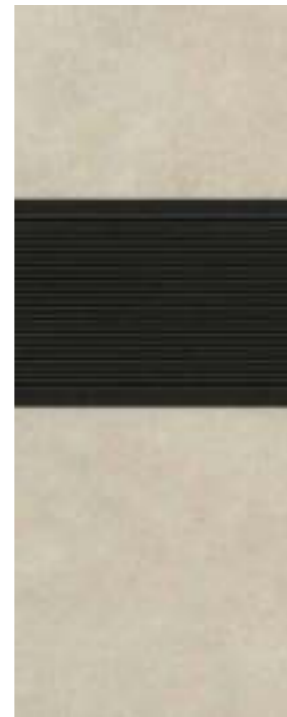

2342 Genova & Dark Grey  
**90% contrast**



2336 Brescia & Black  
**84% contrast**



2343 Light Grey & Black  
**85% contrast**



2341 Black & Light Grey  
**77% contrast**



2332 Silver & Dark Grey  
**86% contrast**



2339 Dark Grey & Yellow  
**73% contrast**

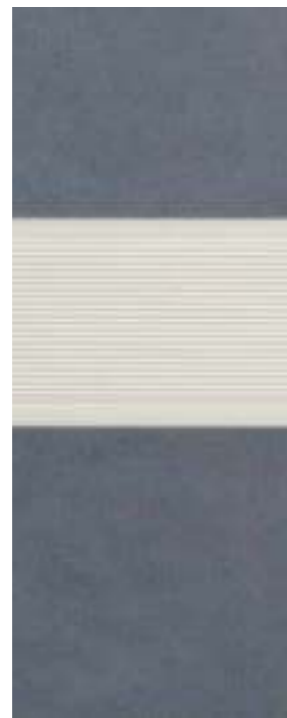

2334 Blue Grey & Clear  
**73% contrast**



2337 Deep Blue & Clear  
**77% contrast**



2344 Silver & Green  
**73% contrast**



2340 Warm Grey & Black  
**77% contrast**

# Finishes

## Profile solutions

Our profiles provide solutions to several problems concerning links between floors, walls or bare spots depending on the flooring thickness and technical requirements.



Diminishing profile



Connection profile



Design coverstrip



Ramp edges



Aluminium profiles

They in particular, allow two types of connections to be dealt with:

### 1 Connecting profiles

The connections between two floor coverings

- Floor/Floor
- Floor/wall

**Allow the link between two floor coverings with different thicknesses.**

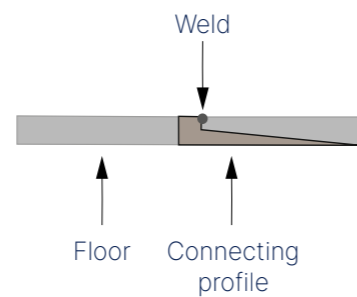

### 2 Ramp edges

The vinyl floor/bare spot connections

**Protect the edging and prevent the floor covering from delaminating.**

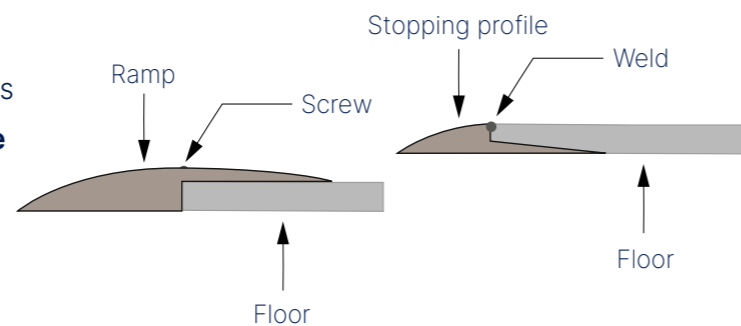

## PVC profiles











	FLOOR TO WALL CONNECTING PROFILE	FLOOR TO FLOOR CONNECTING PROFILE	DESIGN COVERSTRIP
Description	 <p><b>0490</b></p> <p><b>DIMINISHING PROFILE</b></p> <ul style="list-style-type: none"> <li>• Coving/wall covering connection</li> <li>• Used in laboratories, hospital shower systems, commercial kitchens</li> </ul>	 <p><b>0496</b></p> <p><b>P1509</b></p> <ul style="list-style-type: none"> <li>• These products allow the link between two-floor coverings to be made</li> </ul>	 <p><b>0642 + Color code</b></p> <ul style="list-style-type: none"> <li>• Aluminium coverstrip with digital printed foil matching with some Gerflor LVT ranges</li> </ul>
Colours	 <p>Noir 6512</p>	 <p>Noir 6512 Gris 4203</p>	<p>17 designs matching with Creation and Virtuo ranges + 1 Alu color.</p>
Benefits	<ul style="list-style-type: none"> <li>• Makes it easier to link the floor covering and wall</li> <li>• <b>Hygienic.</b> Avoids bacteria accumulation</li> <li>• <b>Prevents the</b> floor covering from <b>tearing</b>, improves <b>durability</b> and ensures <b>watertightness</b></li> </ul> 	<ul style="list-style-type: none"> <li>• Junction between two floors of 2.2 mm and 5 mm</li> <li>• Floor covering can be welded to profile to create a watertight seal</li> <li>• <b>Can also be used as a finishing profile</b></li> </ul> 	<ul style="list-style-type: none"> <li>• 1 profile, 4 usages</li> </ul>  <p>1. Expansion gap</p>  <p>2. Ramp</p>  <p>3. Threshold</p>  <p>4. Junction</p>
Tips	<p><b>Packaging</b> 2 rolls of 25 lm</p> <ul style="list-style-type: none"> <li>• Bonding with acrylic adhesive</li> </ul>	<p><b>Packaging</b> 30 x 3 lm strips</p> <ul style="list-style-type: none"> <li>• Polychloroprene double bonding</li> </ul>	<p><b>Packaging</b> 4 units / box - 37 mm x 930 mn</p>

Colours and images are not contractual.

# Finishes

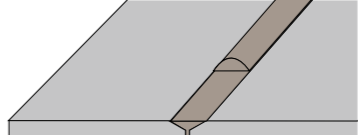
## Ramp Edges

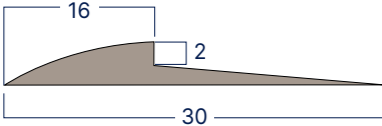
## Ramp Edges/ Welding solutions

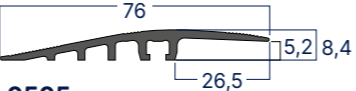
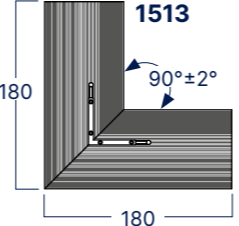
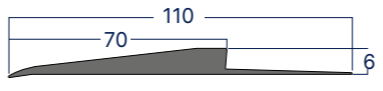
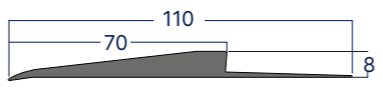
	RAMP EDGES	SCREWED	LOOSELAY	HOT WELD	
Description	 <p>P769</p> <ul style="list-style-type: none"> <li>Connect other surfaces and vinyl floors</li> </ul> <p><b>0493</b></p>	 <p>ALUMINIUM RAMP 2.8 MM</p> <ul style="list-style-type: none"> <li>Access ramps resistant to high traffic and humidity</li> </ul> <p><b>0504</b></p>	 <p>ALUMINIUM RAMP 5-6 MM</p> <p><b>0505</b></p>  <p>ALUMINIUM CORNER 5-6 MM</p> <p><b>1513</b></p> <p>Access ramps resistant to high traffic and humidity</p>	 <p>PVC RAMP 6 MM</p> <p><b>0500</b></p> <p>PVC RAMP 8 MM <b>New</b></p> <p><b>7032</b></p>	 <p>WELDING RODS</p> <ul style="list-style-type: none"> <li>This is used for all types of PVC floors, for coving sport floors</li> <li>Ensures a complete watertight seal</li> </ul> <p><b>Gerflor has a large range of rods available</b></p> <p>Ø 4 mm / Ø 4.1 mm / Ø 5 mm / Ø 6 mm</p>  <p>The welding rod is placed in the chamfer between two floor coverings. When heated, it melts and fills the entire space to ensure complete watertight seal.</p>
Colours	<ul style="list-style-type: none"> <li>Noir 6512</li> <li>Gris 4203</li> </ul>	0001	0001	0001	<p>WELDING ROD AND FLOORING MATCHING TOOL</p> <p><a href="http://gerflor.com/servicesprofessionals/welding-rods-matching.html">gerflor.com/servicesprofessionals/welding-rods-matching.html</a></p> 
Benefits	<ul style="list-style-type: none"> <li>Floor covering <b>welding</b> system</li> <li>Suitable for 2 mm floors</li> <li>Ensures watertight seal</li> <li>Can also be used as a capping strip</li> </ul>  <p><b>Packaging</b> 2 rolls de 25 lm</p>	<p>Product suitable for floor coverings of:</p> <ul style="list-style-type: none"> <li>2-3 mm</li> </ul> <p>(<b>Creation 70, Creation 55, Creation 30, ...</b>)</p>  <p><b>0504</b></p> <p><b>Packaging</b> 10 × 3 lm ramps</p>	<ul style="list-style-type: none"> <li>Smooth shape for more utilisation comfort</li> <li>Connectors for a perfect connection of 2 profiles</li> <li>Pre-assembled corners for an easier installation and a perfect finish</li> </ul> <p>Products suitable for floor coverings of:</p> <ul style="list-style-type: none"> <li>5-6 mm (<b>Attraction®, GTI® MAX, Creation 70 Clic, Creation 55 Solid Clic, Creation 30 Solid Clic, ...</b>)</li> </ul>  <p><b>0505</b></p>  <p><b>1513</b></p> <p><b>Packaging</b> 5 × 3 lm ramps (0505) / 4 corners (1513)</p>	<ul style="list-style-type: none"> <li>Product suitable for floor coverings of 6/8 mm (GTI®)</li> <li>Easy to install &amp; no floor damage: time saving</li> <li>Unbreakable &amp; less scratches: fewer replacing costs</li> <li>Easy to cut</li> </ul>  <p><b>0500</b></p>  <p><b>7032</b></p> <p><b>Packaging</b> 8 lengths x 2 lm / box</p>	<p>Product suitable for floor coverings of:</p> <ul style="list-style-type: none"> <li><b>CR40:</b> Floor/floor weld - Code 0585</li> <li><b>CR50:</b> Welding of sport floors - Code H209</li> </ul> <p><b>Specific weld rods</b></p> <ul style="list-style-type: none"> <li><b>CR50:</b> Weld, Tarasafe Plus, floor repairs on special order - Code H009</li> <li><b>CA72:</b> Triangular rod for commercial kitchen floor to base welding - Code H007</li> <li><b>CR60:</b> Welding of sport floors, repair on special order - Code H011</li> <li><b>BBR40:</b> 100% Bio-based plasticizer rod for Mipolam Symbioz</li> <li><b>MCR40:</b> Multicolor rod for Mipolam Accord &amp; Affinity - Code H058</li> <li><b>ULR40:</b> Plain color welding rods for Linoleum floorcoverings (Colorette, Uni Walton, Lino Art) - R897</li> <li><b>MLR40:</b> Marble color welding rods for Linoleum floorcorings (Marmorette, Linodur): invisible seals - R898</li> </ul> <p><b>Packaging</b> CR40, BBR40, CR50, CA72: 100 lm. coil CR60: 60 lm. coil MCR40: 50 lm. coil</p> <p><i>Please contact us for further information on weld rods</i></p>
Tips	<ul style="list-style-type: none"> <li>Double bonding</li> </ul>	<ul style="list-style-type: none"> <li>Delivered with fixation kit</li> <li>Screwing of the ramp to the floor with flat cross head countersunk stainless steel screws (Aluminium ramp 5-6 mm and aluminium corner)</li> </ul>	<ul style="list-style-type: none"> <li>Looselay installation without damaging the subfloor (looselay ramp)</li> </ul>	<ul style="list-style-type: none"> <li>For a better weld the correct grooving should be performed.</li> <li>Use an adapted nozzle (Ultra Speed Nozzle).</li> </ul>	

Colours and images are not contractual.

# Finishes

## Entrance Solutions

Three cleaning zones to be covered at the entrance to a building

Each zone has a specific "cleaning" role:



### Zone 1



Ribbed Rubber Insert

**Romat**  
Frequent traffic (500 p/day)

**Romat GT**  
Heavy traffic (500 to 2,000 p/day)

**Reversible**  
Intensive traffic (> 2,000 p/day)

### Zone 2

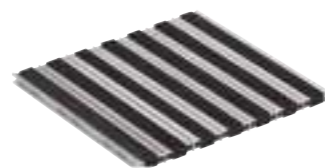

Textile Insert

**Romat**  
Frequent traffic (500 p/day)

**Romat GT**  
Heavy traffic (500 to 2,000 p/day)

Rubber Grate Insert

**Romat reverse**  
Intensive traffic (> 2,000 p/day)

### Zone 3



Dirt-Trapping Mat

**Ronet**  
Frequent traffic (500 p/day)

**Roclean**  
Heavy traffic (> 500 p/day)

## Entrance Mats

- ▶ Eliminate dust, moisture and other residue from visitors' feet as efficiently as possible at the entrance of a building.
- ▶ Prevent premature soiling and wear of floor coverings.

### LOOSELAY ROMAT GT - INSERT KIT



Ref. 1719 - 1.5 × 1 m

#### For pedestrian traffic only.

Entrance mat affording floors of buildings efficient and sustainable protection from pedestrian traffic by forming a barrier to outside dirt. Thanks to its loose-lay installation, the mat can be installed without damaging the surface. Adapted for an important pedestrian traffic (up to 2000 people per day).

#### This kit contains:

- ▶ 1 mat
- ▶ 4 frames composed of 4 lower and 4 upper profiles
- ▶ 4 external pre-assembled corners
- ▶ 60 5-7 screws
- ▶ 1 Installation guideline

### KIT ESPLANADE 9000



Ref. 1700 - 1.5 × 1.5 m

Kit for the incrustation of an ESPLANADE 9000 mat in an area covered with Attraction®, GTI®, Creation 55 Solid Clic, Creation 70 Clic. The closed conception of the mat enable to scratch the underside of shoes and increase the durability of the floors. It resists to intense pedestrian traffic (up to 5000/day) and to mecanial traffic.

- ▶ Packaging: 2.5 sqm kit: 3 mats modules, 4 upper and 4 lower profiles, screws.

# Technical Solutions

## 351. Accessibility

## 352. LVT Underlayers

## 354. Specific products

- 354. Isolating membranes
- 354. ESD copper strip
- 355. Clean Corner System

## 356. Adhesives and tapes



### FOCUS

Gerflor offers a full range of technical solutions such as the shower system, copper strips, adhesives or tools in order to provide all the technical requirements on site.

# Technical Solutions

## Accessibility



### WARNING SURFACES

ALERTILE, SELF-ADHESIVE OR WELDABLE TACTILE SLAB

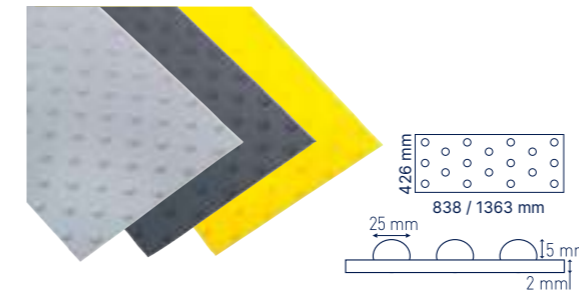

Dimensions: 426 × 1363 mm / 426 × 838 mm  
 Packaging: 8 units per box (838 mm)  
 4 units per box (1363 mm)  
 Codes: 059B (838 mm) / 059A (1363 mm)

EASYPLOT, THE AESTHETIC SOLUTION FOR WARNING



Packaging: Kit of 198 studs (6 planks de 33 studs)  
 approx. 1.3 m x 0.4 m  
 Codes: 059C (Grey, Black) - 059D (Alu)



### GUIDING

EASYGUIDE, THE SELF-ADHESIVE SOLUTION FOR GUIDING



Packaging: Box of 6 slabs 300 × 220 mm (4 bars/slab) for 1.8 m of guideline  
 Code E219



### SIGNAGE

Personalised cut-to-size system



# Technical Solutions

## LVT Underlayers

	CREATION 40/55/70 CLIC	CREATION 40/55 CLIC	CREATION 40/55/70 CLIC	CREATION 30/40/55
Description	<p>GERFLOR ACOUSTIC 15 DB</p>  <p><b>1798</b></p> <ul style="list-style-type: none"> <li>Sound absorption underlay in roll</li> </ul>	<p>GERFLOR SILENCE PLUS 19 DB</p>  <p><b>5949</b></p> <ul style="list-style-type: none"> <li>Sound absorption underlay in accordion</li> </ul>	<p>GERFLOR ACOUSTIC PLUS 19 DB</p>  <p><b>0704</b></p> <ul style="list-style-type: none"> <li>Sound absorption underlay in roll</li> </ul>	<p>GERFLOR SMART FIX 16 DB</p>  <p><b>1698</b></p> <ul style="list-style-type: none"> <li>Underlay with self-adhesive surface</li> <li>Sound absorption underlay in roll</li> </ul>
Benefits	<ul style="list-style-type: none"> <li>Reduces impact noise up to <b>15 dB</b></li> <li>Adapted to the same traffic than the LVT but semi-industrial or industrial application</li> <li>Thickness: <b>0.93 mm</b></li> </ul> <p><b>Packaging</b> 1798 - 1 × 15 lm = 15 sqm</p>	<ul style="list-style-type: none"> <li>Reduces impact noise up to <b>19 dB</b></li> <li>Adapted to the same traffic than the LVT but semi-industrial or industrial application</li> <li>Thickness: <b>1.5 mm</b></li> </ul> <p><b>Packaging</b> 5949 - 1.18 × 8.5 lm = 10 sqm</p>	<ul style="list-style-type: none"> <li>Reduces impact noise up to <b>19 dB</b></li> <li>Adapted to the same traffic than the LVT but semi-industrial or industrial application</li> <li>Thickness: <b>1.2 mm</b></li> </ul> <p><b>Packaging</b> 704 - 0,98 × 15,3 lm = 15 sqm</p>	<ul style="list-style-type: none"> <li>For a loose lay installation of LVT dry back.</li> <li>Reduces impact noise up to <b>16 dB</b></li> <li>Adapted to the same traffic than the LVT but semi-industrial or industrial application</li> <li>Thickness: <b>2 mm</b></li> </ul> <p><b>Packaging</b> 1 × 7.5 lm = 7.5 sqm</p>
Tips	<ul style="list-style-type: none"> <li>Underlay is rolled on reverse</li> <li>Refer to technical installation guidelines to check the approved products</li> </ul>	<ul style="list-style-type: none"> <li>Printed side on top</li> <li>Refer to technical installation guidelines to check the approved products</li> </ul>	<ul style="list-style-type: none"> <li>Unroll the underlay</li> <li>Refer to technical installation guidelines to check the approved products</li> </ul>	<ul style="list-style-type: none"> <li>Fleece side: on the subfloor</li> <li>Adhesived side: under the LVT</li> <li>Refer to technical installation guidelines to check the approved products</li> </ul>

	ISOLATING MEMBRANES	ELECTRICAL CONDUCTIVITY	INTERNAL CORNER	EXTERNAL CORNER	TEMPLATES KIT			
Description	<p>ISOLSPORT</p>  <p><b>0829 0002</b> VINYL ISOLATING MEMBRANE <b>Specially designed for sports</b> For installation on concrete subfloors</p>	<p>TARAFOAM</p>  <p><b>997C 6792</b> COMFORT VERSION OF THE SHOWER SYSTEM</p>	<p>COPPER STRIP</p>  <p><b>0586 0001</b> ESD COPPER STRIP Copper strip enabling earthing</p>	 <p><b>058S</b> PROFILE FOR INTERNAL CORNERS</p>	 <p><b>058R</b> PROFILE FOR EXTERNAL CORNERS</p>	 <p>Internal corner</p>  <p>External corner</p> <p><b>058T</b> Kit made of 2 templates for an easy and homogeneous installation of the internal and external corners</p>		
Benefits	<ul style="list-style-type: none"> <li>Vinyl isolating membrane, double side on non woven glass fibre with backing design made up of 3-branch star foam pads.</li> <li>Its design enables loose laying on sensitive subfloors (risks of humidity, coated, etc.) when it is associated with a Taraflex® sporting floor. The raised effect allows humidity to circulate.</li> <li>Thickness: 1.7 mm</li> </ul>	<ul style="list-style-type: none"> <li>Provides <b>acoustic insulation for the shower system</b> (15 dB) and comfort under foot.</li> <li>Thickness: 2 mm</li> </ul>	<ul style="list-style-type: none"> <li>For electro-conductive floor coverings such as Elegance EL5, Technic EL5, GTI® EL5, Affinity EL7, Robust EL7</li> <li>Width 10 mm, thickness 0.08 mm</li> </ul>	 <p>Watertight</p>	 <p>Resistant &amp; Durable</p>	 <p>Clean</p>	 <p>Versatile</p>	 <p>Attractive</p>
Packaging	1 × 45 lm roll	Roll of 2 m x 20 lm - 40 m <sup>2</sup>	1 × 200 lm roll	60 / box	20 / box	Unit		
Tips	<ul style="list-style-type: none"> <li>Bond well at doors with PU adhesive to prevent delamination.</li> <li>Keep the raised surface, floor side, on the periphery</li> <li>Edge to edge installation</li> </ul>	<ul style="list-style-type: none"> <li>Levels out around the edge of the room</li> <li>Acrylic bonding</li> <li>Edge to edge installation</li> </ul>	<ul style="list-style-type: none"> <li>Prevent discontinuity between the angles by folding it back onto itself</li> </ul>					

Colours and images are not contractual.

Installation guidelines on [gerflor.com](http://gerflor.com)

# Technical Solutions

## Adhesives and Tapes

Gerflor has developed specific bonding solutions to make it easier to install its products.

	ADHESIVES	hop HOLDING TAPE <b>New</b>	NON-MIGRATING DOUBLE SIDED TAPES	
Description	<p>GERPUR</p>  <p><b>086C 0083</b> Specially designed for sports Only for Dry Tex™ System (bonding of Taraflex sport floors with non-woven backing)</p>	<p>hop HOLDING TAPE</p>  <p><b>059E0001</b></p>	<p>FIX&amp;FREE 100</p>  <p><b>058U 0001</b></p>	<p>FIX&amp;FREE 740</p>  <p><b>058W 0001</b></p>
		Width: 96 mm	Width: 100 mm	Width: 740 mm
Benefits	<ul style="list-style-type: none"> <li>• Bonding on new and old humid concrete subfloor</li> <li>• Mono component PU adhesive, reactive to humidity which enables the DTX material to be fully bonded in humid environment (no restriction of humidity levels with the exception of surface water)</li> <li>• Consumption: 400 to 450 g/m<sup>2</sup></li> </ul> <p><b>Packaging</b> 15 kg bucket</p>	<ul style="list-style-type: none"> <li>• Reinforced tape: durable</li> <li>• Easy to position</li> <li>• No transfer to surface underneath</li> <li>• Easy to remove without damaging the support</li> <li>• Makes welding easier</li> </ul> <p><b>Packaging</b> 1 × 50 lm roll</p>	<ul style="list-style-type: none"> <li>• New double-sided tapes in order to install and uninstall our floorcovering easily, without damaging the subfloor. This is particularly useful for "ephemeral areas" (in retail for instance) or for renovation of subfloor containing asbestos.</li> <li>• Fix&amp;Free 100 is suitable for textile backing floorcovering.</li> <li>• Fix&amp;Free 740 is suitable for Creation Clic and GTI®.</li> <li>• Time saving and cleanliness by comparison with a bonded system.</li> <li>• No gumming time and no smell.</li> </ul> <p><b>Packaging</b> 1 × 50 lm roll</p>	<p><b>Packaging</b> 1 × 25 lm roll</p>
Tips	<ul style="list-style-type: none"> <li>• To be applied with ergonomic trowel for rigid adhesive and B1 blade</li> </ul>			

Colours and images are not contractual.

# Sports Finishes

- 359. Marking
- 360. Specific Products
- 362. Adhesives and Tapes
- 363. Tools - Sport



## FOCUS

We provide finishing solutions suitable for sports floor coverings such as permanent or temporary line marking solutions.

# Sports Finishes

## Marking



### PERMANENT GAME LINES (PAINT)

Description	Article code	Components
KIT TLD AQUA BASKET	085V0001	4 red paint's can, 4 hardener's can, 9 adhesive tapes and 1 roller
KIT TLD AQUA BADMINTON	085W0001	3 black paint's can, 3 hardener's can, 7 adhesive tapes and 1 roller
KIT TLD AQUA TENNIS	085X0001	3 white paint's can, 3 hardener's can, 7 adhesive tapes and 1 roller
KIT TLD AQUA HANDBALL	085Y0001	4 yellow paint's can, 4 hardener's can, 9 adhesive tapes and 1 roller
KIT TLD AQUA VOLLEY	085Z0001	2 blue paint's can, 2 hardener's can, 3 adhesive tapes and 1 roller

### TEMPORARY GAME LINES (TAPE)

Description	Article code	Use
3M TAPES BLACK (**)	HQ250002	For game lines
3M TAPES WHITE (**)	HQ250004(*)	For game lines - White = Tennis
3M TAPES RED (**)	HQ250005	For game lines - Red = Basket
3M TAPES BLUE (**)	HQ250006	For game lines - Blue = Volley



### GAME LINE EQUIPMENT (PERMANENT & TEMPORARY)

Description	Article code	Use
GAME LINE MARKING DEVICE	087W0001	Circular line marking of up 9 m radius can be achieved with this device.
GAME LINE MARKING DEVICE AND CIRCLE CUTTER	087X0001	<p><b>COMPONENTS</b></p> <ul style="list-style-type: none"> <li>① Marking head with 50 mm adhesive marking tape</li> <li>② Marking head with 19 mm protective tape</li> <li>③ Extension poles</li> <li>④ Pole-connections</li> <li>⑤ Centre-part with 2 suction cups</li> <li>⑥ Sheet metal guides for straight lines</li> <li>⑦ Transporting case ABS</li> <li>⑧ Case for extension poles</li> </ul> <p>Circle cutter (optional for only 087X0001)</p>

(\*) White color can be used for any other monosport court.  
 (\*\*) To be installed on Taraflex® Range except on portable embossing.



Game Line Marking Device



Circle Cutter

# Sports Finishes

Specific Products / Isolating membrane & cleaning detergents

Specific Products / Cleaning detergents

	BATECO	SPORT FLOOR MAINTENANCE	SPORT FLOOR MAINTENANCE	PROTECSOL® FLOOR MAINTENANCE
<b>Description</b>	 <p><b>H3756801 (customized lengths)</b>  <b>HM126801 (standard lengths at 20 lm)</b>  <b>HM066801 (standard lengths at 30 lm)</b></p> <p>PROTECTIVE SURFACE</p> <p><b>Specially designed for sports</b>            Suitable for gymnasium / reception hall versatility</p>	 <p><b>089C0001</b>            TRACIFLEX</p> <ul style="list-style-type: none"> <li>• Multipurpose detergent for cleaning the vinyl sport floors (shoe marks and contact marks)</li> <li>• Also suitable for floors which are difficult to clean</li> <li>• For daily or weekly maintenance</li> </ul>	 <p><b>085E 0001</b>            TANEX TROPHY</p> <ul style="list-style-type: none"> <li>• Multipurpose detergent for cleaning the vinyl sport floors (shoe marks and contact marks)</li> <li>• Also suitable for floors which are difficult to clean</li> <li>• For weekly maintenance</li> </ul>	 <p><b>085A 0010</b>            SPRAY TARACLEAN</p> <ul style="list-style-type: none"> <li>• Spray cleaner to remove occasional and tough stains, notably resin marks</li> </ul>
<b>Benefits</b>	<ul style="list-style-type: none"> <li>• <b>Protective surface</b> made from black calendered and grained plasticised vinyl.</li> <li>• Taraflex Bateco is especially designed to protect sport floors in the event of non-sports use of the room. It prevents marking by chairs, tables, heels on the sport floor.</li> <li>• Thickness: 1.5 mm</li> </ul> <p><b>Packaging</b>            1 roll (12 to 45 lm)</p>	<ul style="list-style-type: none"> <li>• Removes resin from Handball courts</li> <li>• Recommended in sport room</li> </ul>  <p><b>Packaging</b>            5 L can</p>	<ul style="list-style-type: none"> <li>• For all sport floors</li> </ul> <p><b>Packaging</b>            2 cans of 5 L, for a total of 10 L</p>	<ul style="list-style-type: none"> <li>• Suited to all types of floors treated with Protecsof®</li> <li>• Easy and quick to use</li> </ul> <p><b>Packaging</b>            unit</p>
<b>Tips</b>	<ul style="list-style-type: none"> <li>• Edge to edge installation</li> <li>• Strips can be secured with single-sided adhesive tape AT7</li> </ul>	<ul style="list-style-type: none"> <li>• Traciflex may be sprayed on stubborn stains</li> </ul>		

Colours and images are not contractual.

### DOUBLE SIDED TAPES FOR SPORT FLOORS

Description	AT7	TARAFIX SL
<p>ADHESIVE TAPE FOR SMOOTH SURFACES</p>  <p><b>H1050001</b></p> <p>DOUBLE-SIDE TAPE FOR SMOOTH SURFACES LIKE VARNISHED PARQUET OR PVC SPORTS FLOORS</p>	 <p><b>H206 0001</b></p> <p>SINGLE-SIDE TAPE</p>	 <p><b>06480001</b></p> <p>HOLDING STRIPS FOR TARAFLEX® SL SOLUTIONS</p>
Width: 96 mm	Width: 100 mm	Width: 96 mm
<p>Adapted to temporary installation</p> <p>Requires a test on site for validation</p>	<p>Black</p> <p>Bonds without leaving marks, non migrating</p> <ol style="list-style-type: none"> <li>Holds strips during non sportive events</li> <li>Enables the material to be secured on the tube at the time of winding</li> <li>Holds strips during the storage time</li> </ol>	<p>Reinforced tape: durable</p> <p>Easy to position</p> <p>No transfer to surface underneath</p> <p>Easy to remove without damaging the support</p> <p>Makes welding easier</p>
<p><b>Packaging</b></p> <p>0.096 × 45 lm roll (96 mm x 45 m)</p>	<p><b>Packaging</b></p> <p>0.1 × 33 lm roll (100 mm x 33 m)</p>	<p><b>Packaging</b></p> <p>0.096 × 25 lm roll</p>
<p>Required material:</p> <ul style="list-style-type: none"> <li>Double side tape reel</li> <li>Unroller for double sided tapes H372001</li> </ul> 	<p>Required material:</p> <ul style="list-style-type: none"> <li>AT7 tape reel</li> <li>Unroller for single sided tapes H367 0003</li> </ul> 	<p>Required material:</p> <ul style="list-style-type: none"> <li>Unroller for single sided tapes H367 0003</li> </ul>
<b>Tips</b>		

Refer to the product glossary for information on colours and packaging

### STORAGE EQUIPMENT

Description	Article Code	Use
NAIROD PALLET (brand new)	087Q0057	For transportation and storage of mobile court (160 × 120 × 180)
NAIROD PALLET (2 <sup>nd</sup> hand)	087Q0057	

Description	Article Code	Use
SERVING TROLLEY Portable floors	088H0001	To wind and unwind Bateco or portable floors
SERVING TROLLEY Bateco	088F0001	

Description	Article Code	Use
STORAGE RACK FOR 4 ROLLS DPP4	087E0039	For BATECO storage
STORAGE RACK FOR 4 ROLLS DPP4	088N0001	For portable floors
STORAGE RACK FOR 6 ROLLS DPP6	088O0001	For BATECO storage
STORAGE RACK FOR 6 ROLLS DPP6	088K0001	For portable floors
STORAGE RACK FOR 8 ROLLS DPP8	087B0037	For BATECO storage
STORAGE RACK FOR 10 ROLLS DPP10	088J0001	For BATECO storage: Must be ordered with a frame extension pair
STATIC WALL STORAGE RACK	088E0001	

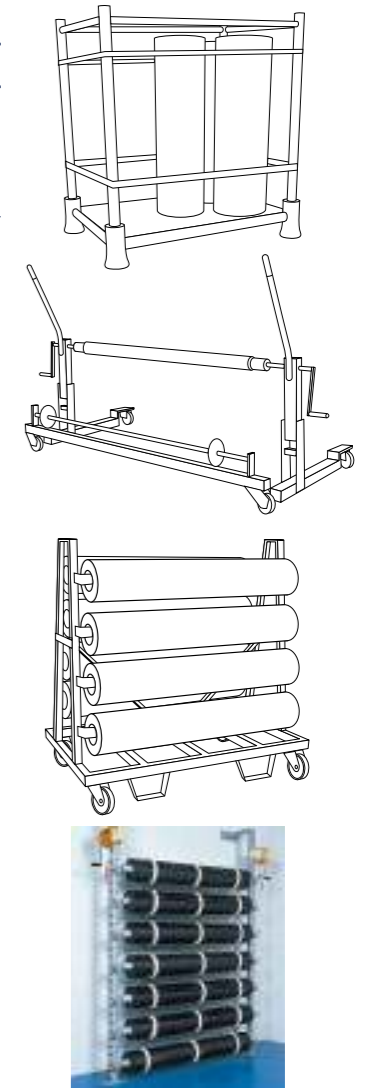

### ACCESSORIES

Description	Article code	Use
MOTORISED UNWINDING KIT	088G0001	Motorised system to easily wind and unwind Bateco or sports floors
HOLDING STRAP	H2950001	Holding strap to prevent roll unwinding Use 2 for a 1.5m roll
FRAME EXTENSION PAIR	087G0042	The frame extension pair is only to support the roll hoist. It enables the lifting of rolls to the highest position on roll stands
ROLL HOIST PAIR	H4000012	Indispensable device for easy upload or download of rolls

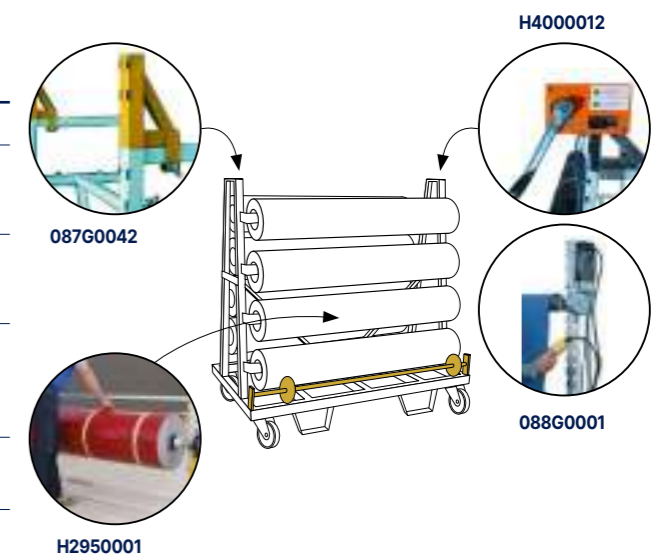



# Specifications

pages 364-371

## 366. Gerflor specifications









# Notes

# Gerflor web site

New design,  
New navigation!



A website you can access on your tablet  
or smartphone everywhere!



Follow us on social media!

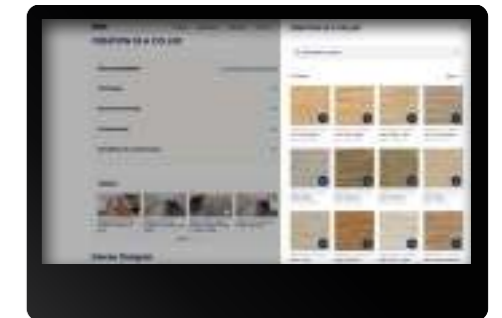

**1 Virtual library**  
Access to all commercial and technical documentation that will help you developing your projects.





**2 Interior designer**  
The Interior Designer provide you a real time simulation of the floor selected either in your own photo or in a pictures' gallery.



**3 Store locator**  
Access to our distributor partners list and select the closest one.



## We care / we act our commitments for 2030

 <p><b>climate</b></p> <p><b>-30% CO<sub>2</sub></b> scopes 1, 2, 3 in tons eq. CO<sub>2</sub>, vs 2019 Science Based Targets<sup>(1)</sup></p>	 <p><b>resources</b></p> <p><b>75%</b> biobased, mineral and recycled content<sup>(2)</sup></p> <p><b>30%</b> recycled content<sup>(3)</sup></p>	 <p><b>circularity</b></p> <p><b>65 000 tons</b> annual volume recycled<sup>(4)</sup></p> <p><b>45%</b> loose lay<sup>(5)</sup></p>	 <p><b>health &amp; well-being</b></p> <p><b>100%</b> products better than Indoor Air Quality standards<sup>(6)</sup></p> <p><b>95%</b> sales covered by EPD<sup>(7)</sup></p>	 <p><b>people</b></p> <p><b>30%</b> women<sup>(8)</sup></p> <p><b>40%</b> internal mobility<sup>(9)</sup></p> <p><b>Towards 0</b> accident<sup>(10)</sup></p>
--	---	--	---	--

**More details:** 1. Scopes 1, 2 & 3, in absolute value, market-based. Trajectory approved by SBTi (Science Based Targets Initiative). 2. Origin of raw materials for the entire Floor & Wall portfolio, on average, by weight; including 15% virgin salt, a primary element in vinyl manufacturing. Compared to 71% in 2024. 3. Average content in the Floor & Wall vinyl portfolio, by weight. Compared to 21% in 2024. 4. Recycled in our factories and recycling units. Compared to 59 040 tons in 2024. 5. % of Floor activity with non-glued products, easy to remove, easy to re-use. Compared to 40% in 2024. 6. 100% of vinyl and linoleum sold to the building market below 100 micrograms /m<sup>2</sup> (TVOC 28 days). 7. % of Floor & Wall activity covered by Environmental Product Declarations (EPD). Compared to 44% in 2024. 8. % women in our global workforce and among our managers. Compared to respectively 26% and 27% in 2024. 9. % job openings filled with internal hires worldwide. Compared to 25% in 2024. 10. Towards 0 accident: Lost time accident per million hours worked: below 3 vs 8,9 in 2024, for Gerflor employees worldwide.

